

# The ATmega2560 Microcontroller

Or: There and Back Again

Group 8

# What/Where is it?



ARDUINO  
MEGA 2560 REV3

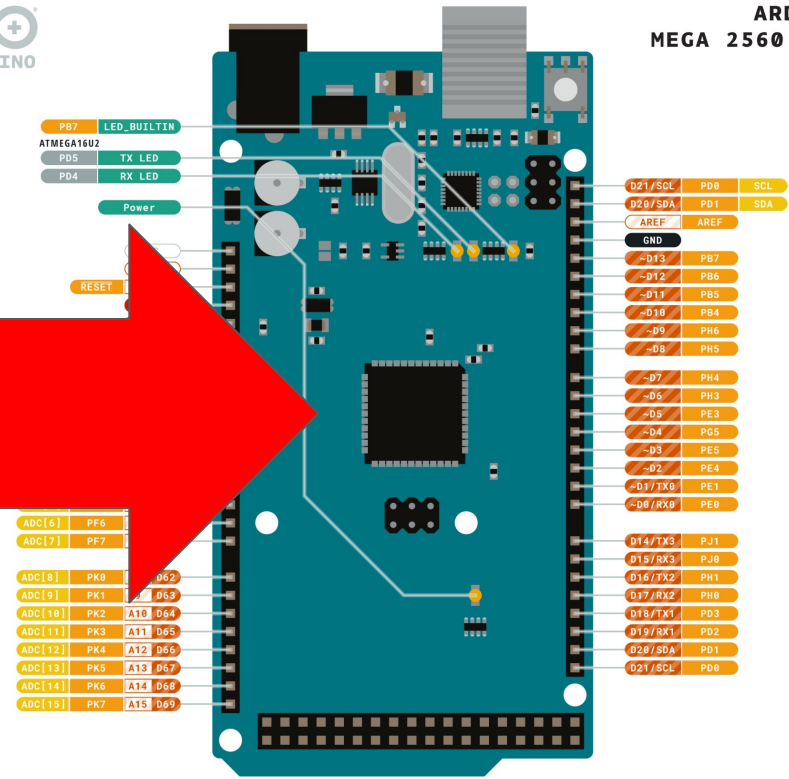
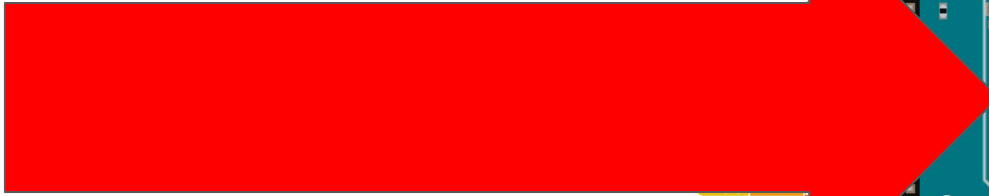

- Ground
- Internal Pin
- Digital Pin
- Microcontroller's Port
- Power
- SWD Pin
- Analog Pin
- LED
- Other Pin
- Default

# Specs

Flash	EEPROM	RAM	General purpose I/O pins	16 Bit PWM Channels	Serial USARTS	ADC Channels
256KB	4KB	8KB	86	12	4	16

write/erase cycles: EEPROM 100,000/ flash 10,000

Speed grade: 0 - 16MHz @ 4.5V - 5.5V

Data retention: 20 years at 85°C/ 100 years at 25°C

Digikey Price: ~\$18 (for 1 unit)

# Comparison

The ATmega2560 is on the higher end of chips used in Arduinos, illustrated by comparison with the most popular Arduino, the Arduino Uno, which uses the ATmega328P.

	ATmega328P	ATmega2560
Flash Memory	32 KB	256 KB
EEPROM	1 KB	4 KB
Programmable I/O Lines	23	86
Internal SRAM	2 KB	8 KB
Speed	16 MIPS at 16MHz	16 MIPS at 16MHz

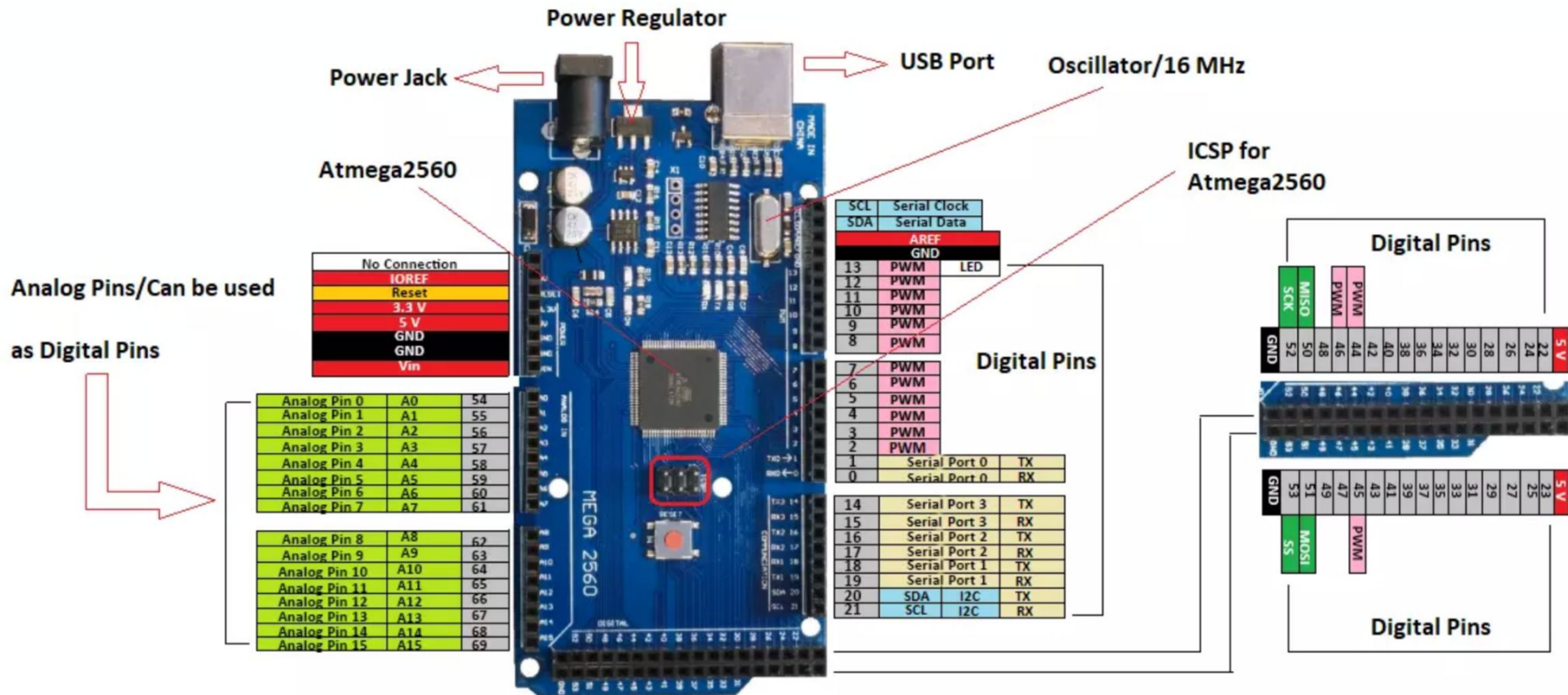

**Arduino Mega 2560 Pinout**

# Features

- High Performance, Low Power Atmel® AVR® 8-Bit Microcontroller
- Advanced RISC Architecture
- High Endurance Non-volatile Memory Segments
- Atmel® QTouch® library support
- JTAG (IEEE® std. 1149.1 compliant) Interface

# RISC Architecture

135 Powerful Instructions – Most Single Clock Cycle Execution

32 × 8 General Purpose Working Registers

Fully Static Operation

Up to 16 MIPS Throughput at 16MHz

On-Chip 2-cycle Multiplier

# Atmel® QTouch® library support

- Capacitive touch buttons, sliders and wheels
- QTouch and QMatrix acquisition
- Up to 64 sense channels



# JTAG (IEEE® std. 1149.1 compliant) Interface

- Boundary-scan Capabilities According to the JTAG Standard
- Extensive On-chip Debug Support
- Programming of Flash, EEPROM, Fuses, and Lock Bits through the JTAG Interface

# Supporting Hardware and Shrinking Arduino Projects

## Arduino Mega 2560 Reference Design

Reference Design ARE PROVIDED "AS IS" AND WITH ALL FAULTS. ARDUINO DISCLAIMS ALL OTHER WARRANTIES, EXPRESS OR IMPLIED, REGARDING PRODUCTS, INCLUDING BUT NOT LIMITED TO, ANY IMPLIED WARRANTIES OF MERCHANTABILITY OR FITNESS FOR A PARTICULAR PURPOSE.

Arduino may make changes to specifications and product descriptions at any time, without notice. The Customer shall not rely on the absence or characteristics of any hardware or equipment that is not tested or certified by Arduino. Arduino reserves the right to discontinue or alter specifications at any time without notice. The product information on this web site or in this document is subject to change without notice. Do not purchase a design with this information.

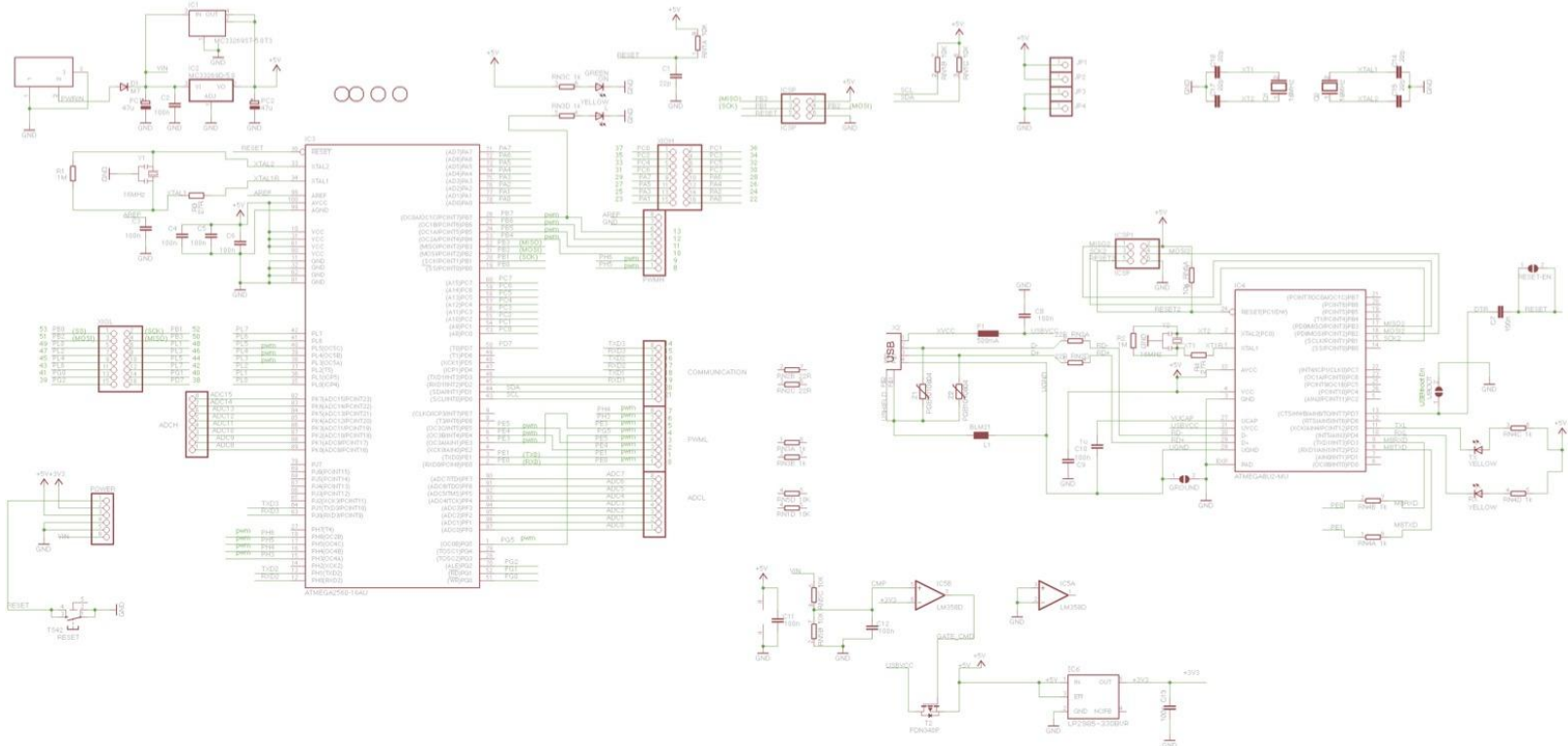

# Minimal Hardware Requirements

- 16 MHz crystal resonator
- Some capacitors
- Some resistors
- LEDs (if you want to be fancy)



- CP2102 USB to UART TTL Module
- Another arduino (for programming the bootloader)

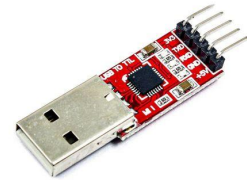

© Photo by ElectroPeak

# Smaller/Specific Hardware

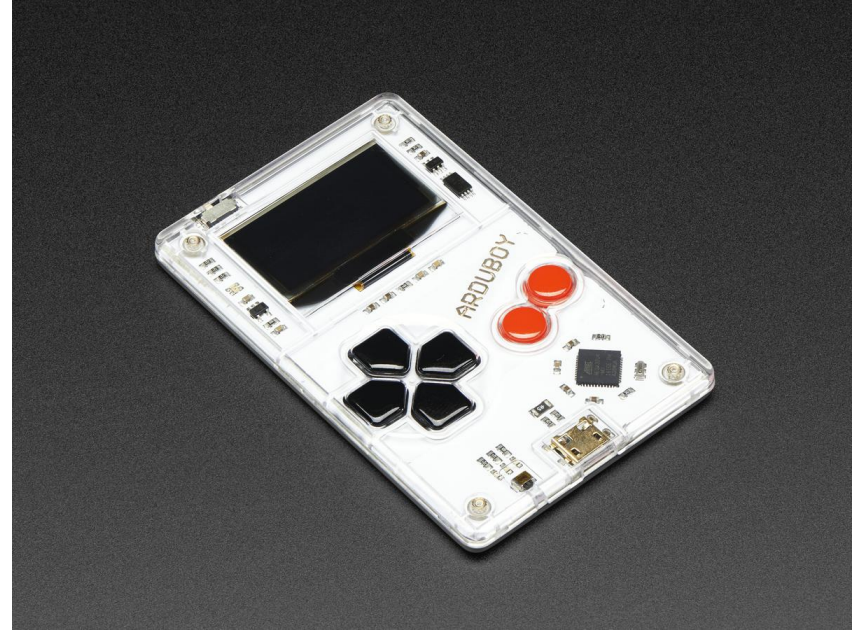
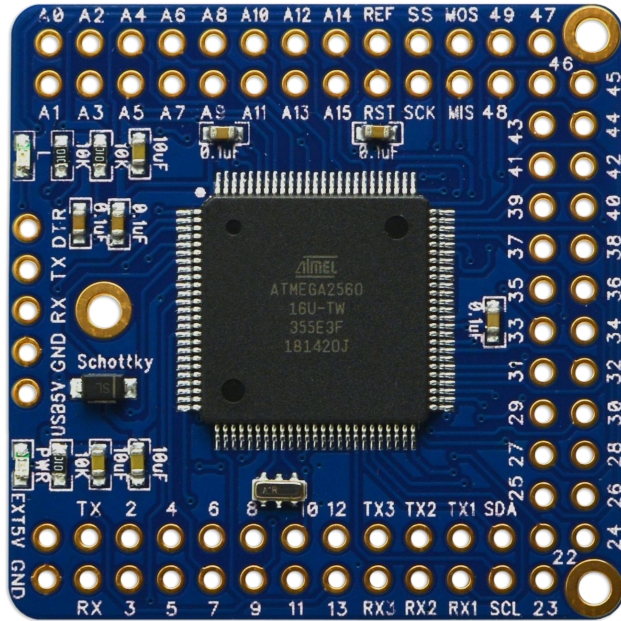

# Sources:

ATMEL ATmega2560 datasheet:

[https://ww1.microchip.com/downloads/en/devicedoc/atmel-2549-8-bit-avr-microcontroller-atmega640-1280-1281-2560-2561\\_datasheet.pdf](https://ww1.microchip.com/downloads/en/devicedoc/atmel-2549-8-bit-avr-microcontroller-atmega640-1280-1281-2560-2561_datasheet.pdf)

Deconstructed Arduino Mega: <https://www.instructables.com/DIY-Bare-Minimum-Arduino-Mega-2560/>

ATMEL ATmega328P datasheet:

[http://ww1.microchip.com/downloads/en/DeviceDoc/Atmel-7810-Automotive-Microcontrollers-ATmega328P\\_Datasheet.pdf](http://ww1.microchip.com/downloads/en/DeviceDoc/Atmel-7810-Automotive-Microcontrollers-ATmega328P_Datasheet.pdf)

Digikey Product Page:

<https://www.digikey.com/en/products/detail/microchip-technology/ATMEGA2560-16AU/735455>