

Effective Lab Oral Reports

David Hertzog, Eugene V. Colla, Virginia O. Lorenz
University of Illinois at Urbana-Champaign
October 8, 2024

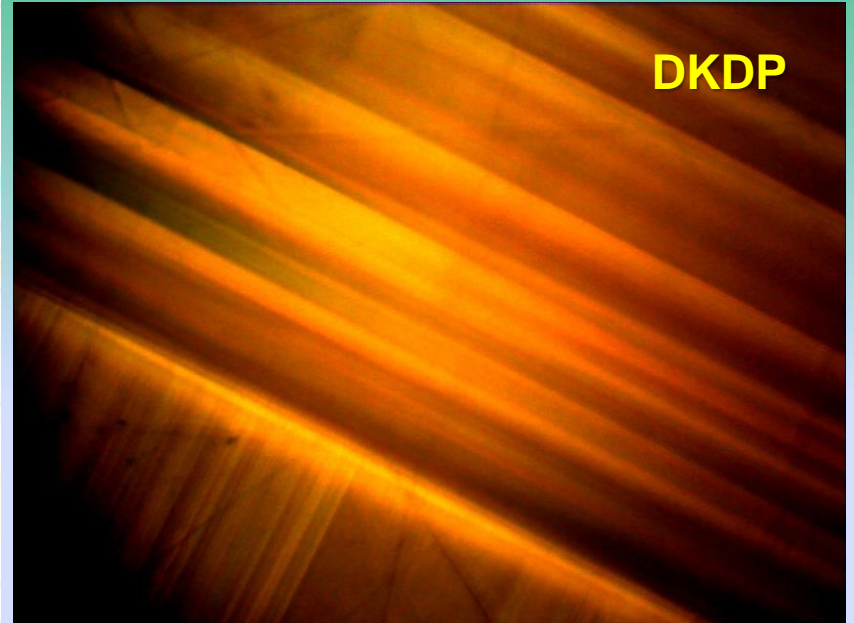

We will present some of our slides and many Phys 403 student slides as examples. We will talk about why they are or are not well-constructed examples.

All remarks about slides are in these red boxes

Include an eye-catching feature on title slide

This is a technical presentation, so you must develop it as a logical sequence

- What was the goal?
 - What physics did you address?
 - What technology?
 - Define your special vocabulary here
- What did you actually do?
 - Apparatus / Procedures / Raw Data
- What are your results?
 - Polished graphs, proofs, numerical findings
 - Principal difficulties and uncertainties
- Conclusions

Slide title tells what the slide is about. The rest of the slide supports the assertion.

Fonts matter for projectors

Arial

Comic Sans

Times

Courier

For online talks using sans serif font is not important -- computer monitors have much better resolution than screen projectors.

Choose readable font sizes and slide backgrounds

Write titles in size 32 bold

Write body text in size 18-20

Write comments / citations in size 14

Choose readable font sizes and slide backgrounds

Write titles in size 32 bold

Write body text in size 18-20

Write comments / citations in size 14

Text is too dark!

Choose readable font sizes and slide backgrounds

Write titles in size 32 bold

Write body text in size 18-20

Write comments / citations in size 14

**Make good contrast
between text and
background**

Presentation components and grading scale

CRITERIA	Max. Score
Attended both days	5
Title was sent to instructor on time	3
First slide has appropriate title, name, affiliation, date	3
Scientific background, goal and motivation were clearly and correctly presented	20
Research activities were clearly and correctly presented	20
Results were clearly and correctly presented	20
Technical aspects: good balance of text and figures, good quality figures, appropriate citations, correct spelling, correct number of significant digits, etc.	20
Time management: good balance between Introduction-Procedure-Results-Analysis	3
Spoke clearly, at a good pace, loud enough, etc.	3
Finished on time and answered questions clearly and correctly	3
Total	100

Each speaker has 15 minutes, including questions.
We recommend 13 min. talk + 2 min. questions.

Title

OPTICAL STUDY OF FERROELECTRIC POTASSIUM DIDEUTERIUM PHOSPHATE (DKDP)

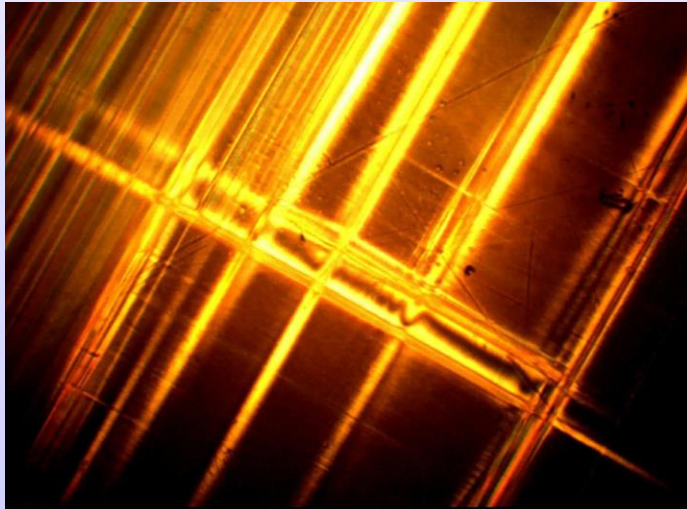

Eye-catching feature

Student name

Author name

University of Illinois at Urbana-Champaign

October 12, 2021

Affiliation

Date

Phase transition of Helium 4

- Below $T_\lambda = 2.17$ K, helium exists in mixture of superfluid and normal liquid helium

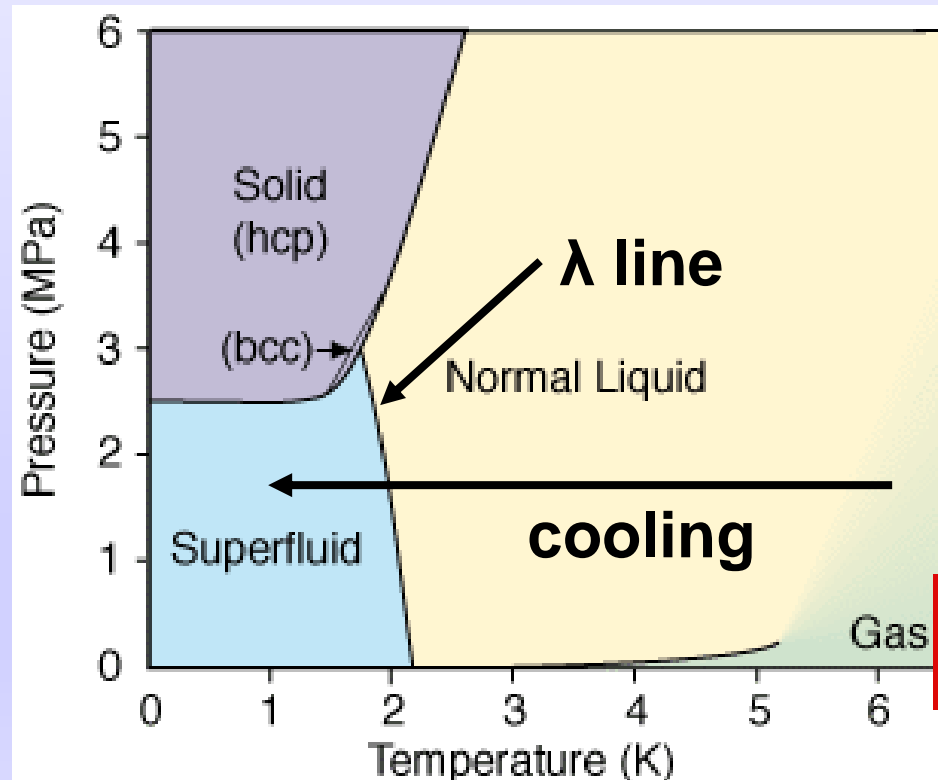

Page numbers are useful for questions

What happens if they are struck by pulses?

A pulse or a series of pulses is used to change the net magnetization of system. Pulsed NMR!

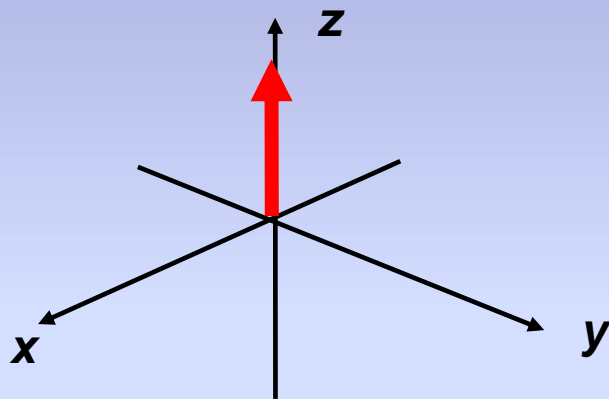
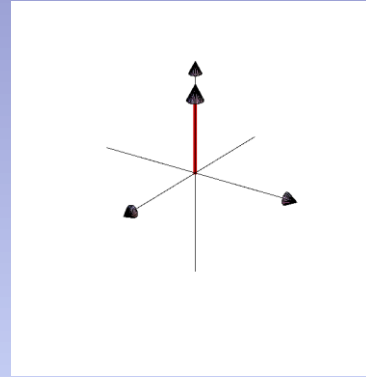

90° Pulse

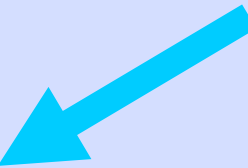
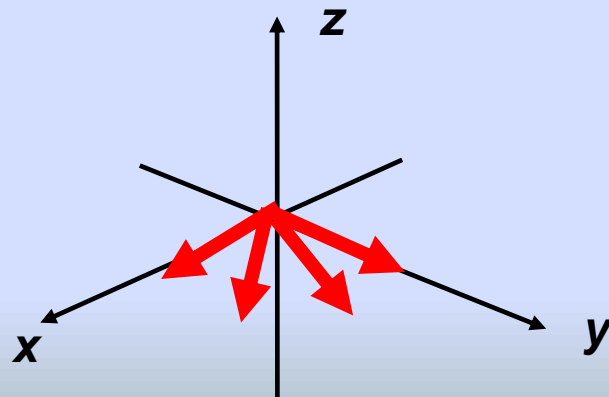
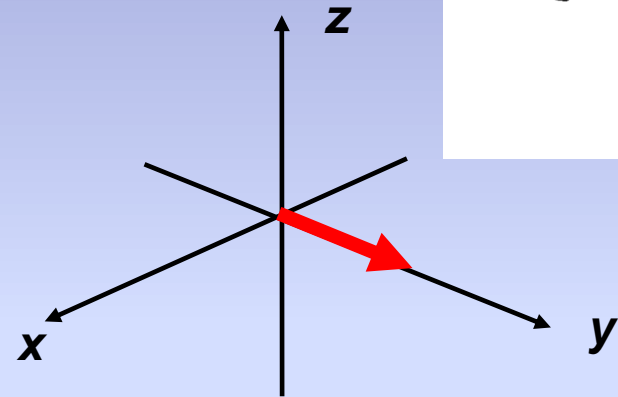
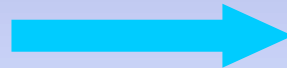

?

$$M(t) = M_0 e^{-\frac{t}{T_2}}$$

What happens to a nucleus in a magnetic field ?

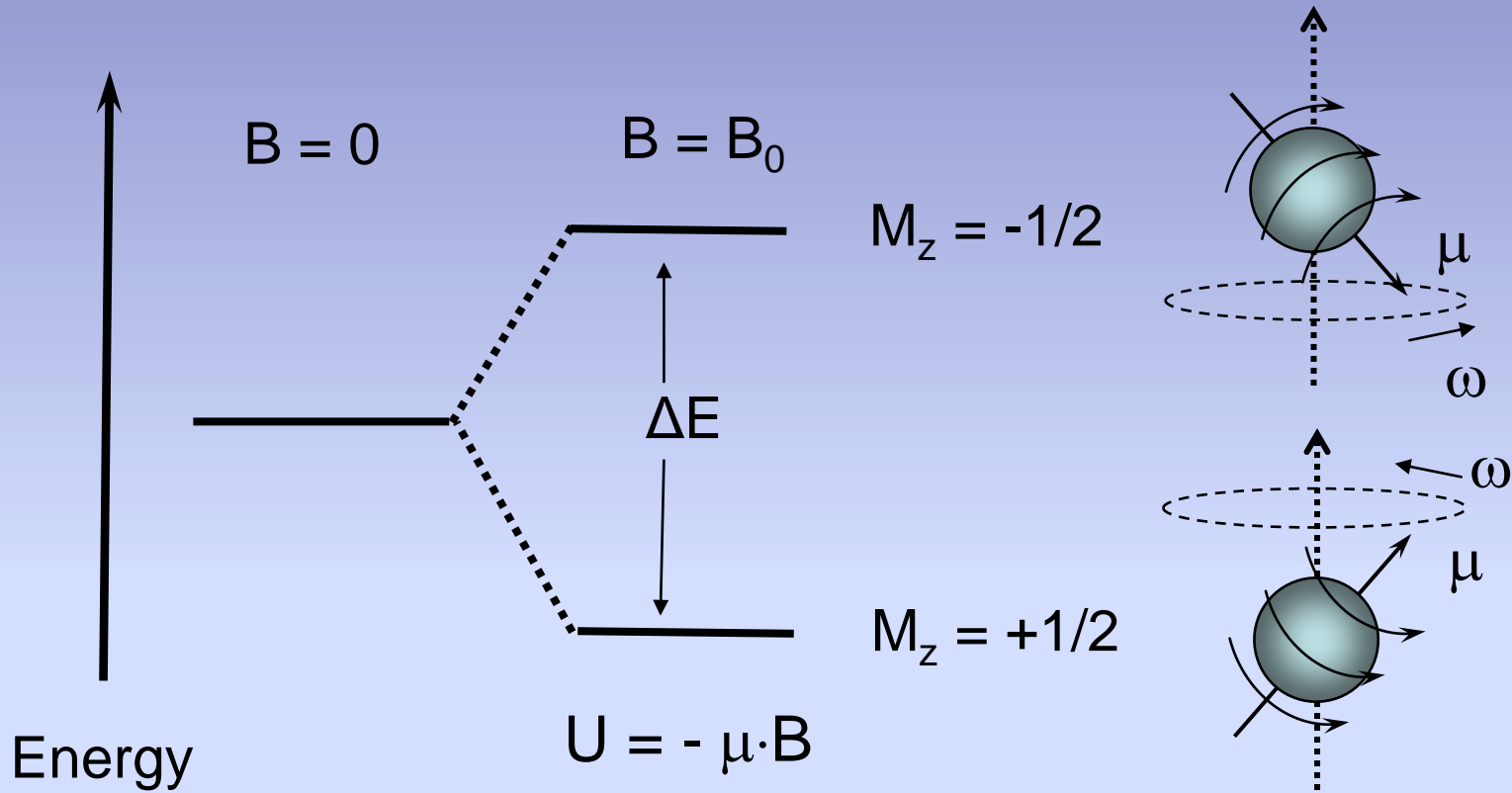

(Courtesy of Bishop. K)

$$\Delta E = \gamma \cdot \hbar \cdot B_0 = \hbar \omega_0 \rightarrow \text{Larmor frequency!}$$

Phase Transition in BaTiO₃

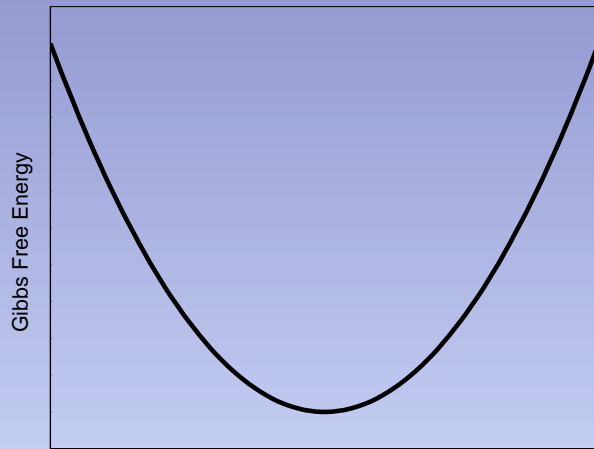

Polarization

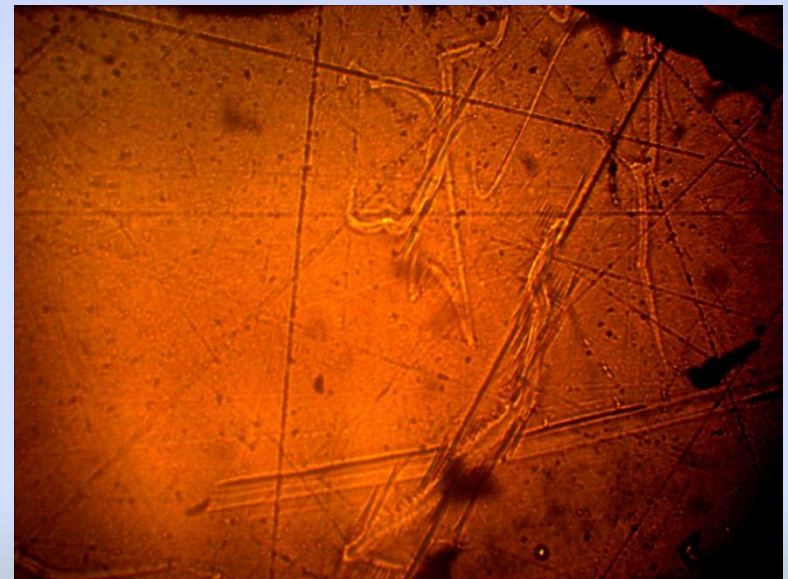
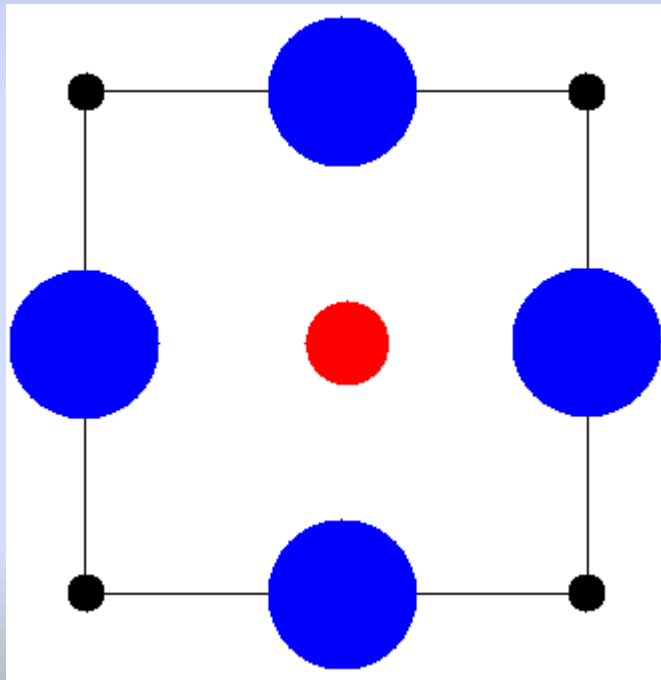
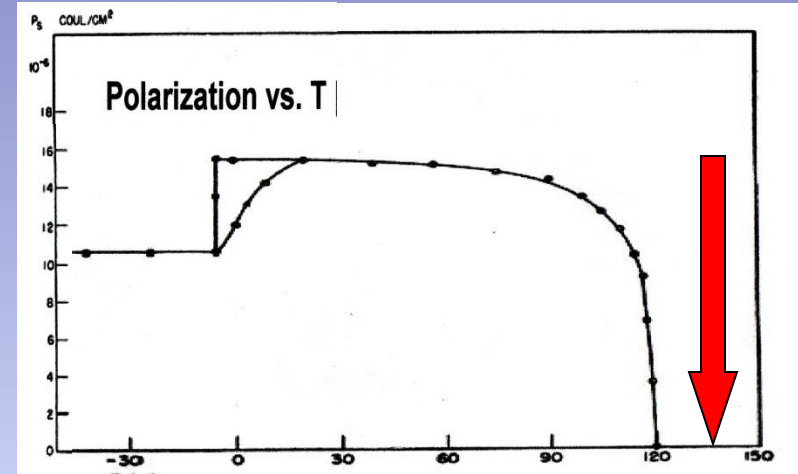

Phase Transition in BaTiO₃

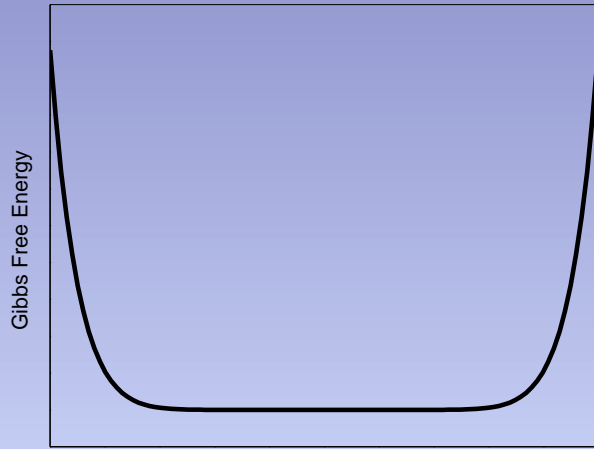

Polarization

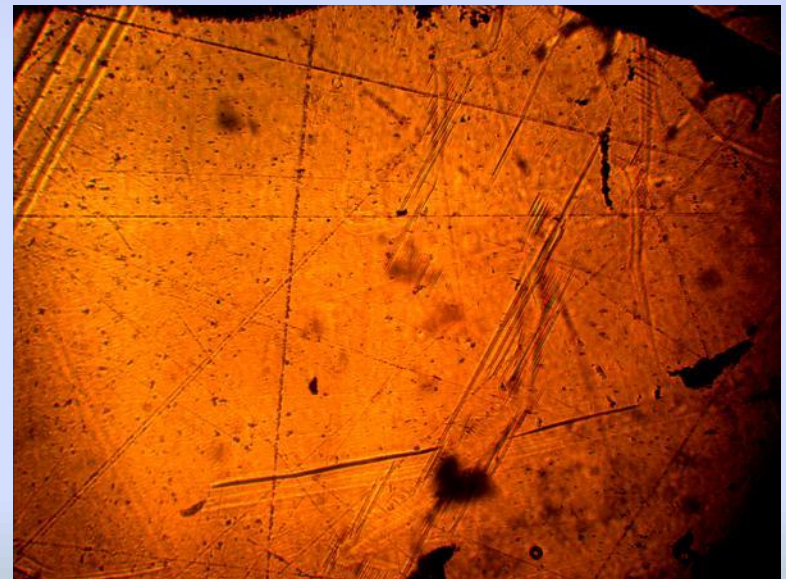
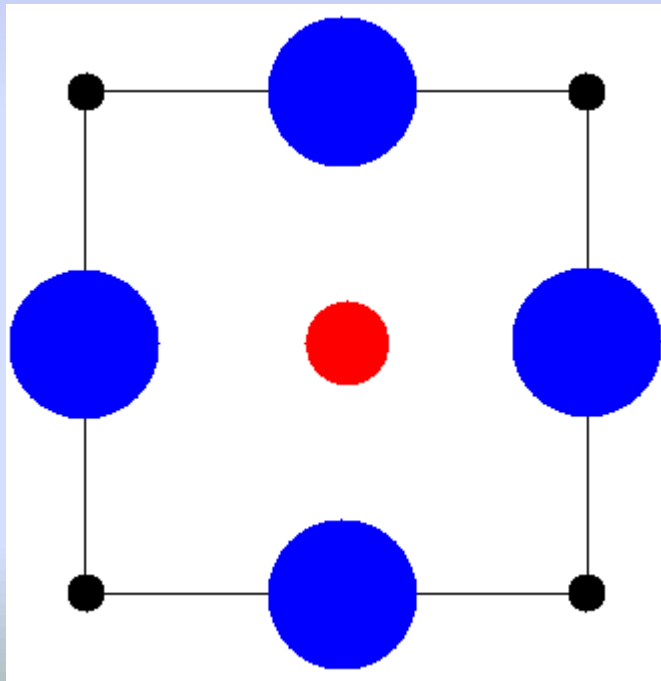
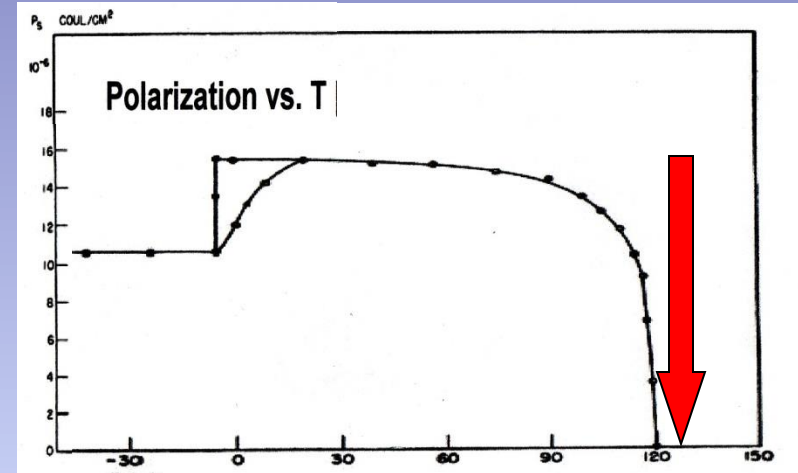

Phase Transition in BaTiO₃

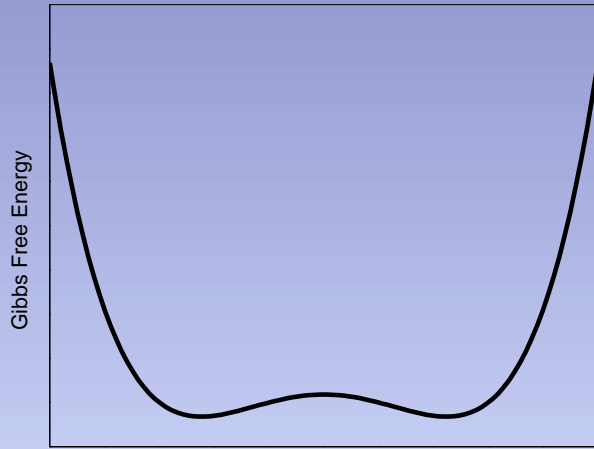

Polarization

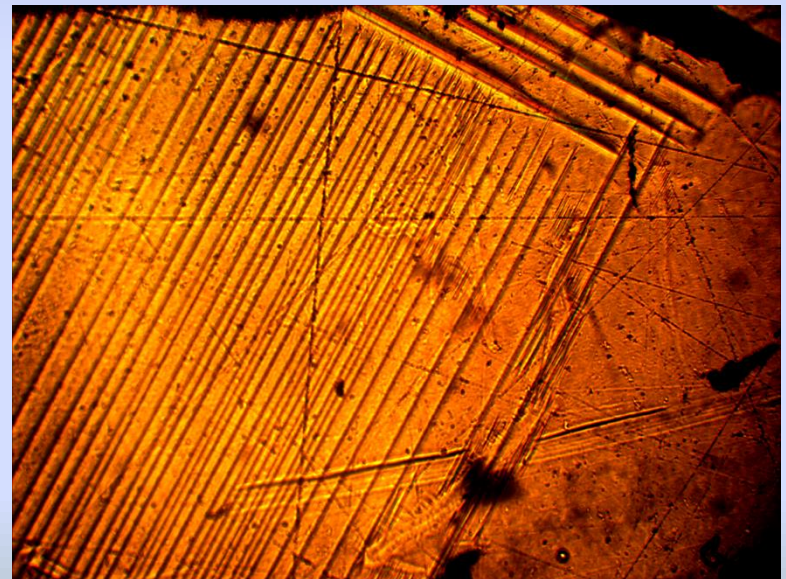
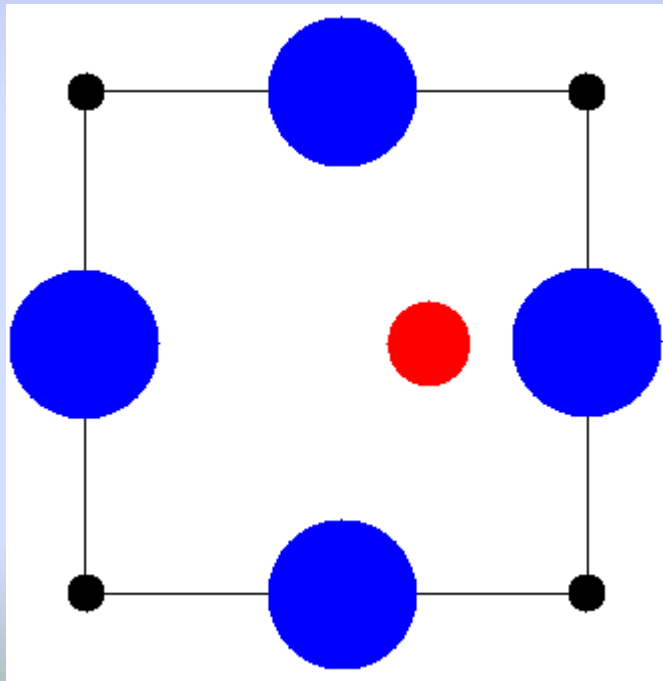
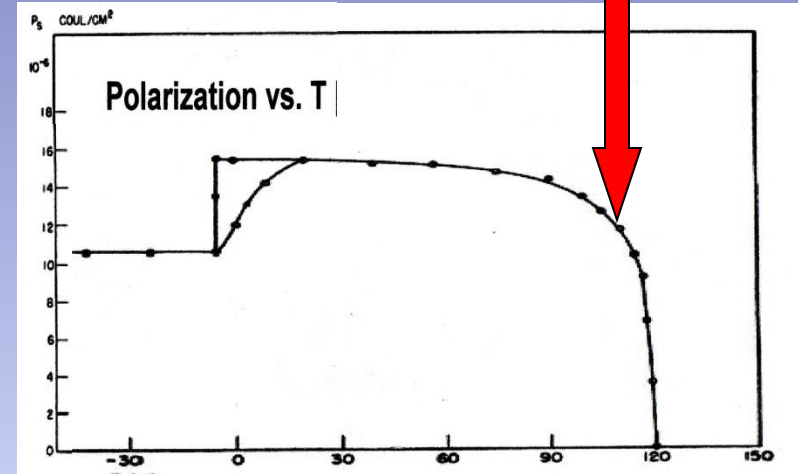

Phase Transition in BaTiO₃

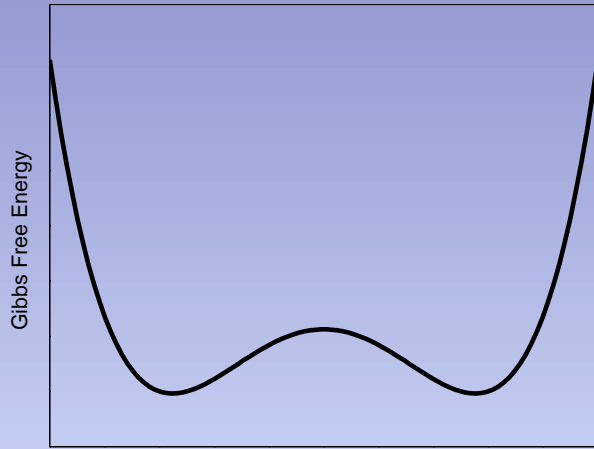

Polarization

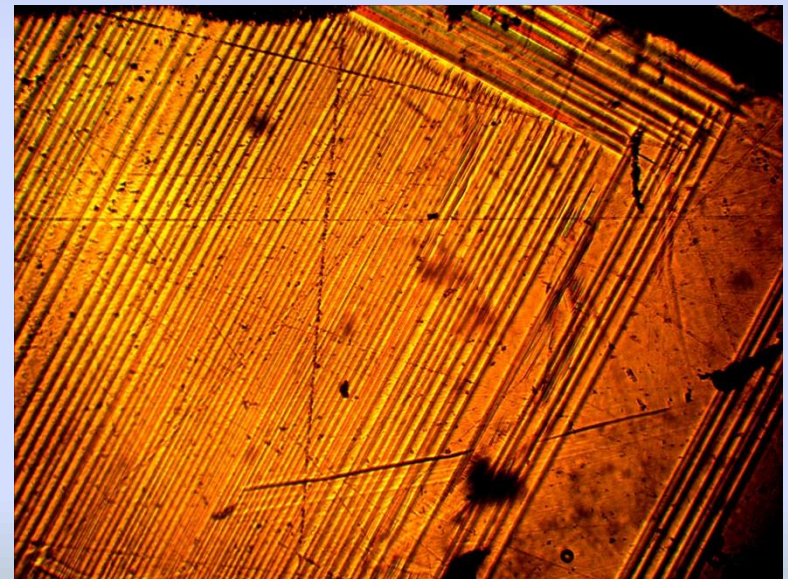
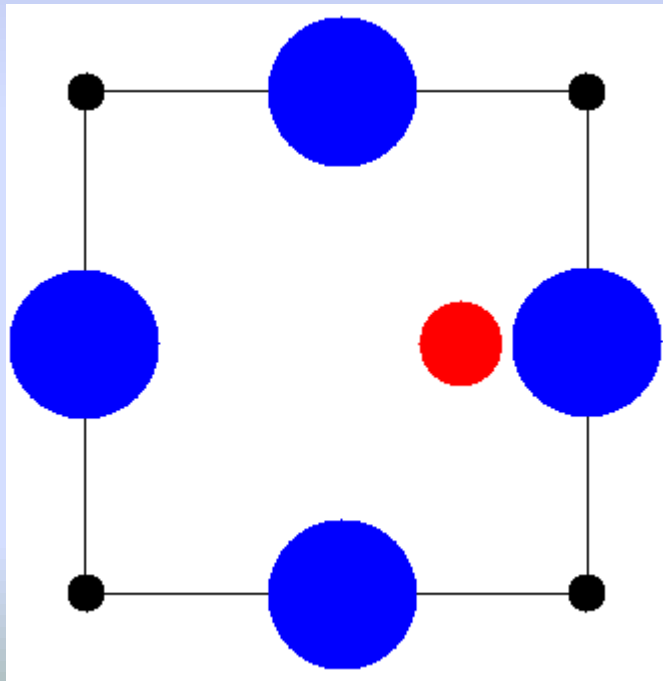
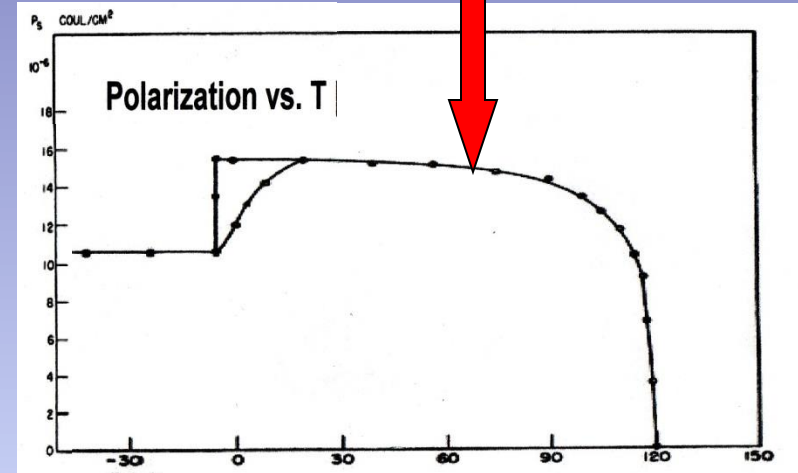

Setup diagrams, apparatus, measuring idea...

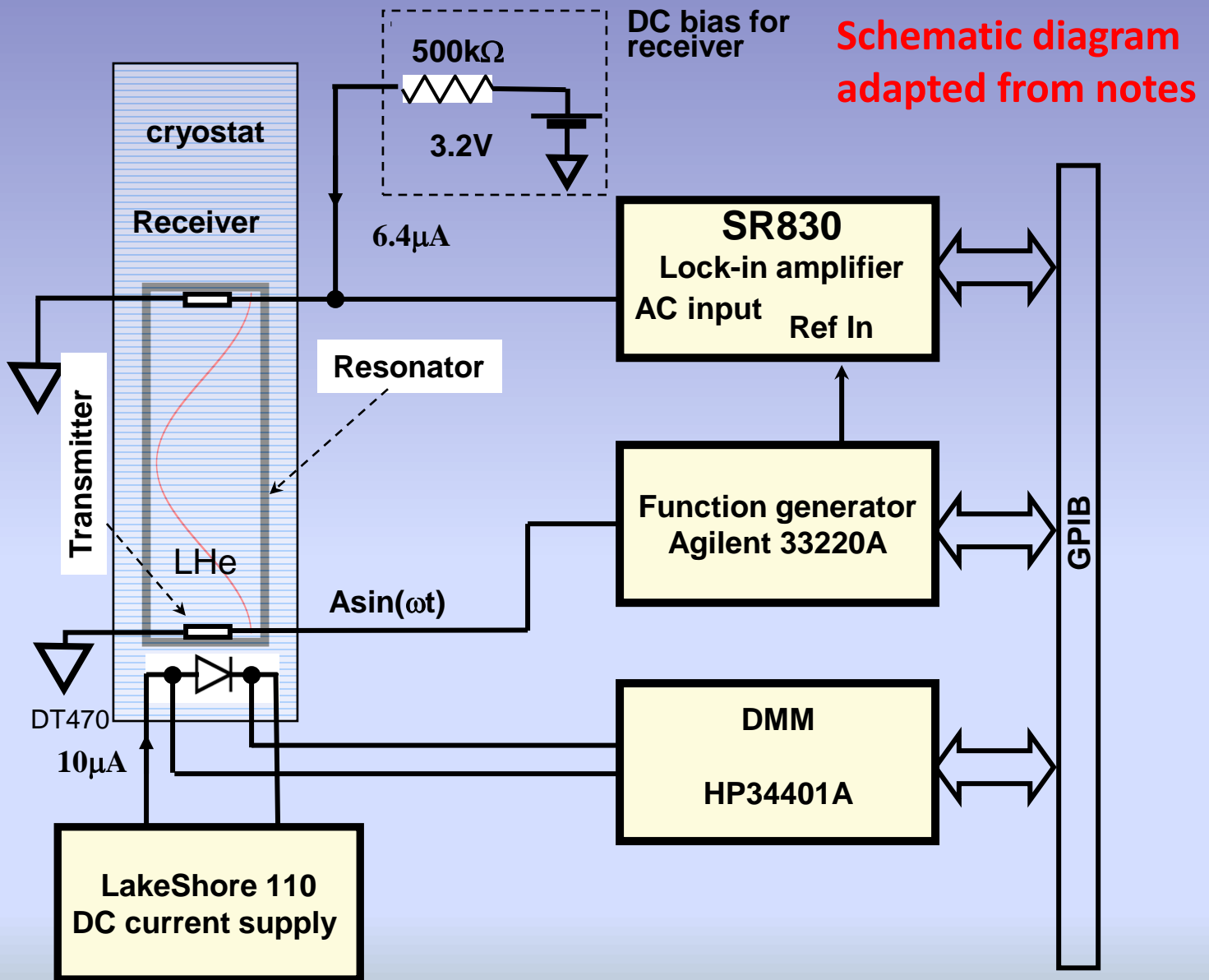

Everybody loves an optical bench, but unless you map out the elements and the beam paths, it doesn't mean much

Experimental Apparatus

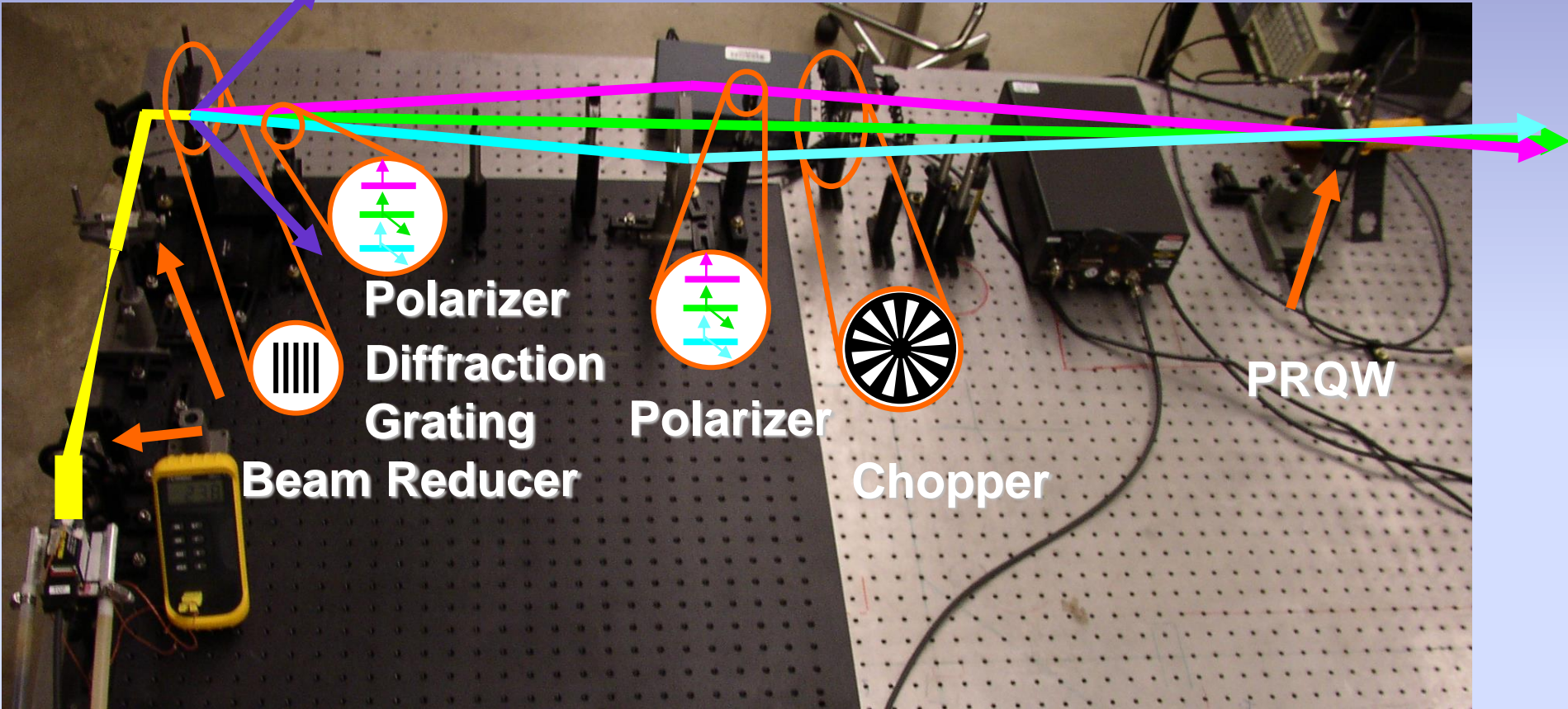

Example of an image that is not a good setup diagram without labels (but it can go on a title slide)



Setup of Source and Detectors

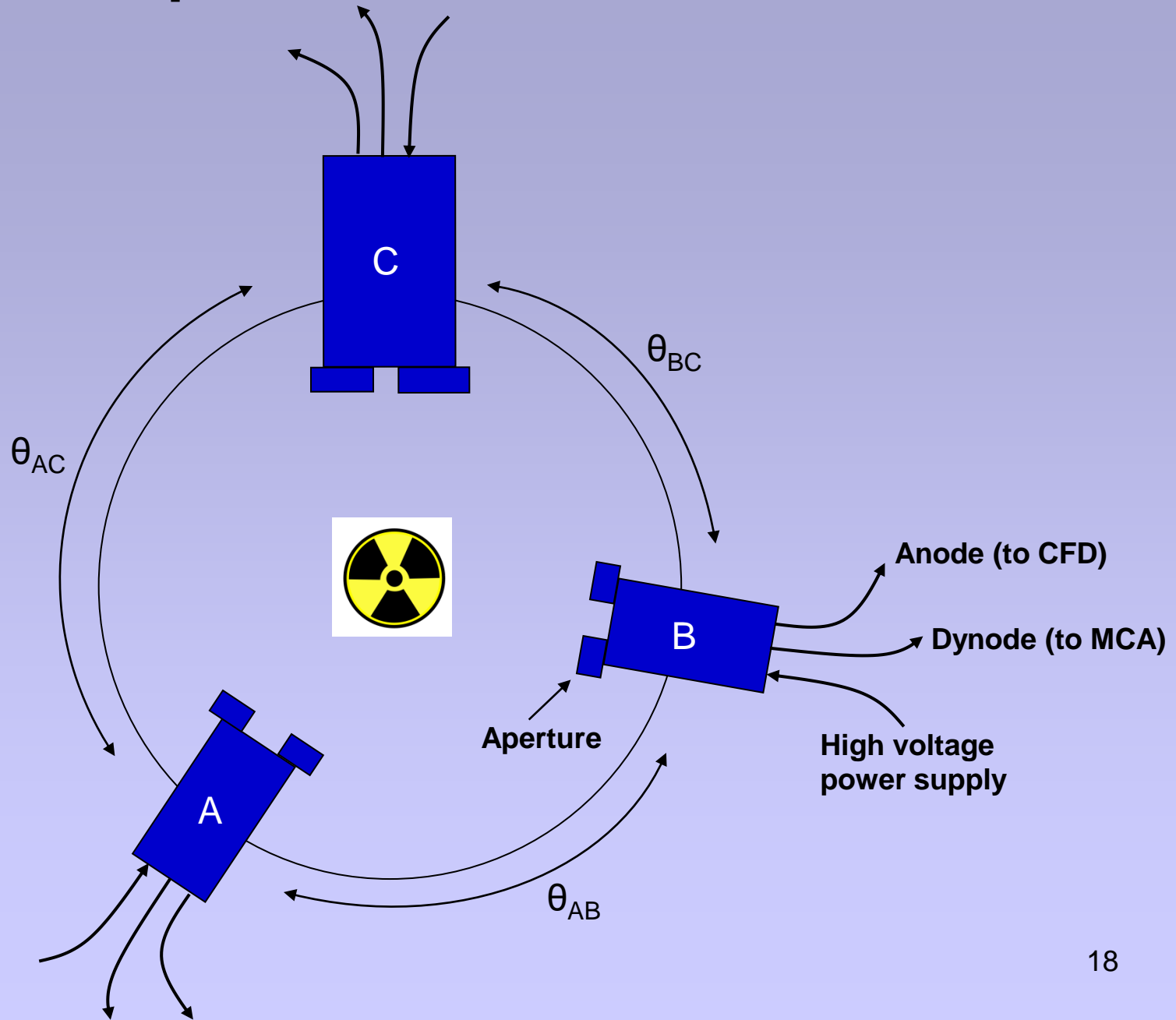

Samples: preparation, configuration etc.

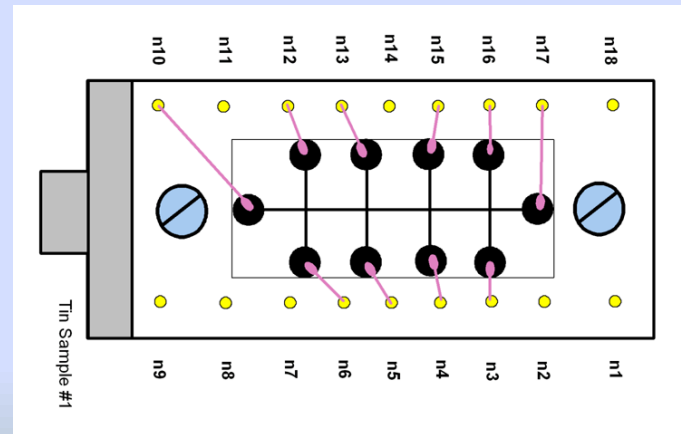
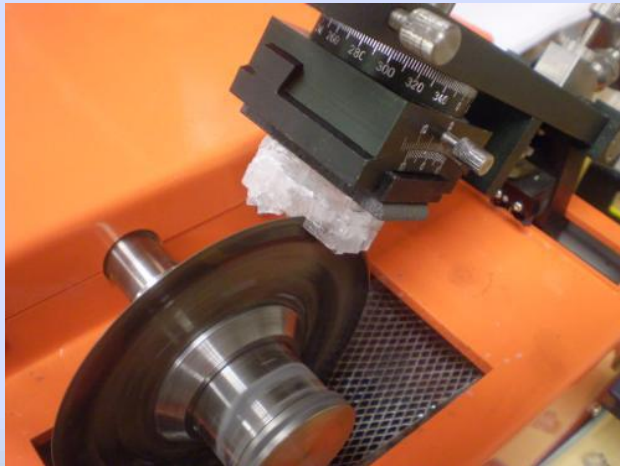
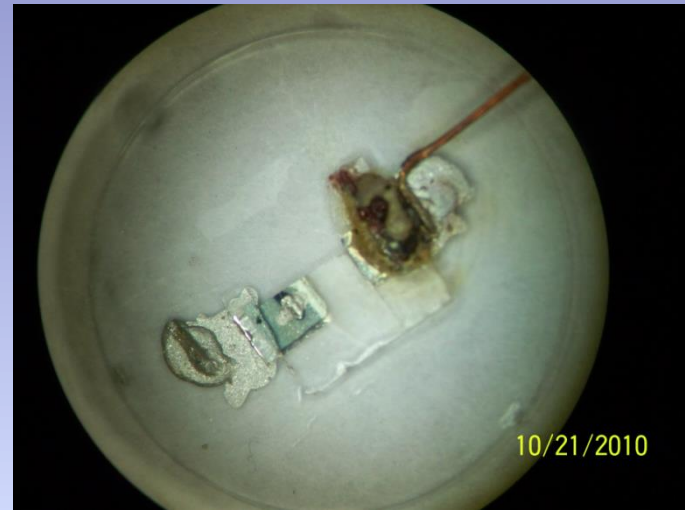
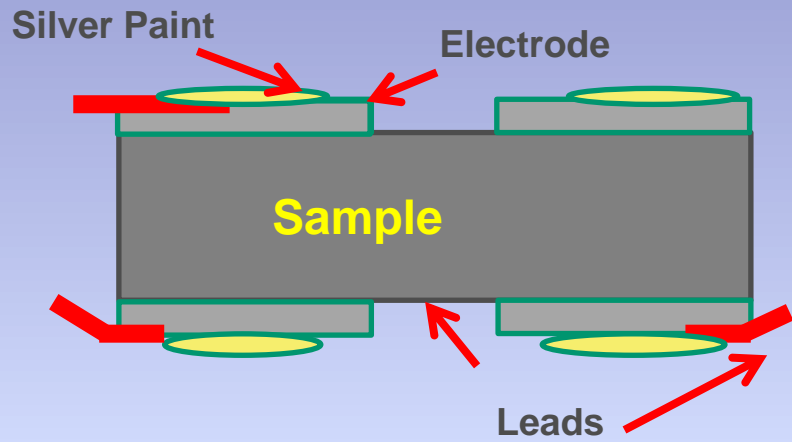

Presenting data is your most important and challenging task

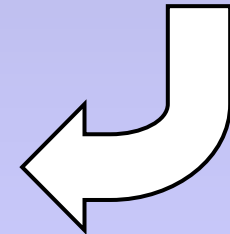
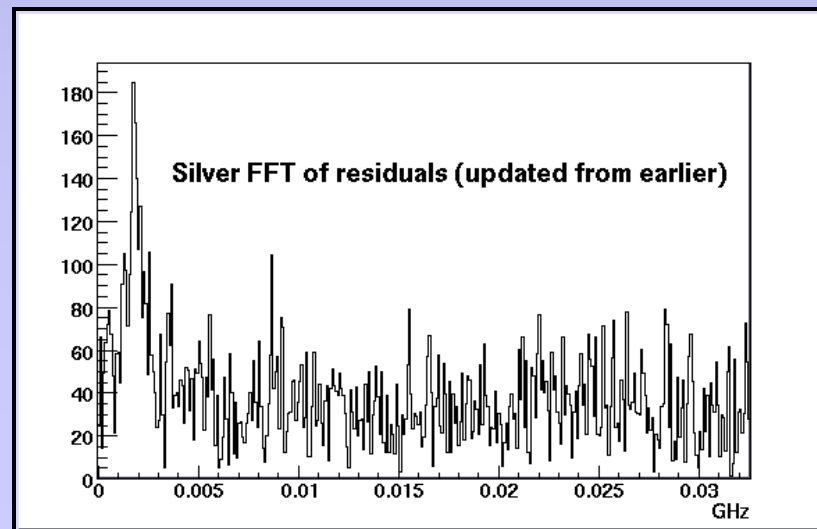
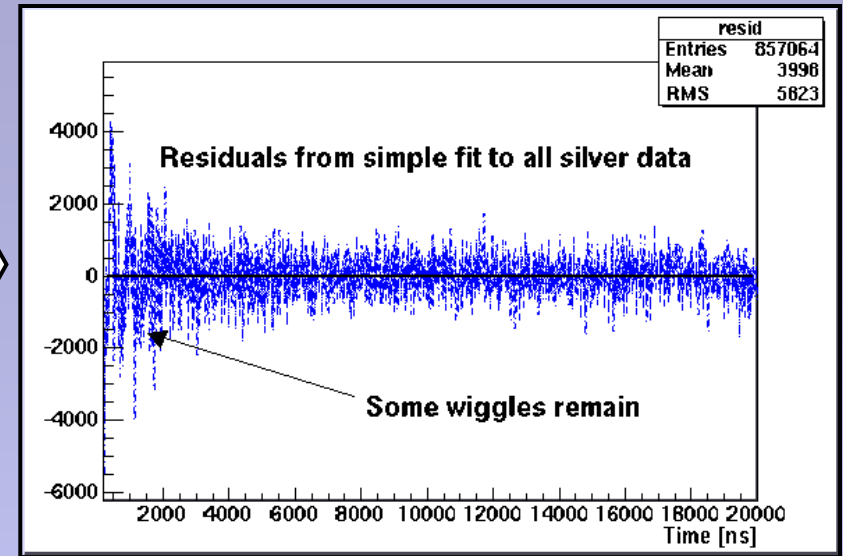
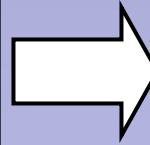
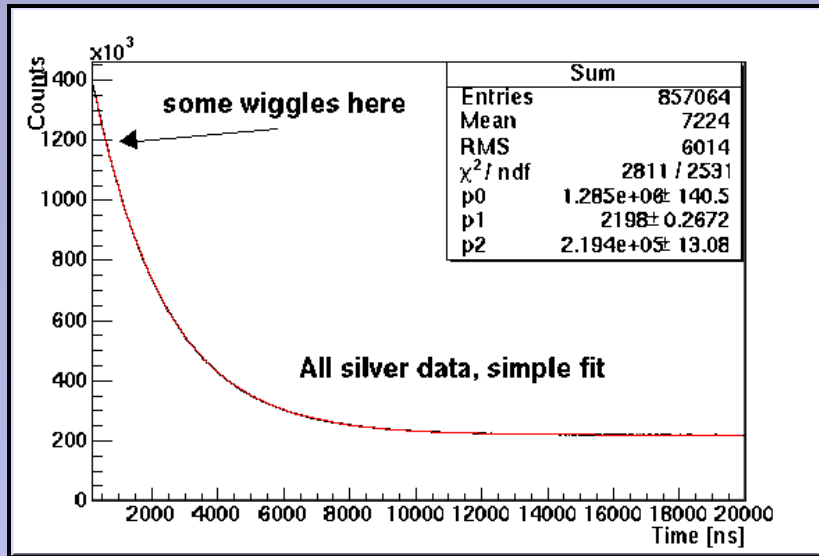

Examples of plots showing results

Raw tunneling data

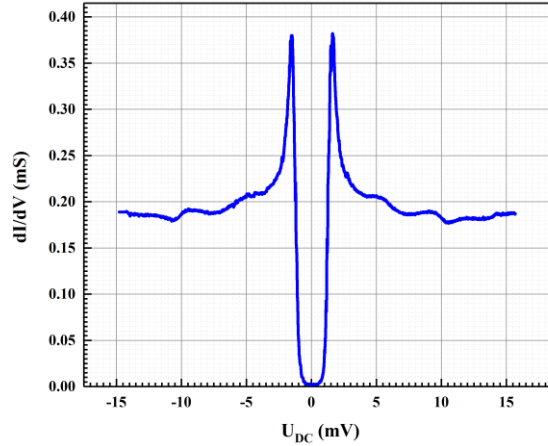

Energy gap derived from tunneling conductivity

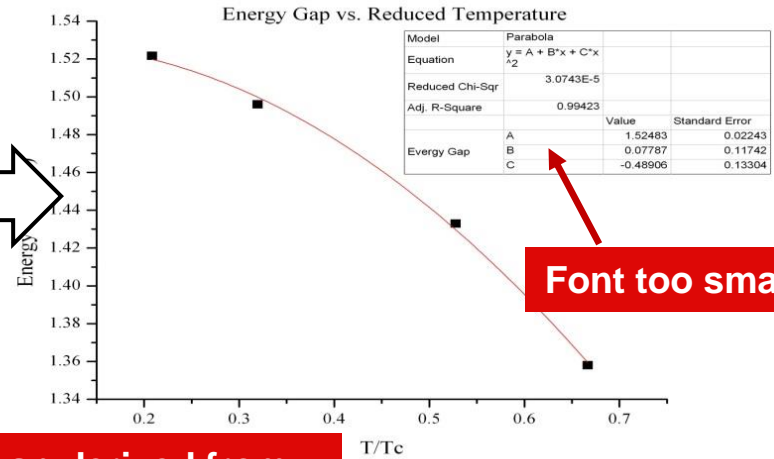

Count Rate vs. Pressure (Argon)

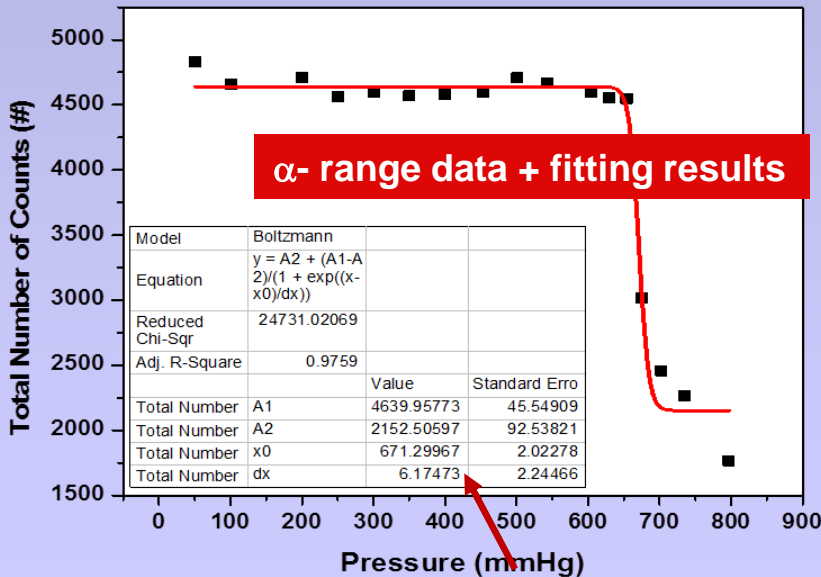

α - range data + fitting results

Too many significant digits!

Fluorescence data + fitting results

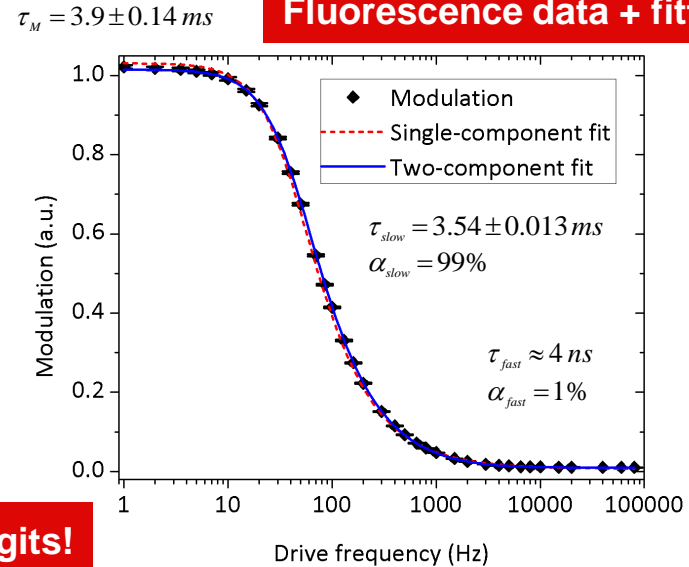

Difference in Up-Down (unnormalized)

Fit equation $N e^{\frac{-t}{\tau}} (1 + \alpha \cos(\omega t + \delta))$

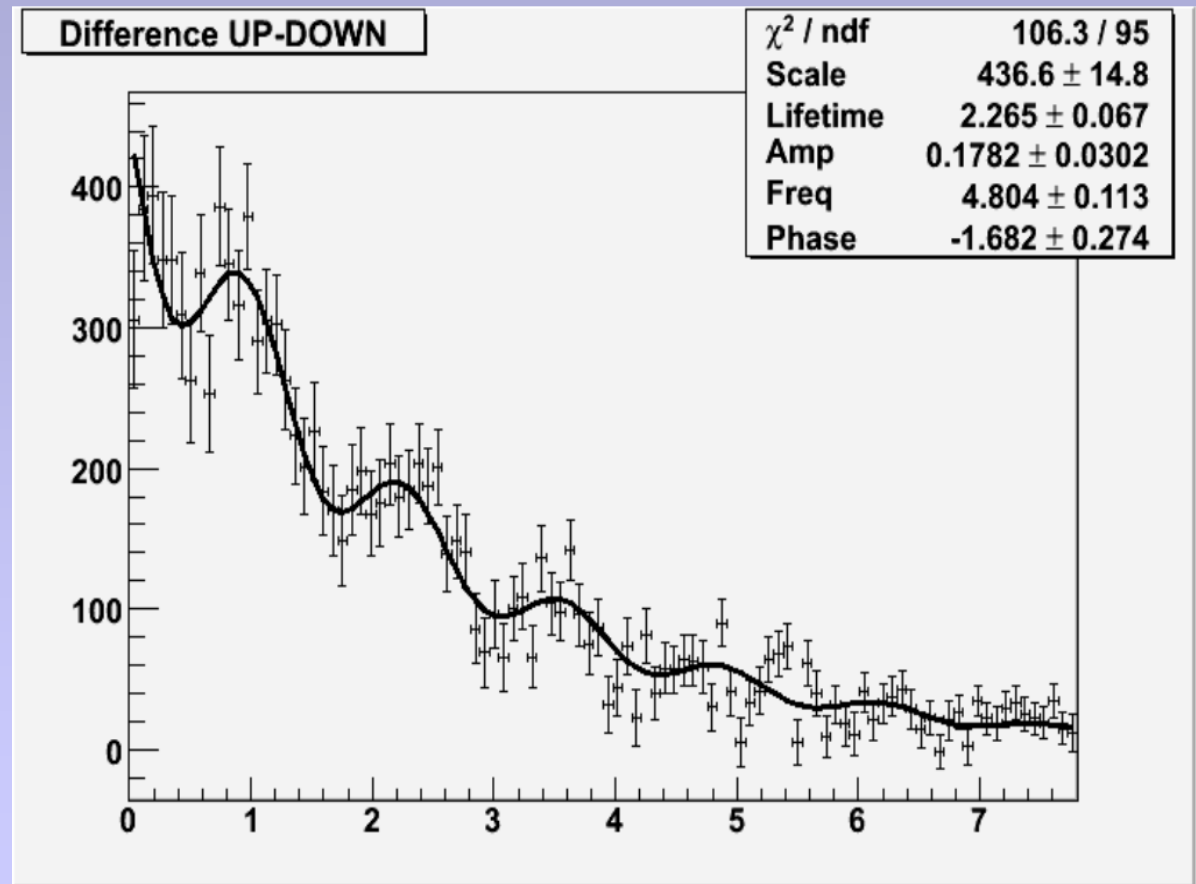

Put citations in the slide
where you use the image,
not at the end of the talk

Courtesy Samuel Homiller and
Pakpoom Buabthong Fall 2013

Difference in Up-Down (normalized)

Fit equation $Ne^{\frac{-t}{\tau}} (1 + \alpha \cos(\omega t + \delta))$

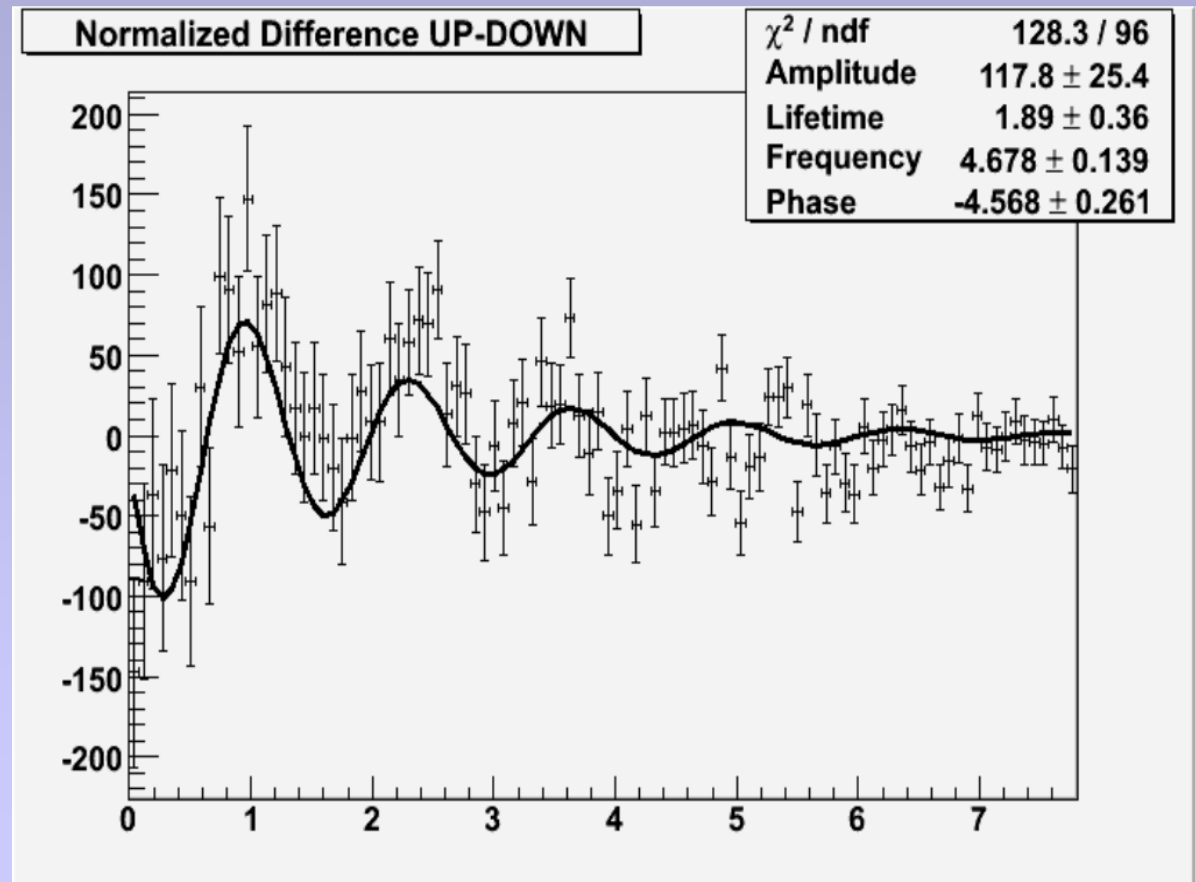

Courtesy Samuel Homiller and Pakpoom Buabthong Fall 2013

Results – witnessing a mystery?

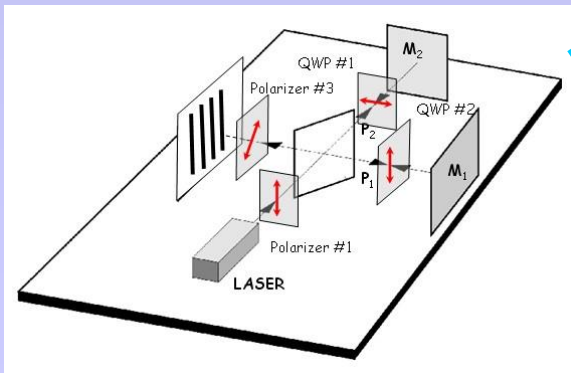
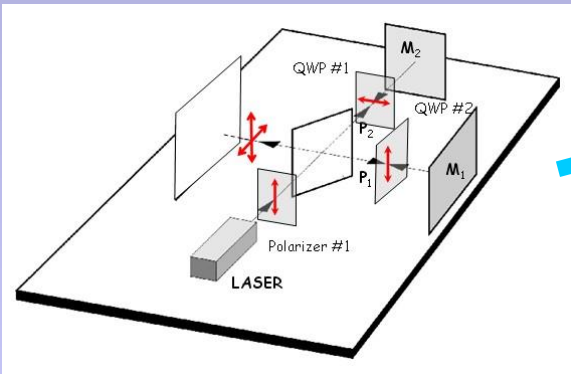
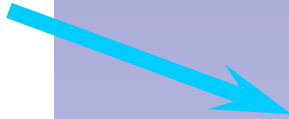
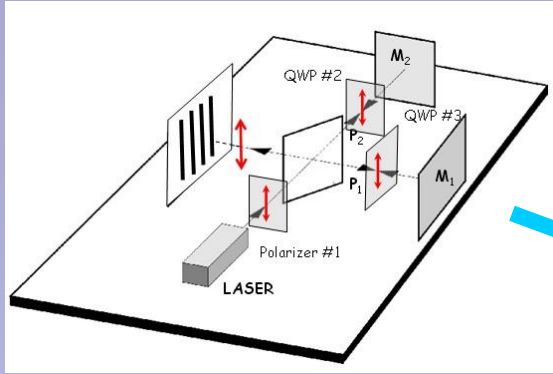

Fitting to the Curie-Weiss law

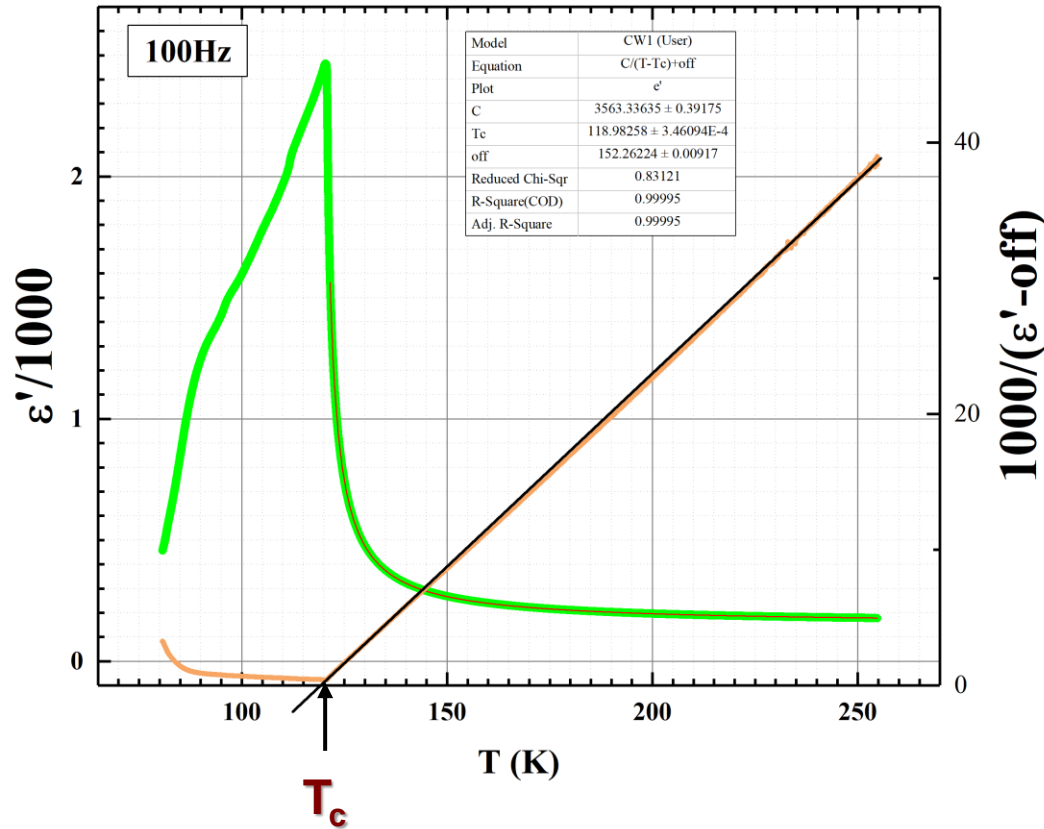

$$\epsilon' = \frac{C}{T - T_C} + off$$

$$C = 3563.3 \pm 0.4 \text{ K}$$

$$T_C = 118.9825 \pm 0.0003 \text{ K}$$

Courtesy Zongyuan Wang
and Arnulf Taylor Su 2017

AFM of Optical Data Storage Media

CD

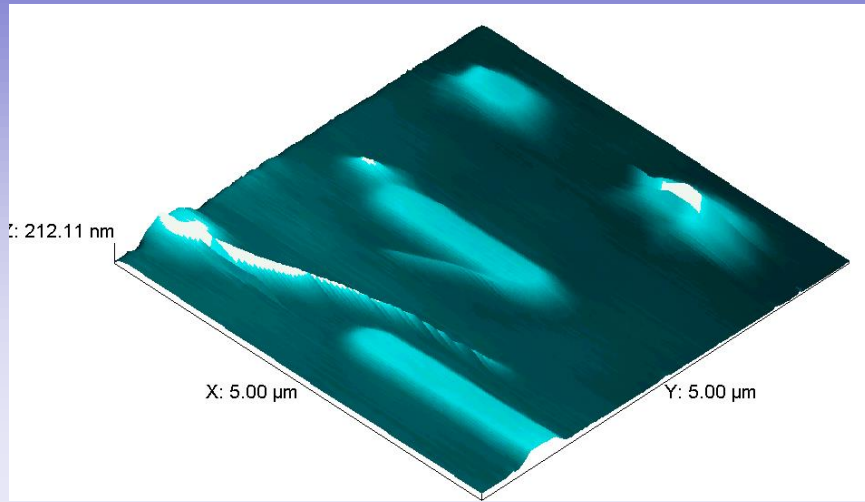

DVD

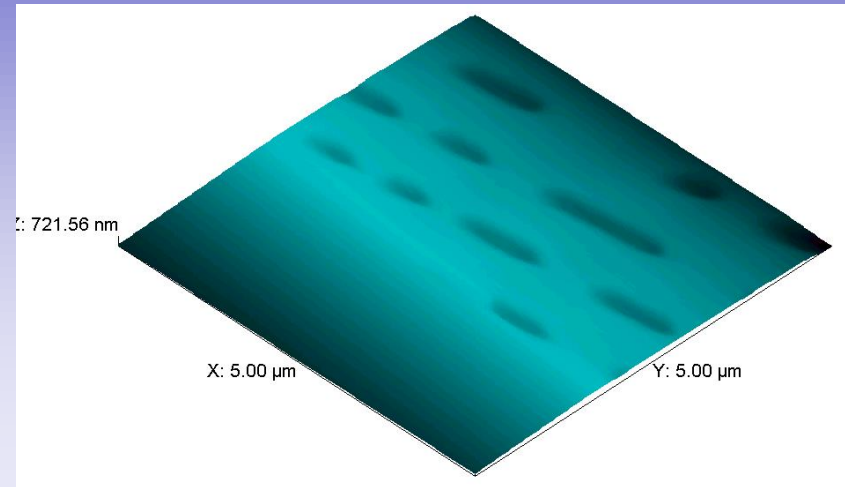

Blu-Ray

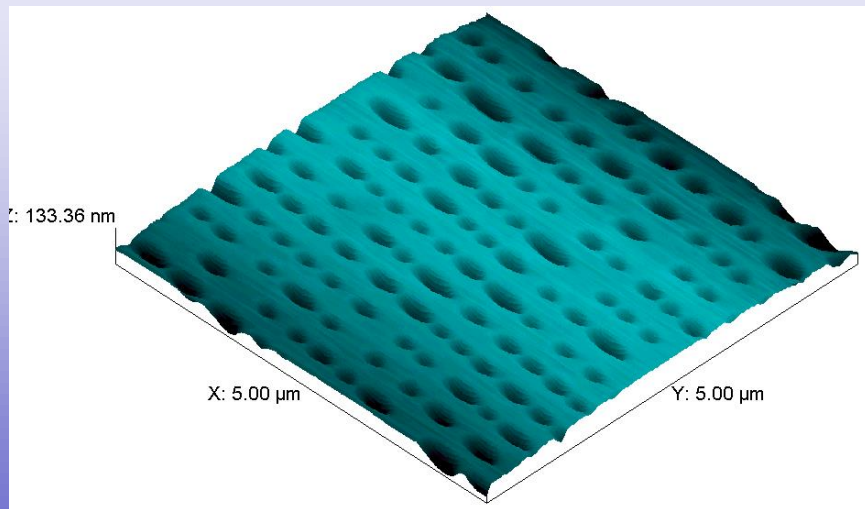

	CD	DVD	Blu-Ray
Mark length	0.99 - 2.96	0.48 - 1.45	0.14 - 0.41
Track pitch	1.63	1.00	0.40
Track width	0.50	0.24	0.15

Units in μm

$$V = C \sqrt{\left(\frac{T - T_{offset}}{T_\lambda}\right) \left(1 - \left(\frac{T - T_{offset}}{T_\lambda}\right)^{5.6}\right)}$$

Offset, intrinsic to the experiment

$$C \approx 26$$

$$T_\lambda \approx 2.17$$

$$V = C \left[\left(\frac{T - T_{offset}}{T_\lambda}\right) \left(1 - \left(\frac{T - T_{offset}}{T_\lambda}\right)^\beta\right)^\gamma \right]$$

Fit to the exponents as well

Reference where this equation came from

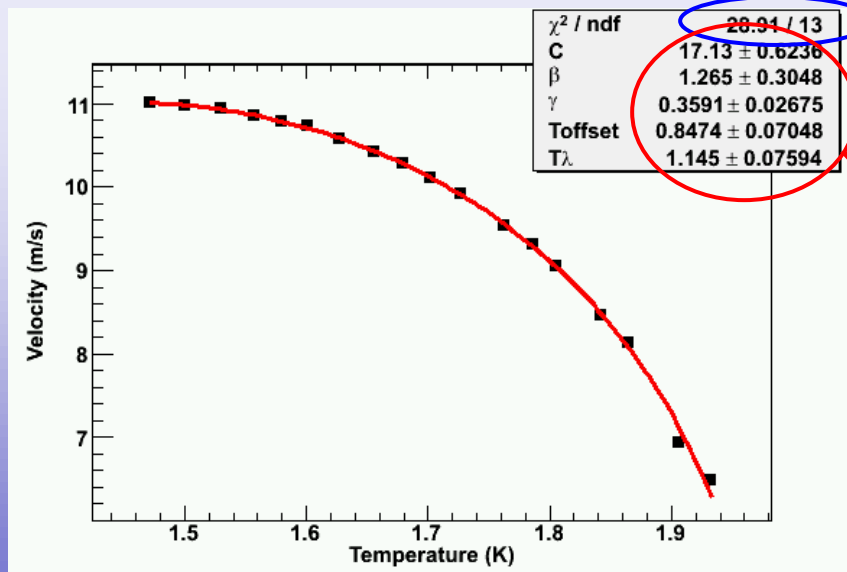

Perform the 5 parameter fit-

The values that are obtained are not very close to the expected values

Also, the fit is not the best

Try to fit the data with this function

$$V = \left(1 - \frac{T - T_{\text{offset}}}{T_{\lambda}} \right)^{\gamma}$$

The data refuses to fit to this function

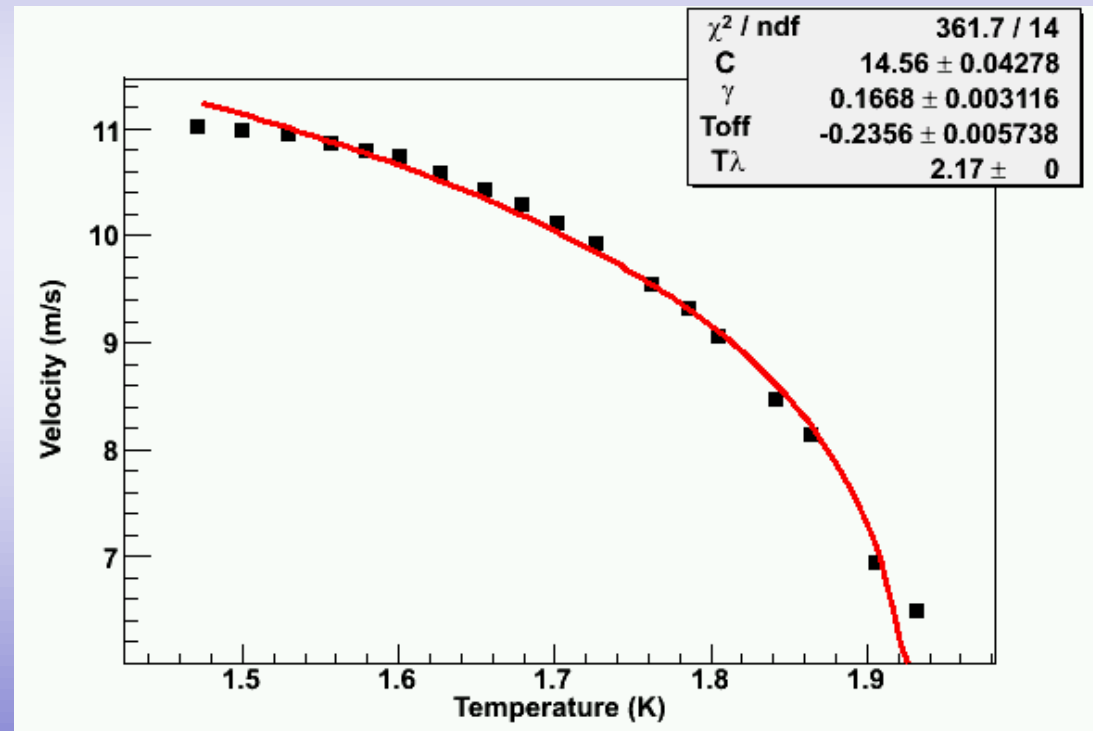

Finish your talk with discussion and conclusions and a slide showing the main points you want us to remember

- **Make sure you discuss the principal uncertainties.**
 - *For most of these experiments, it will be how accurately does your instrument measure something*
 - *A few experiments will also have statistical uncertainties ... more data leading to a better finding*
- **Include a representative (simplified) graphic**
 - *This slide will be up during question period so this graphic will get burned into people's memory*
- **Because this is a lab, offer some advice for others who follow**

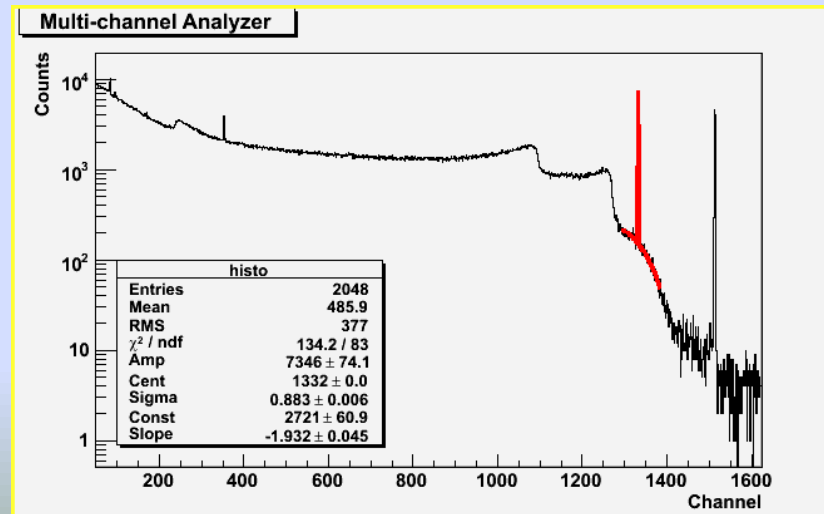

Typical Problems

Magnetic Field Calibration

- The magnetic field from the Earth and other residual magnetic fields is minimized by rotating the stand and adjusting the vertical field coils to minimize the zero field peak width.
- With the main field coils off, the sweep field is applied to determine the center of the zero field resonance (was found to be at 0.251A; using the geometry of the coils, this corresponds to 0.151 gauss).
- RF field is adjusted to provide maximum transition probability.

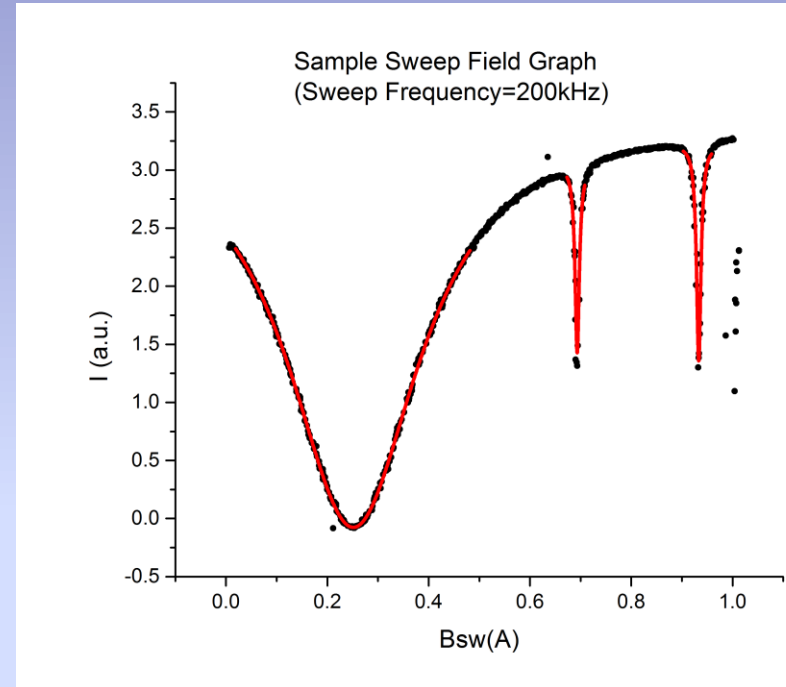

Too many words on slide

Also do not use note cards during your talk -- practice giving your talk out loud to smooth your oral delivery

Typical Problems

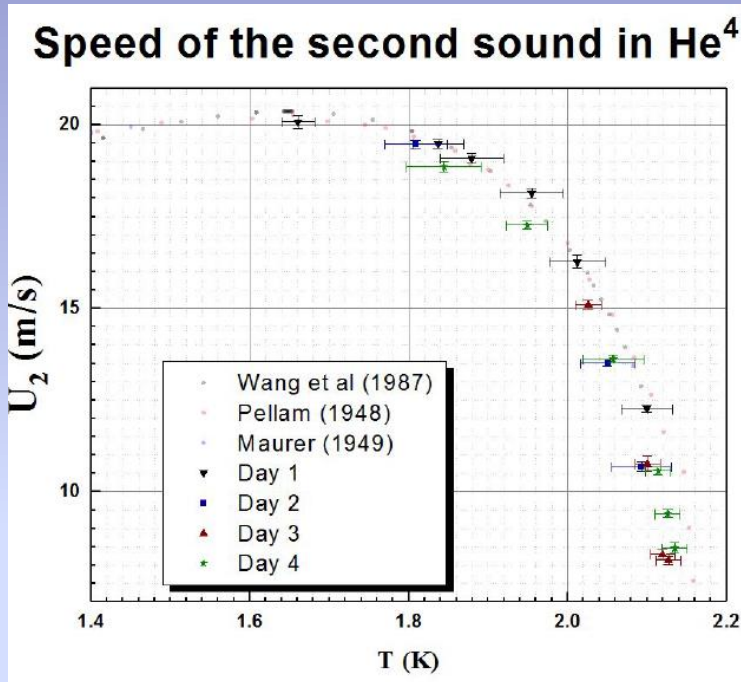

Great data but symbols are too small

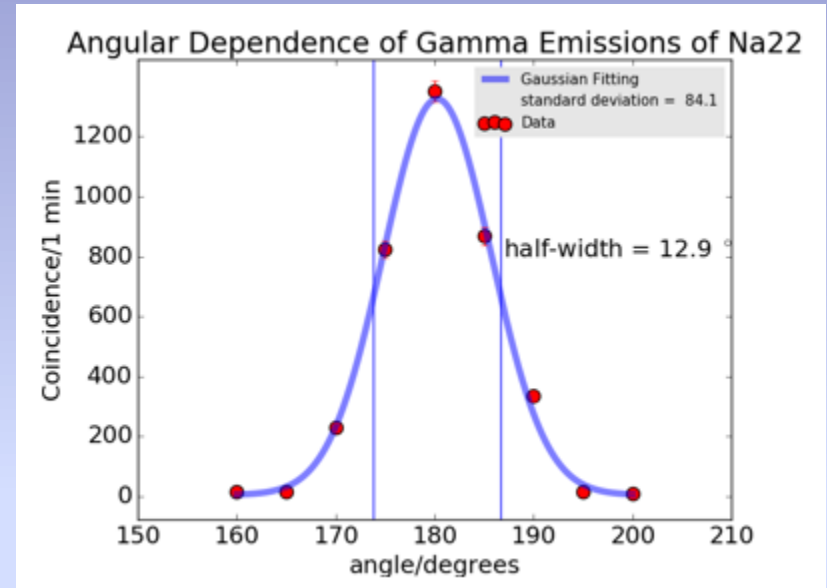

Nice figure

Typical Problems

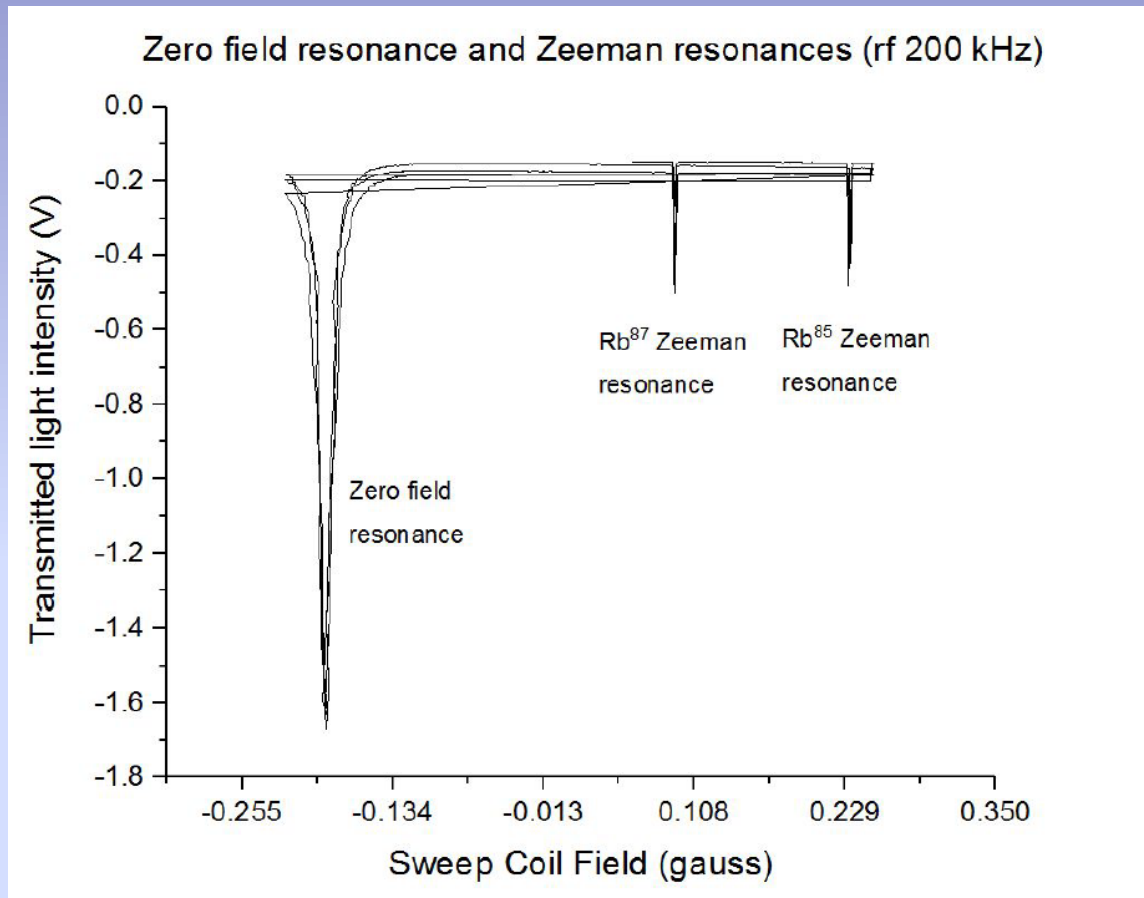

Too many lines – graph should be “polished” (Optical Pumping)

Typical Problems

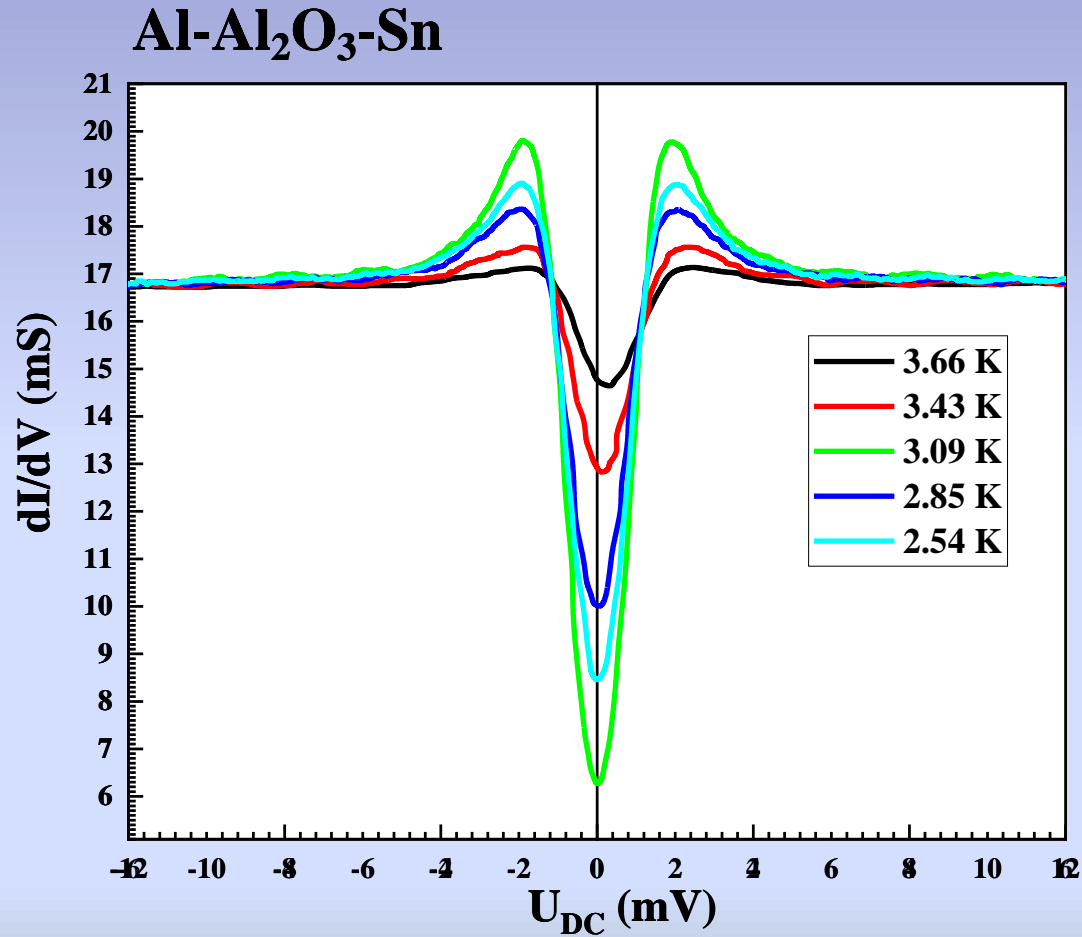

Use more contrasting colors for lines

Deadlines

- All talk **titles** should be submitted via email to Prof. Colla no later than midnight **Friday , October 11th**
- **Presentation files** should be uploaded on my.physics no later than **11:00 AM the day of your presentation**