

# NFAs continued, Closure Properties of Regular Languages

## Lecture 5

Tuesday, January 29, 2019

LaTeXed: January 29, 2019 16:22

# Regular Languages, DFAs, NFAs

## Theorem

*Languages accepted by DFAs, NFAs, and regular expressions are the same.*

DFA  $\Leftrightarrow$  NFA  $\Leftrightarrow$  Reg Exp

# Regular Languages, DFAs, NFAs

## Theorem

*Languages accepted by DFAs, NFAs, and regular expressions are the same.*

- DFAs are special cases of NFAs (trivial)
- NFAs accept regular expressions (we saw already)
- DFAs accept languages accepted by NFAs (today)
- Regular expressions for languages accepted by DFAs (later in the course)



# Part I

## Equivalence of NFAs and DFAs

# Equivalence of NFAs and DFAs

## Theorem

*For every NFA  $N$  there is a DFA  $M$  such that  $L(M) = L(N)$ .*

# Formal Tuple Notation for NFA

## Definition

A **non-deterministic finite automata (NFA)**  $N = (Q, \Sigma, \delta, s, A)$  is a five tuple where

- $Q$  is a finite set whose elements are called **states**,
- $\Sigma$  is a finite set called the **input alphabet**,
- $\delta : Q \times \Sigma \cup \{\epsilon\} \rightarrow \mathcal{P}(Q)$  is the **transition function** (here  $\mathcal{P}(Q)$  is the power set of  $Q$ ),
- $s \in Q$  is the **start state**,
- $A \subseteq Q$  is the set of **accepting/final** states.

$\delta(q, a)$  for  $a \in \Sigma \cup \{\epsilon\}$  is a subset of  $Q$  — a set of states.

# Extending the transition function to strings

## Definition

For NFA  $N = (Q, \Sigma, \delta, s, A)$  and  $q \in Q$  the  $\epsilon\text{reach}(q)$  is the set of all states that  $q$  can reach using only  $\epsilon$ -transitions.

## Definition

Inductive definition of  $\delta^* : Q \times \Sigma^* \rightarrow \mathcal{P}(Q)$ :

- if  $w = \epsilon$ ,  $\delta^*(q, w) = \epsilon\text{reach}(q)$
- if  $w = a$  where  $a \in \Sigma$   
$$\delta^*(q, a) = \cup_{p \in \epsilon\text{reach}(q)} (\cup_{r \in \delta(p, a)} \epsilon\text{reach}(r))$$
- if  $w = xa$ ,  
$$\delta^*(q, w) = \cup_{p \in \delta^*(q, x)} (\cup_{r \in \delta(p, a)} \epsilon\text{reach}(r))$$

# Formal definition of language accepted by **N**

## Definition

A string  $w$  is accepted by **NFA**  $N$  if  $\delta_N^*(s, w) \cap A \neq \emptyset$ .

## Definition

The language  $L(N)$  accepted by a **NFA**  $N = (Q, \Sigma, \delta, s, A)$  is

$$\{w \in \Sigma^* \mid \delta^*(s, w) \cap A \neq \emptyset\}.$$



# Simulating an NFA by a DFA

- Think of a program with fixed memory that needs to simulate NFA  $N$  on input  $w$ .
- What does it need to store after seeing a prefix  $x$  of  $w$ ?

# Simulating an NFA by a DFA

- Think of a program with fixed memory that needs to simulate NFA  $N$  on input  $w$ .
- What does it need to store after seeing a prefix  $x$  of  $w$ ?
- It needs to know at least  $\delta^*(s, x)$ , the set of states that  $N$  could be in after reading  $x$
- Is it sufficient?

# Simulating an NFA by a DFA

- Think of a program with fixed memory that needs to simulate NFA  $N$  on input  $w$ .
- What does it need to store after seeing a prefix  $x$  of  $w$ ?
- It needs to know at least  $\delta^*(s, x)$ , the set of states that  $N$  could be in after reading  $x$
- Is it sufficient? Yes, if it can compute  $\delta^*(s, xa)$  after seeing another symbol  $a$  in the input.
- When should the program accept a string  $w$ ?

# Simulating an NFA by a DFA

- Think of a program with fixed memory that needs to simulate NFA  $N$  on input  $w$ .
- What does it need to store after seeing a prefix  $x$  of  $w$ ?
- It needs to know at least  $\delta^*(s, x)$ , the set of states that  $N$  could be in after reading  $x$
- Is it sufficient? Yes, if it can compute  $\delta^*(s, xa)$  after seeing another symbol  $a$  in the input.
- When should the program accept a string  $w$ ? If  $\delta^*(s, w) \cap A \neq \emptyset$ .

**Key Observation:** A DFA  $M$  that simulates  $N$  should keep in its memory/state the **set of states of  $N$**

Thus the state space of the DFA should be  $\mathcal{P}(Q)$ .

# Subset Construction

**NFA**  $N = (Q, \Sigma, s, \delta, A)$ . We create a **DFA**  $M = (Q', \Sigma, \delta', s', A')$  as follows:

- $Q' = \mathcal{P}(Q)$

# Subset Construction

**NFA**  $N = (Q, \Sigma, s, \delta, A)$ . We create a **DFA**  $M = (Q', \Sigma, \delta', s', A')$  as follows:

- $Q' = \mathcal{P}(Q)$
- $s' = \epsilon\text{reach}(s) = \delta^*(s, \epsilon)$

# Subset Construction

**NFA**  $N = (Q, \Sigma, s, \delta, A)$ . We create a **DFA**  $M = (Q', \Sigma, \delta', s', A')$  as follows:

- $Q' = \mathcal{P}(Q)$
- $s' = \epsilon\text{reach}(s) = \delta^*(s, \epsilon)$
- $A' = \{X \subseteq Q \mid X \cap A \neq \emptyset\}$

# Subset Construction

**NFA**  $N = (Q, \Sigma, s, \delta, A)$ . We create a **DFA**  $M = (Q', \Sigma, \delta', s', A')$  as follows:

- $Q' = \mathcal{P}(Q)$
- $s' = \epsilon\text{reach}(s) = \delta^*(s, \epsilon)$
- $A' = \{X \subseteq Q \mid X \cap A \neq \emptyset\}$
- $\delta'(X, a) = \cup_{q \in X} \delta^*(q, a)$  for each  $X \subseteq Q, a \in \Sigma$ .



# Example

No  $\epsilon$ -transitions

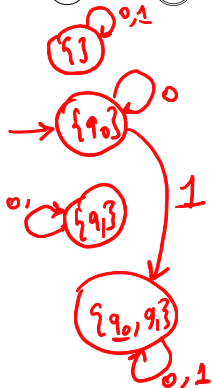
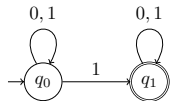

# Example

No  $\epsilon$ -transitions

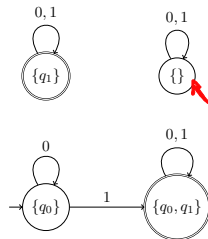
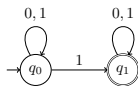

# Simulating NFA

Example the first revisited

Previous lecture.. Ran

NFA<sup>(N1)</sup>

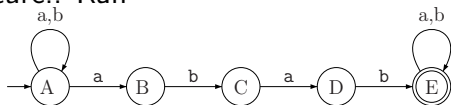

on input *ababa*.

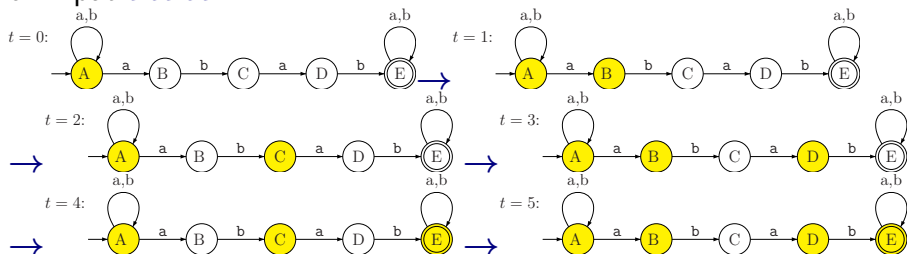

# Example: DFA from NFA

**NFA:** (N1)  
**DFA:**

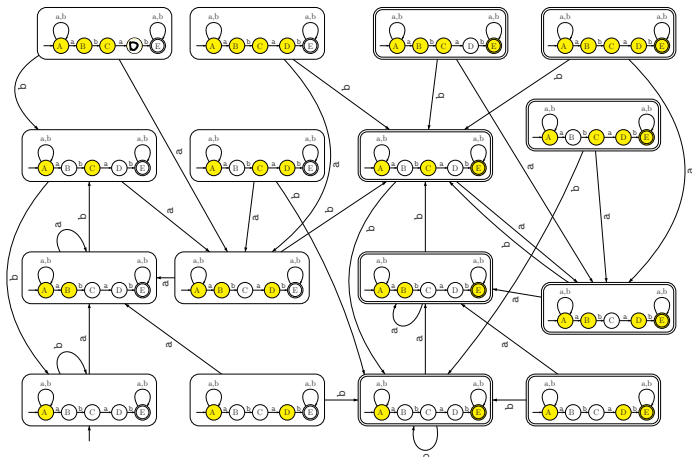
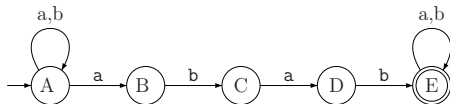

# Incremental construction

Only build states reachable from  $s' = \epsilon\text{reach}(s)$  the start state of  $M$

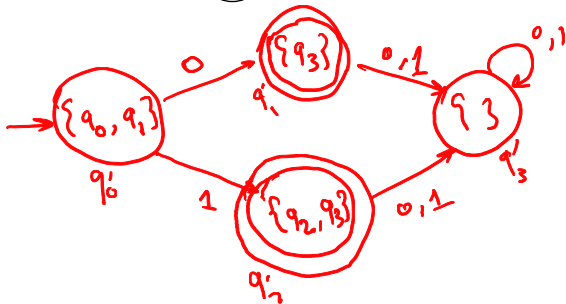
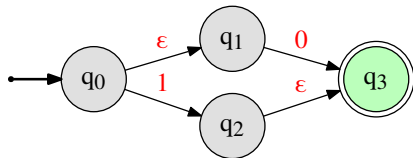

# Incremental construction

Only build states reachable from  $s' = \epsilon\text{reach}(s)$  the start state of  $M$

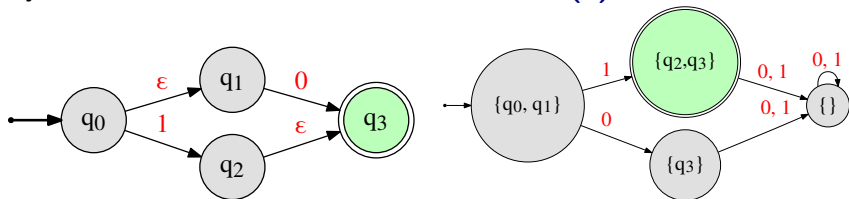

$$\delta'(X, a) = \cup_{q \in X} \delta^*(q, a)$$

# Incremental algorithm

- Build  $M$  beginning with start state  $s' == \epsilon\text{reach}(s)$
- For each existing state  $X \subseteq Q$  consider each  $a \in \Sigma$  and calculate the state  $Y = \delta'(X, a) = \cup_{q \in X} \delta^*(q, a)$  and add a transition.
- If  $Y$  is a new state add it to reachable states that need to be explored.

To compute  $\delta^*(q, a)$  - set of all states reached from  $q$  on *string*  $a$

- Compute  $X = \epsilon\text{reach}(q)$
- Compute  $Y = \cup_{p \in X} \delta(p, a)$
- Compute  $Z = \epsilon\text{reach}(Y) = \cup_{r \in Y} \epsilon\text{reach}(r)$

# Proof of Correctness

## Theorem

Let  $N = (Q, \Sigma, s, \delta, A)$  be a **NFA** and let  $M = (Q', \Sigma, \delta', s', A')$  be a **DFA** constructed from  $N$  via the subset construction. Then  $L(N) = L(M)$ .



# Proof of Correctness

## Theorem

Let  $N = (Q, \Sigma, s, \delta, A)$  be a **NFA** and let  $M = (Q', \Sigma, \delta', s', A')$  be a **DFA** constructed from  $N$  via the subset construction. Then  $L(N) = L(M)$ .

Stronger claim:

## Lemma

For every string  $w$ ,  $\delta_N^*(s, w) = \delta_M^*(s', w)$ .

Proof by induction on  $|w|$ .

**Base case:**  $w = \epsilon$ .

$$\delta_N^*(s, \epsilon) = \epsilon\text{reach}(s).$$

$$\delta_M^*(s', \epsilon) = s' = \epsilon\text{reach}(s) \text{ by definition of } s'.$$

# Proof continued

## Lemma

For every string  $w$ ,  $\delta_N^*(s, w) = \delta_M^*(s', w)$ .

**Inductive step:**  $w = xa$  (Note: suffix definition of strings)  
 $\delta_N^*(s, xa) = \cup_{p \in \delta_N^*(s, x)} \delta_N^*(p, a)$  by inductive definition of  $\delta_N^*$

# Proof continued

## Lemma

For every string  $w$ ,  $\delta_N^*(s, w) = \delta_M^*(s', w)$ .

**Inductive step:**  $w = xa$  (Note: suffix definition of strings)

$\delta_N^*(s, xa) = \cup_{p \in \delta_N^*(s, x)} \delta_N^*(p, a)$  by inductive definition of  $\delta_N^*$

$\delta_M^*(s', xa) = \delta_M(\delta_M^*(s, x), a)$  by inductive definition of  $\delta_M^*$

# Proof continued

## Lemma

For every string  $w$ ,  $\delta_N^*(s, w) = \delta_M^*(s', w)$ .

**Inductive step:**  $w = xa$  (Note: suffix definition of strings)

$\delta_N^*(s, xa) = \cup_{p \in \delta_N^*(s, x)} \delta_N^*(p, a)$  by inductive definition of  $\delta_N^*$

$\delta_M^*(s', xa) = \delta_M^*(\delta_M^*(s, x), a)$  by inductive definition of  $\delta_M^*$

By inductive hypothesis:  $Y = \delta_N^*(s, x) = \delta_M^*(s, x)$

# Proof continued

## Lemma

For every string  $w$ ,  $\delta_N^*(s, w) = \delta_M^*(s', w)$ .

**Inductive step:**  $w = xa$  (Note: suffix definition of strings)

$\delta_N^*(s, xa) = \cup_{p \in \delta_N^*(s, x)} \delta_N^*(p, a)$  by inductive definition of  $\delta_N^*$

$\delta_M^*(s', xa) = \delta_M^*(\delta_M^*(s, x), a)$  by inductive definition of  $\delta_M^*$

By inductive hypothesis:  $Y = \delta_N^*(s, x) = \delta_M^*(s, x)$

Thus  $\delta_N^*(s, xa) = \cup_{p \in Y} \delta_N^*(p, a) = \delta_M^*(Y, a)$  by definition of  $\delta_M^*$ .

## Lemma

For every string  $w$ ,  $\delta_N^*(s, w) = \delta_M^*(s', w)$ .

**Inductive step:**  $w = xa$  (Note: suffix definition of strings)

$\delta_N^*(s, xa) = \cup_{p \in \delta_N^*(s, x)} \delta_N^*(p, a)$  by inductive definition of  $\delta_N^*$

$\delta_M^*(s', xa) = \delta_M^*(\delta_M^*(s, x), a)$  by inductive definition of  $\delta_M^*$

By inductive hypothesis:  $Y = \delta_N^*(s, x) = \delta_M^*(s, x)$

Thus  $\delta_N^*(s, xa) = \cup_{p \in Y} \delta_N^*(p, a) = \delta_M^*(Y, a)$  by definition of  $\delta_M^*$ .

Therefore,

$\delta_N^*(s, xa) = \delta_M^*(Y, a) = \delta_M^*(\delta_M^*(s, x), a) = \delta_M^*(s', xa)$

which is what we need.

# Example: DFA from NFA

NFA: (N1)

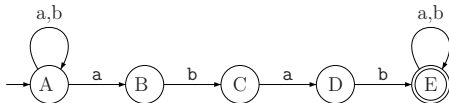

DFA:

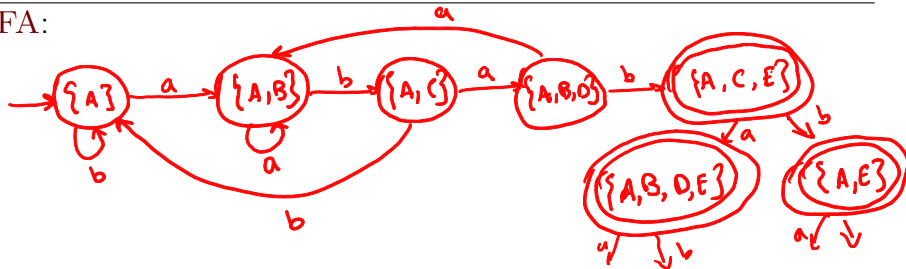

## Part II

# Closure Properties of Regular Languages



# Regular Languages

Regular languages have three different characterizations

- Inductive definition via base cases and closure under union, concatenation and Kleene star
- Languages accepted by **DFA**s
- Languages accepted by **NFA**s

# Regular Languages

Regular languages have three different characterizations

- Inductive definition via base cases and closure under union, concatenation and Kleene star
- Languages accepted by **DFA**s
- Languages accepted by **NFA**s

Regular language closed under many operations:

- union, concatenation, Kleene star via inductive definition or **NFA**s
- complement, union, intersection via **DFA**s
- homomorphism, inverse homomorphism, reverse, . . .

Different representations allow for flexibility in proofs

# Examples: PREFIX and SUFFIX

Let  $L$  be a language over  $\Sigma$ .

## Definition

$$\text{PREFIX}(L) = \{w \mid wx \in L, x \in \Sigma^*\}$$

## Definition

$$\text{SUFFIX}(L) = \{w \mid xw \in L, x \in \Sigma^*\}$$

# Examples: PREFIX and SUFFIX

Let  $L$  be a language over  $\Sigma$ .

## Definition

$$\text{PREFIX}(L) = \{w \mid wx \in L, x \in \Sigma^*\}$$

## Definition

$$\text{SUFFIX}(L) = \{w \mid xw \in L, x \in \Sigma^*\}$$

## Theorem

*If  $L$  is regular then  $\text{PREFIX}(L)$  is regular.*

## Theorem

*If  $L$  is regular then  $\text{SUFFIX}(L)$  is regular.*

# PREFIX

Let  $M = (Q, \Sigma, \delta, s, A)$  be a DFA that recognizes  $L$

Create new DFA/NFA to accept  $\text{PREFIX}(L)$  (or  $\text{SUFFIX}(L)$ ).

# PREFIX

Let  $M = (Q, \Sigma, \delta, s, A)$  be a DFA that recognizes  $L$

Create new DFA/NFA to accept  $\text{PREFIX}(L)$  (or  $\text{SUFFIX}(L)$ ).

$$X = \{q \in Q \mid s \text{ can reach } q \text{ in } M\}$$

$$Y = \{q \in Q \mid q \text{ can reach some state in } A\}$$

$$Z = X \cap Y$$

## Theorem

Consider DFA  $M' = (Q, \Sigma, \delta, s, Z)$ .  $L(M') = \text{PREFIX}(L)$ .

# SUFFIX

Let  $M = (Q, \Sigma, \delta, s, A)$  be a DFA that recognizes  $L$

# SUFFIX

Let  $M = (Q, \Sigma, \delta, s, A)$  be a DFA that recognizes  $L$

$$X = \{q \in Q \mid s \text{ can reach } q \text{ in } M\}$$



# SUFFIX

Let  $M = (Q, \Sigma, \delta, s, A)$  be a DFA that recognizes  $L$

$$X = \{q \in Q \mid s \text{ can reach } q \text{ in } M\}$$

Consider NFA  $N = (Q \cup \{s'\}, \Sigma, \delta', s', A)$ . Add new start state  $s'$  and  $\epsilon$ -transition from  $s'$  to each state in  $X$ .

# SUFFIX

Let  $M = (Q, \Sigma, \delta, s, A)$  be a DFA that recognizes  $L$

$$X = \{q \in Q \mid s \text{ can reach } q \text{ in } M\}$$

Consider NFA  $N = (Q \cup \{s'\}, \Sigma, \delta', s', A)$ . Add new start state  $s'$  and  $\epsilon$ -transition from  $s'$  to each state in  $X$ .

**Claim:**  $L(N) = \text{SUFFIX}(L)$ .

## Part III

# DFA to Regular Expressions

# DFA to Regular Expressions

## Theorem

*Given a DFA  $M = (Q, \Sigma, \delta, s, A)$  there is a regular expression  $r$  such that  $L(r) = L(M)$ . That is, regular expressions are as powerful as DFAs (and hence also NFAs).*

- Simple algorithm but formal proof is involved. See notes.
- An easier proof via a more involved algorithm later in course.

# Stage 0: Input

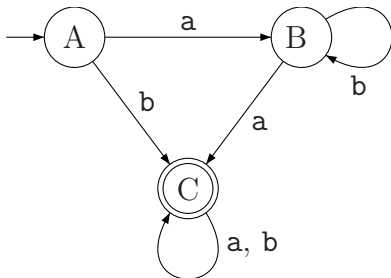

# Stage 1: Normalizing

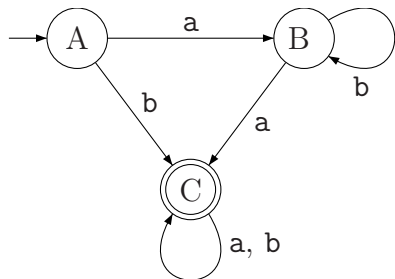

2: Normalizing it.

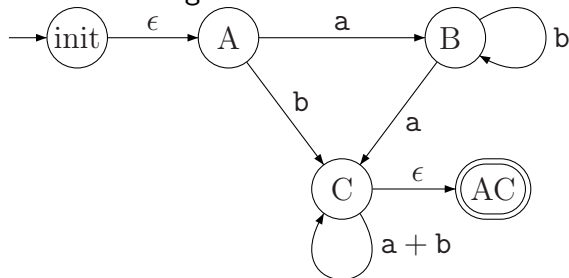

## Stage 2: Remove state A

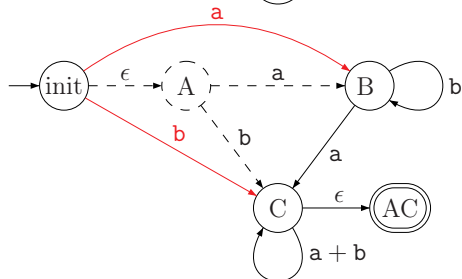
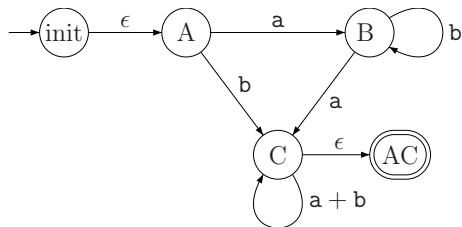

## Stage 4: Redrawn without old edges

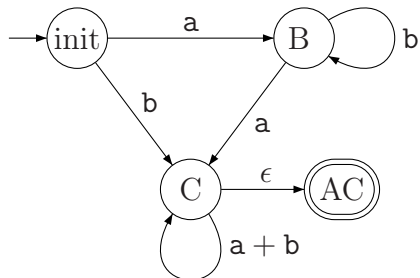

$b + ab^*a$



# Stage 4: Removing B

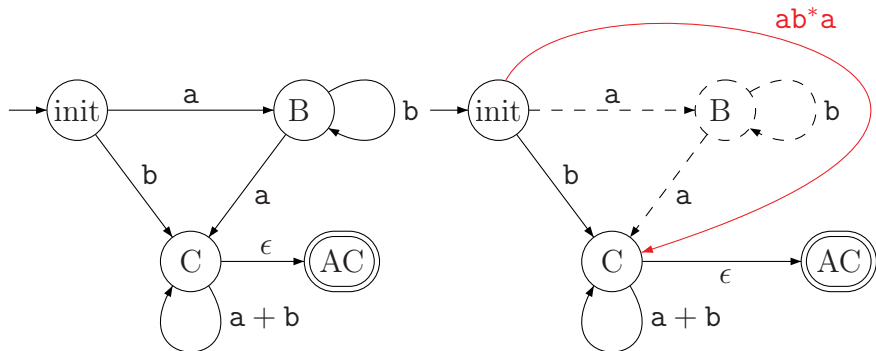

# Stage 5: Redraw

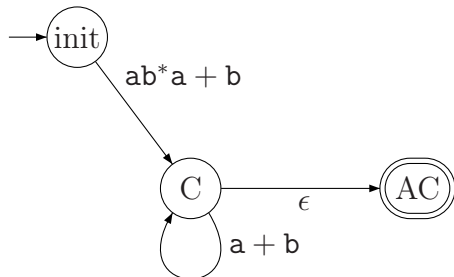

# Stage 6: Removing C

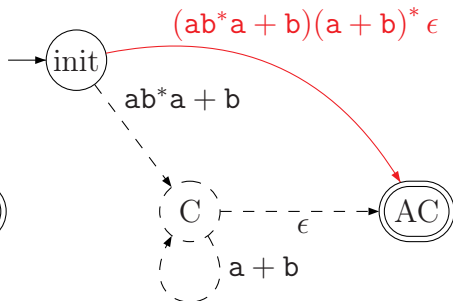
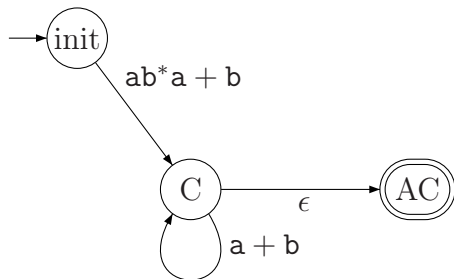

# Stage 7: Redraw

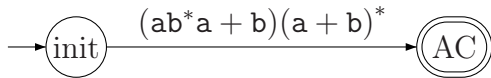

## Stage 8: Extract regular expression

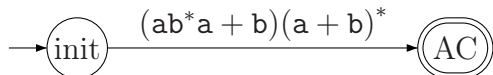

Thus, this automata is equivalent to the regular expression  $(ab^*a + b)(a + b)^*$ .