

“All of modern physics is governed by that magnificent and thoroughly confusing discipline called quantum mechanics...It has survived all tests and there is no reason to believe that there is any flaw in it....We all know how to use it and how to apply it to problems; and so we have learned to live with the fact that nobody can understand it.”

--Murray Gell-Mann

Lecture 11:

Particles in Finite Potential Wells

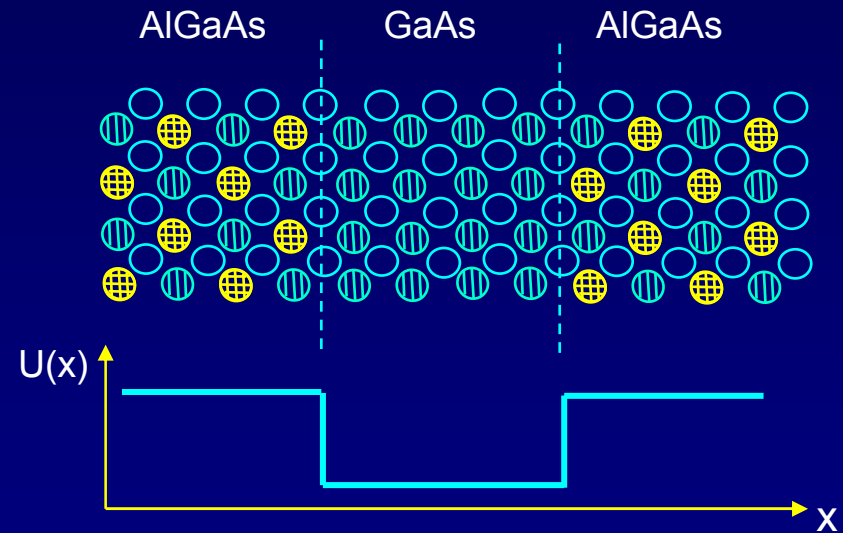
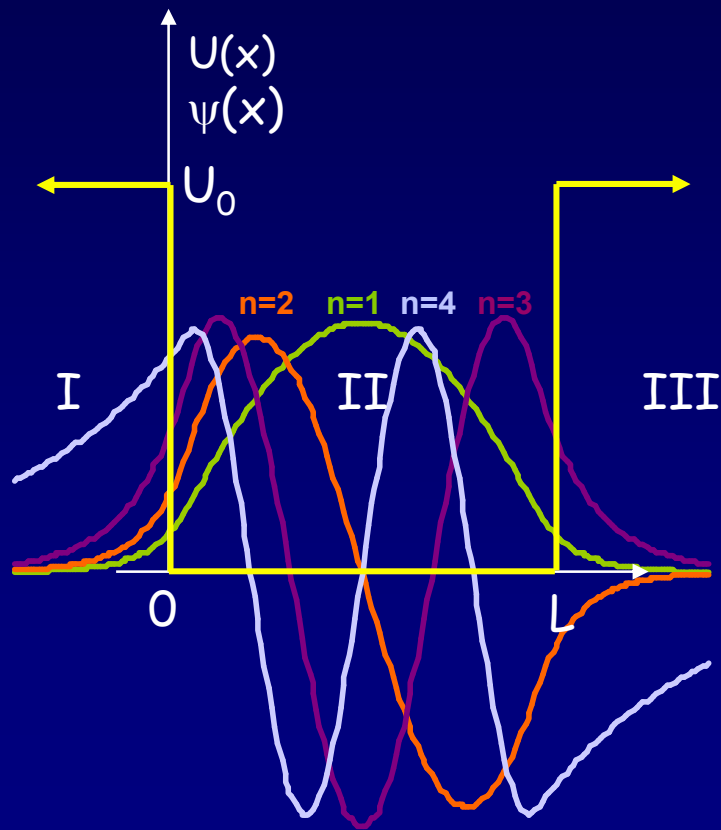

This week and last week are critical for the course:

Week 3, Lectures 7-9:

Light as Particles
Particles as waves
Probability
Uncertainty Principle

Week 4, Lectures 10-12:

Schrödinger Equation
Particles in infinite wells, finite wells

Midterm Exam Monday, week 5

It will cover lectures 1-11 and some aspects of lecture 12 (not SHOs).

Practice exams: Old exams are linked from the course web page.

Review: Sunday before Midterm

Office hours: Sunday and Monday

Next week:

Homework 4 covers material in lecture 10 – due on Thur. after midterm.

We strongly encourage you to **look at the homework before the midterm!**

Discussion: Covers material in lectures 10-12. There will be a **quiz**.

Lab: **Go to 257 Loomis** (a computer room).

You can save a lot of time by reading the lab ahead of time –

It's a tutorial on how to draw wave functions.

Last Time

Schrodinger's Equation (SEQ)

A wave equation that describes spatial and time dependence of $\Psi(x,t)$.
Expresses $KE + PE = E_{\text{tot}}$
Second derivative extracts $-k^2$ from wave function.

Constraints that $\psi(x)$ must satisfy

Existence of derivatives (implies continuity).
Boundary conditions at interfaces.

Infinitely deep 1D square well ("box")

Boundary conditions $\rightarrow \psi(x) = N\sin(kx)$, where $k = n\pi/L$.
Discrete energy spectrum: $E_n = n^2E_1$, where $E_1 = h^2/8mL^2$.

Today

“Normalizing” the wave function

General properties of bound-state wave functions

Particle in a finite square well potential

Solving boundary conditions

Comparison with infinite-well potential

Particle in Infinite Square Well Potential

$$\psi_n(x) \propto \sin(k_n x) = \sin\left(\frac{2\pi}{\lambda_n} x\right) = \sin\left(\frac{n\pi}{L} x\right) \quad \text{for } 0 \leq x \leq L$$

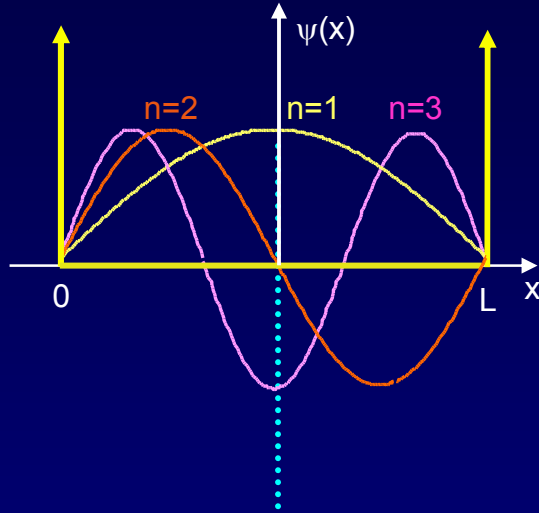

$$n\lambda_n = 2L$$

~~$$-\frac{\hbar^2}{2m} \frac{d^2 \psi_n(x)}{dx^2} + U(x)\psi_n(x) = E_n \psi_n(x)$$~~

The discrete E_n are known as “energy eigenvalues”:

$$E_n = \frac{p^2}{2m} = \frac{h^2}{2m\lambda_n^2} = \frac{1.505 \text{ eV} \cdot \text{nm}^2}{\lambda_n^2}$$

$$E_n = E_1 n^2 \quad \text{where} \quad E_1 \equiv \frac{h^2}{8mL^2}$$

electron

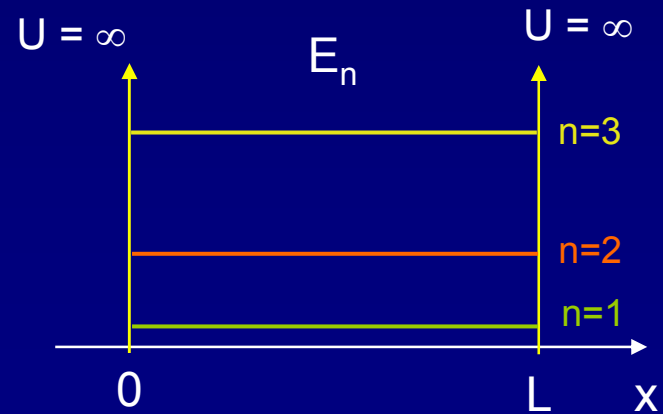

Constraints on the Form of $\psi(x)$

$|\psi(x)|^2$ corresponds to a physically meaningful quantity:
the **probability density** of finding the particle near x .

To avoid unphysical behavior, $\psi(x)$ must satisfy some conditions:

$\psi(x)$ must be single-valued, and finite.

Finite to avoid infinite probability density.

$\psi(x)$ must be continuous, with finite $d\psi/dx$.

$d\psi/dx$ is related to the momentum.

In regions with finite potential, $d^2\psi/dx^2$ must be finite.

To avoid infinite energies.

This also means that $d\psi/dx$ must be continuous.

There is no significance to the overall *sign* of $\psi(x)$.

It goes away when we take the absolute square.

{In fact, we will see that $\psi(x,t)$ is usually complex!}

Act 1

1. Which of the following wave functions corresponds to a particle more likely to be found on the left side?

(a)

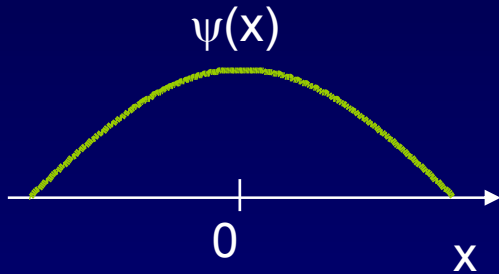

(b)

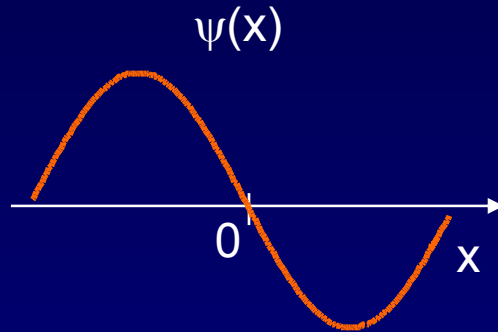

(c)

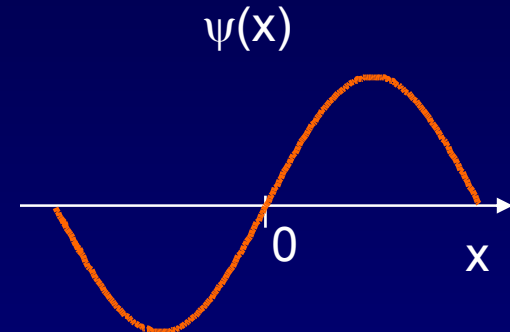

Solution

1. Which of the following wave functions corresponds to a particle more likely to be found on the left side?

(a)

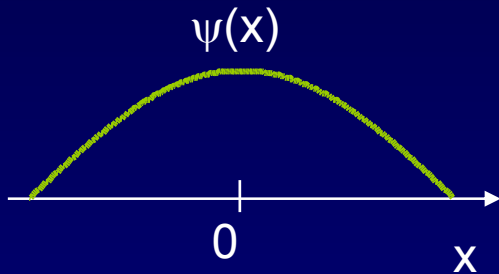

(b)

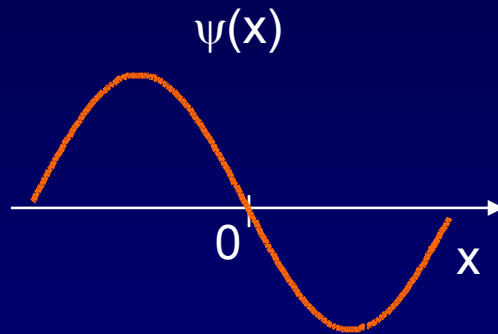

(c)

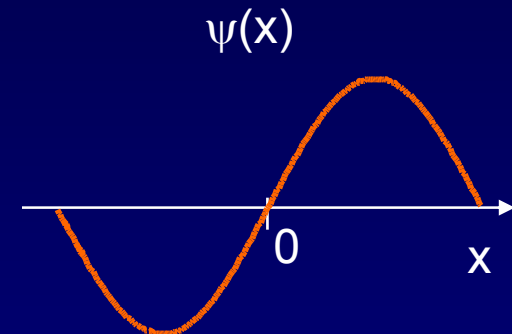

None of them!

(a) is clearly symmetrical.

(b) might seem to be “higher” on the left than on the right, but only the absolute square determines the probability.

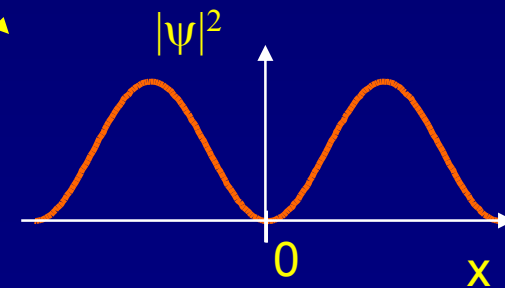

Originally published under the title, "Zur Quantenmechanik der Stössvorgänge," *Zeitschrift für Physik*, 37, 863–67 (1926); reprinted in *Dokumente der Naturwissenschaft*, 1, 48–52 (1962) and in M. Born (1963); translation into English by J.A.W. and W.H.Z., 1981.

I.2 ON THE QUANTUM MECHANICS OF COLLISIONS

[Preliminary communication][†]

MAX BORN

Through the investigation of collisions it is argued that quantum mechanics in the Schrödinger form allows one to describe not only stationary states but also quantum jumps.

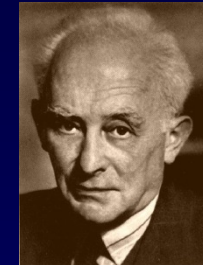

If one translates this result into terms of particles, only one interpretation is possible. $\Phi_{n,m}(\alpha, \beta, \gamma)$ gives the probability* for the electron, arriving from the z -direction, to be thrown out into the direction designated by the angles α, β, γ , with the phase change δ . Here its energy τ has increased by one quantum $h\nu_{nm}^0$ at the

* Addition in proof: More careful consideration shows that the probability is proportional to the square of the quantity $\Phi_{n,m}$.

“Again an idea of Einstein’s gave me the lead. He had tried to make the duality of particles – light quanta or photons - and waves comprehensible by interpreting the square of the optical wave amplitudes as probability density for the occurrence of photons. This concept could at once be carried over to the Ψ -function: $|\Psi|^2$ ought to represent the probability density for electrons (or other particles). It was easy to assert this, but how could it be proved?”

M. Born, Nobel Lecture (1954).

Probabilities

Often what we measure in an experiment is the probability density, $|\psi(x)|^2$.

$$\psi_n(x) = B_1 \sin\left(\frac{n\pi}{L}x\right) \quad \begin{array}{l} \text{Wavefunction =} \\ \text{Probability amplitude} \end{array}$$

$$|\psi_n(x)|^2 = B_1^2 \sin^2\left(\frac{n\pi}{L}x\right) \quad \begin{array}{l} \text{Probability per} \\ \text{unit length} \\ \text{(in 1-dimension)} \end{array}$$

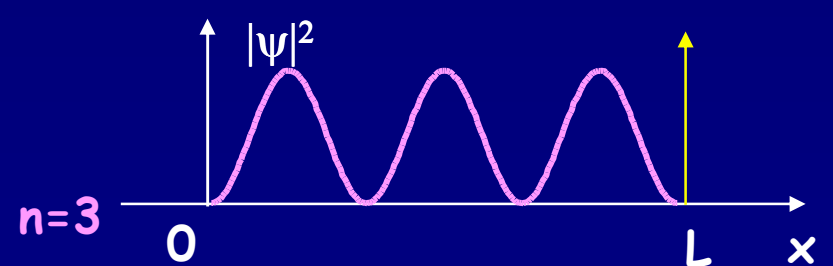
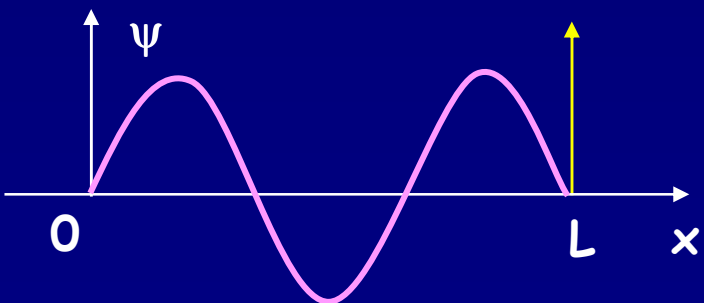
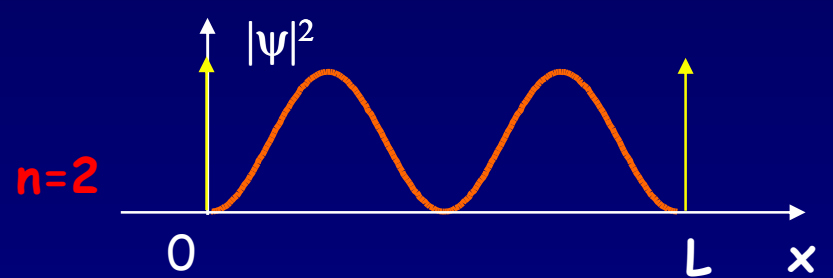
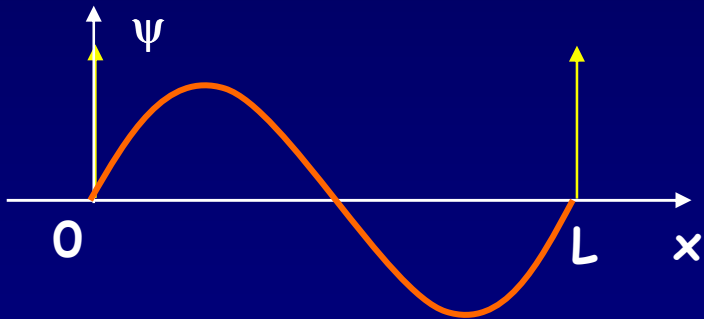
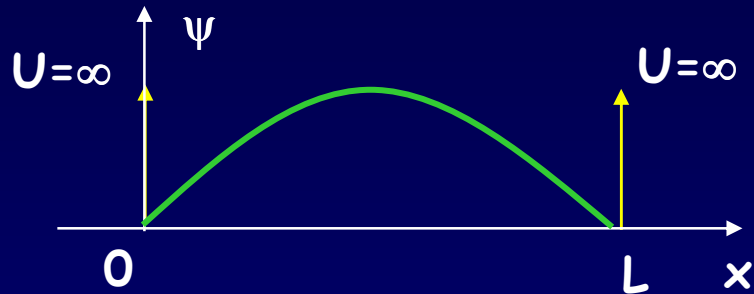

Probability and Normalization

We now know that $\psi_n(x) = B_1 \sin\left(\frac{n\pi}{L}x\right)$. How can we determine B_1 ?

We need another constraint. It is the requirement that **total probability equals 1**.

The probability density at x is $|\psi(x)|^2$:

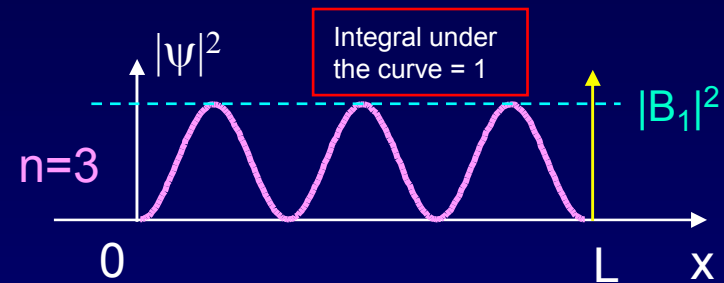

Therefore, the total probability is the integral:

$$P_{tot} = \int_{-\infty}^{\infty} |\psi(x)|^2 dx$$

In our square well problem, the integral is simpler, because $\psi = 0$ for $x < 0$ and $x > L$:

$$\begin{aligned} P_{tot} &= |B_1|^2 \int_0^L \left| \sin\left(\frac{n\pi}{L}x\right) \right|^2 dx \\ &= |B_1|^2 \frac{L}{2} \end{aligned}$$

Requiring that $P_{tot} = 1$ gives us:

$$B_1 = \sqrt{\frac{2}{L}}$$

Probability Density

In the infinite well: $P(x) = N^2 \sin^2\left(\frac{n\pi}{L}x\right)$. (Units are m^{-1} , in 1D)

Notation: The constant is typically written as “N”, and is called the “**normalization constant**”. For the square well:

$$N = \sqrt{\frac{2}{L}}$$

One important difference with the classical result:

For a classical particle bouncing back and forth in a well, the probability of finding the particle is equally likely throughout the well.

For a quantum particle in a stationary state, the probability distribution is not uniform. There are “nodes” where the probability is zero!

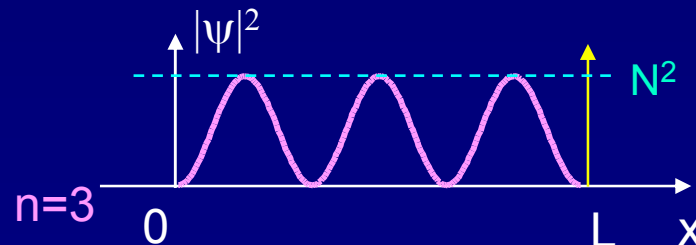

Particle in a Finite Well (1)

What if the walls of our “box” aren’t infinitely high?

We will consider finite U_0 , with $E < U_0$, so the particle is still trapped.

This situation introduces the very important concept of “barrier penetration”.

As before, solve the SEQ in the three regions.

Region II:

$U = 0$, so the solution is the same as before:

$$\psi_{II}(x) = B_1 \sin kx + B_2 \cos kx$$

We do not impose the infinite well boundary conditions, because they are not the same here. We will find that B_2 is no longer zero.

Before we consider boundary conditions, we must first determine the solutions in regions I and III.

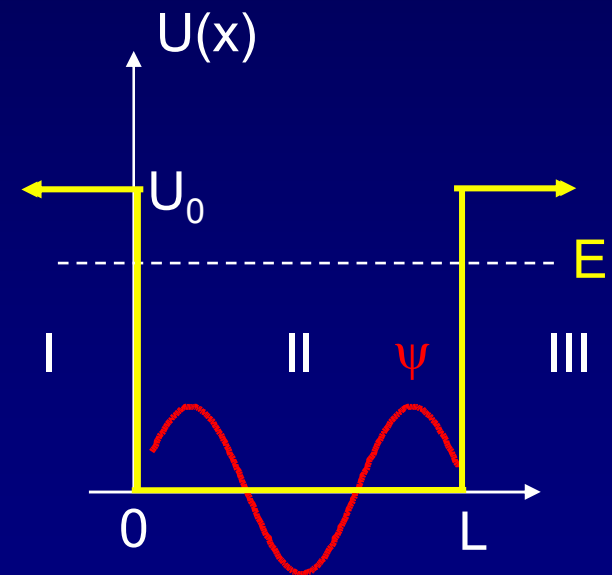

Particle in a Finite Well (2)

Regions I and III:
 $U(x) = U_0$, and $E < U_0$

Because $E < U_0$, these regions are "forbidden" in classical particles.

The SEQ $\frac{d^2 \psi(x)}{dx^2} + \frac{2m}{\hbar^2}(E - U)\psi(x) = 0$ can be written:

$$\frac{d^2 \psi(x)}{dx^2} - K^2 \psi(x) = 0$$

In region II this was a + sign.

where: $K = \sqrt{\frac{2m}{\hbar^2}(U_0 - E)}$

$U_0 > E$:
 K is real.

The general solution to this equation is:

Region I: $\psi_I(x) = C_1 e^{Kx} + C_2 e^{-Kx}$

Region III: $\psi_{III}(x) = D_1 e^{Kx} + D_2 e^{-Kx}$

C_1 , C_2 , D_1 , and D_2 , will be determined by the boundary conditions.

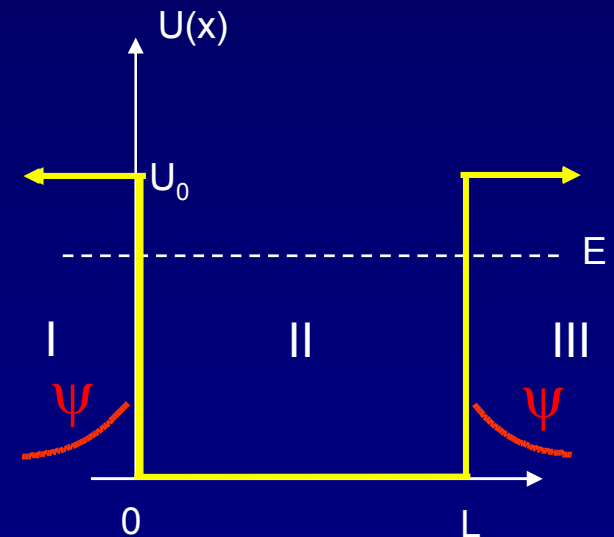

Particle in a Finite Well (3)

Important new result! (worth putting on its own slide)

For quantum entities, there is a finite probability amplitude, ψ , to find the particle inside a “classically-forbidden” region, *i.e.*, inside a barrier.

$$\psi_I(x) = C_1 e^{Kx} + C_2 e^{-Kx}$$

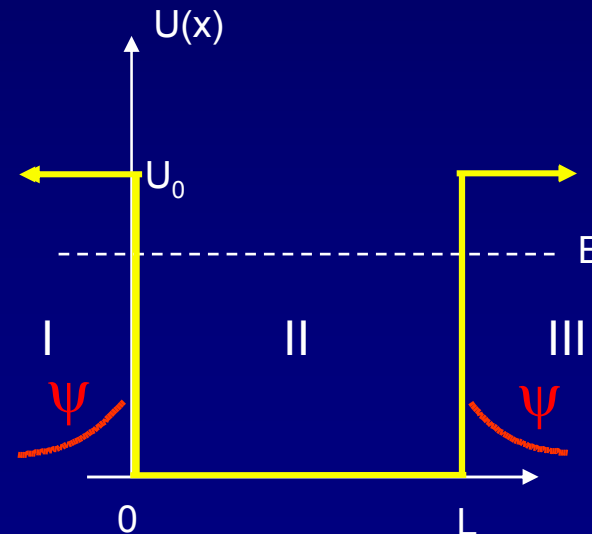

ACT 2

In region III, the wave function has the form

$$\psi_{III}(x) = D_1 e^{Kx} + D_2 e^{-Kx}$$

1. As $x \rightarrow \infty$, the wave function must vanish.
(why?) What does this imply for D_1 and D_2 ?

a. $D_1 = 0$ b. $D_2 = 0$ c. D_1 and D_2 are both nonzero.

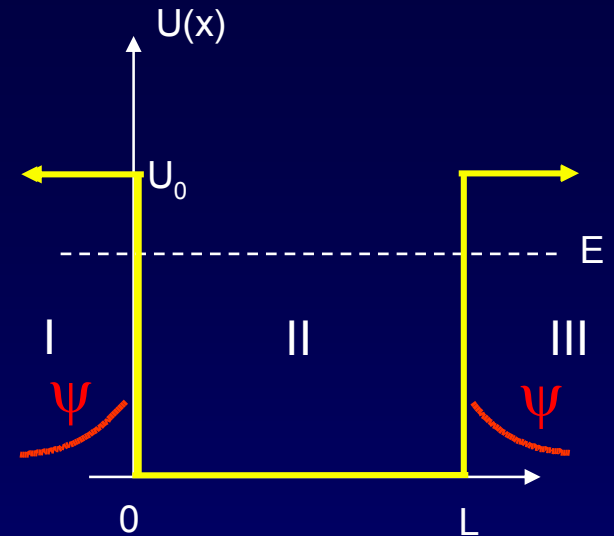

2. What can we say about the coefficients C_1 and C_2 for the wave function in region I?

$$\psi_I(x) = C_1 e^{Kx} + C_2 e^{-Kx}$$

a. $C_1 = 0$ b. $C_2 = 0$ c. C_1 and C_2 are both nonzero.

Solution

In region III, the wave function has the form

$$\psi_{III}(x) = D_1 e^{Kx} + D_2 e^{-Kx}$$

1. As $x \rightarrow \infty$, the wave function must vanish (why?). What does this imply for D_1 and D_2 ?

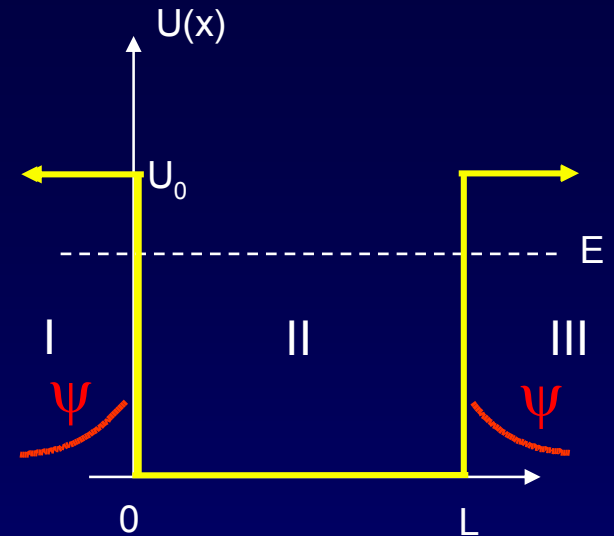

a. $D_1 = 0$

b. $D_2 = 0$

c. D_1 and D_2 are both nonzero.

Since $e^{Kx} \rightarrow \infty$ as $x \rightarrow \infty$, D_1 must be 0.

2. What can we say about the coefficients C_1 and C_2 for the wave function in region I?

$$\psi_I(x) = C_1 e^{Kx} + C_2 e^{-Kx}$$

a. $C_1 = 0$

b. $C_2 = 0$

c. C_1 and C_2 are both nonzero.

Solution

In region III, the wave function has the form

$$\psi_{III}(x) = D_1 e^{Kx} + D_2 e^{-Kx}$$

1. As $x \rightarrow \infty$, the wave function must vanish (why?). What does this imply for D_1 and D_2 ?

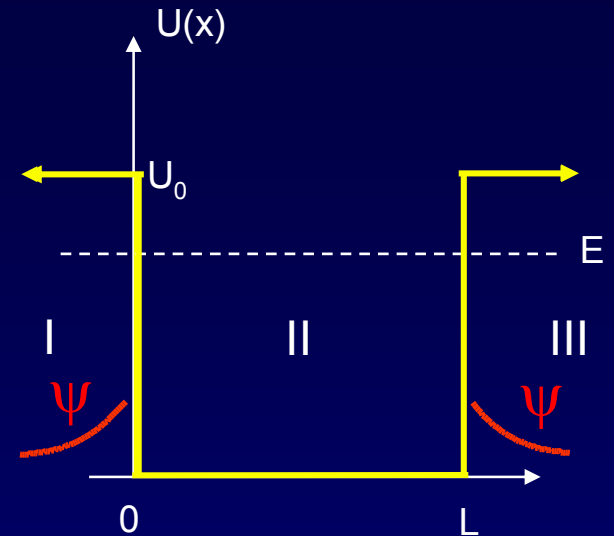

a. $D_1 = 0$

b. $D_2 = 0$

c. D_1 and D_2 are both nonzero.

Since $e^{Kx} \rightarrow \infty$ as $x \rightarrow \infty$, D_1 must be 0.

2. What can we say about the coefficients C_1 and C_2 for the wave function in region I?

$$\psi_I(x) = C_1 e^{Kx} + C_2 e^{-Kx}$$

a. $C_1 = 0$

b. $C_2 = 0$

c. C_1 and C_2 are both nonzero.

Kx is *negative* for $x < 0$. $e^{-Kx} \rightarrow \infty$ as $x \rightarrow -\infty$. So, C_2 must be 0.

Particle in a Finite Well (4)

Summarizing the solutions in the 3 regions:

Region I: $\psi_I(x) = C_1 e^{Kx}$

Region II: $\psi_{II}(x) = B_1 \sin(kx) + B_2 \cos(kx)$

Region III: $\psi_{III}(x) = D_2 e^{-Kx}$

As with the infinite square well, to determine parameters (K , k , B_1 , B_2 , C_1 , and D_2) we must apply boundary conditions.

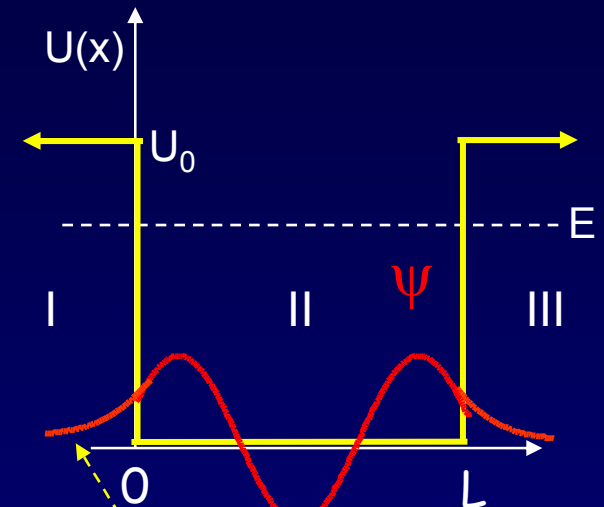

Useful to know:

In an allowed region,
 ψ curves toward 0.
In a forbidden region,
 ψ curves away from 0.

Particle in a Finite Well (5)

The boundary conditions are not the same as for the finite well. We no longer require that $\psi = 0$ at $x = 0$ and $x = L$.

Instead, we require that $\psi(x)$ and $d\psi/dx$ be continuous across the boundaries:

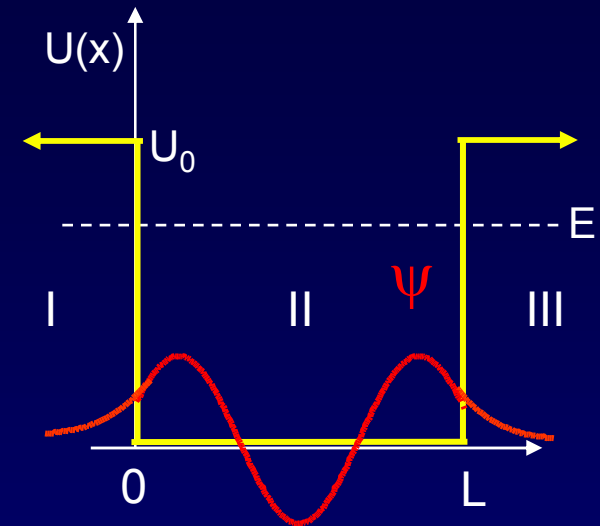

ψ is continuous

$d\psi/dx$ is continuous

At $x = 0$:

$$\psi_I = \psi_{II}$$

$$\frac{d\psi_I}{dx} = \frac{d\psi_{II}}{dx}$$

At $x = L$:

$$\psi_{II} = \psi_{III}$$

$$\frac{d\psi_{II}}{dx} = \frac{d\psi_{III}}{dx}$$

Unfortunately, this gives us a set of four transcendental equations. They can only be solved numerically (on a computer). We will discuss the qualitative features of the solutions.

Particle in a Finite Well (6)

What do the wave functions for a particle in the finite square well potential look like?

They look very similar to those for the infinite well, except ...

The particle has a finite probability to “leak out” of the well !!

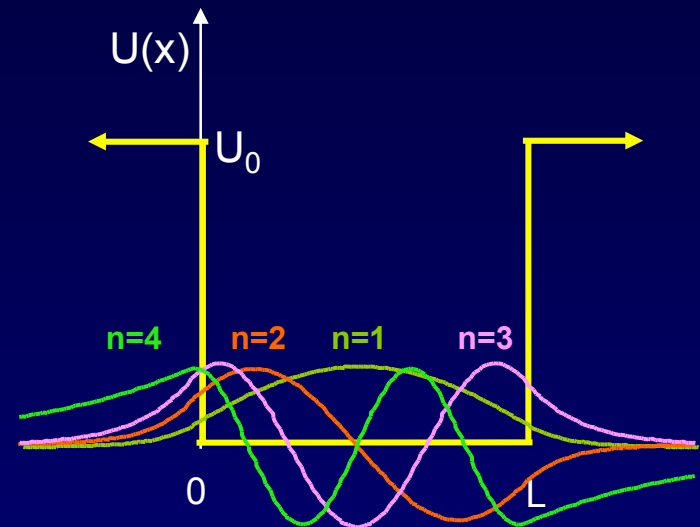

Some general features of finite wells:

- Due to leakage, the wavelength of ψ_n is longer for the finite well. Therefore E_n is lower than for the infinite well.
- K depends on $U_0 - E$. For higher E states, e^{-Kx} decreases more slowly. Therefore, their ψ penetrates farther into the forbidden region.
- A finite well has only a finite number of bound states. If $E > U_0$, the particle is no longer bound.

Very nice Java applet:
<http://www.falstad.com/qm1d/>

ACT 3

1. Which has more bound states?

- a. particle in a finite well
- b. particle in an infinite well
- c. both have the same number of bound states.

2. For a particle in a finite square well, which of the following will decrease the number of bound states?

- a. decrease well depth U_0
- b. decrease well width L
- c. decrease m , mass of particle

3. Compare the energy $E_{1,\text{finite}}$ of the lowest state of a finite well with the energy $E_{1,\text{infinite}}$ of the lowest state of an infinite well of the same width L .

a. $E_{1,\text{finite}} < E_{1,\text{infinite}}$

b. $E_{1,\text{finite}} > E_{1,\text{infinite}}$

c. $E_{1,\text{finite}} = E_{1,\text{infinite}}$

Solution

1. Which has more bound states?

- a. particle in a finite well
- b. particle in an infinite well
- c. both have the same number of bound states.

A particle in an infinite well has an *infinite* number of states.

2. For a particle in a *finite* square well, which of the following will decrease the number of bound states?

- a. decrease well depth U_0
- b. decrease well width L
- c. decrease m , mass of particle

3. Compare the energy $E_{1,\text{finite}}$ of the lowest state of a finite well with the energy $E_{1,\text{infinite}}$ of the lowest state of an infinite well of the same width L .

a. $E_{1,\text{finite}} < E_{1,\text{infinite}}$

b. $E_{1,\text{finite}} > E_{1,\text{infinite}}$

c. $E_{1,\text{finite}} = E_{1,\text{infinite}}$

Solution

1. Which has more bound states?

- a. particle in a finite well
- b. particle in an infinite well
- c. both have the same number of bound states.

A particle in an infinite well has an *infinite* number of states.

2. For a particle in a *finite* square well, which of the following will decrease the number of bound states?

- a. decrease well depth U_0
- b. decrease well width L
- c. decrease m , mass of particle

All three choices are correct:
a makes fewer energy levels have $E < U_0$.
b and c raise the energy of each energy level.

NOTE: For a particle in a 1-dimensional potential well, there is always at least one bound state.

Solution

3. Compare the energy $E_{1,\text{finite}}$ of the lowest state of a finite well with the energy $E_{1,\text{infinite}}$ of the lowest state of an infinite well of the same width L .

a. $E_{1,\text{finite}} < E_{1,\text{infinite}}$

b. $E_{1,\text{finite}} > E_{1,\text{infinite}}$

c. $E_{1,\text{finite}} = E_{1,\text{infinite}}$

Look at the wavefunctions for the two situations:

www.falstad.com/qm1d

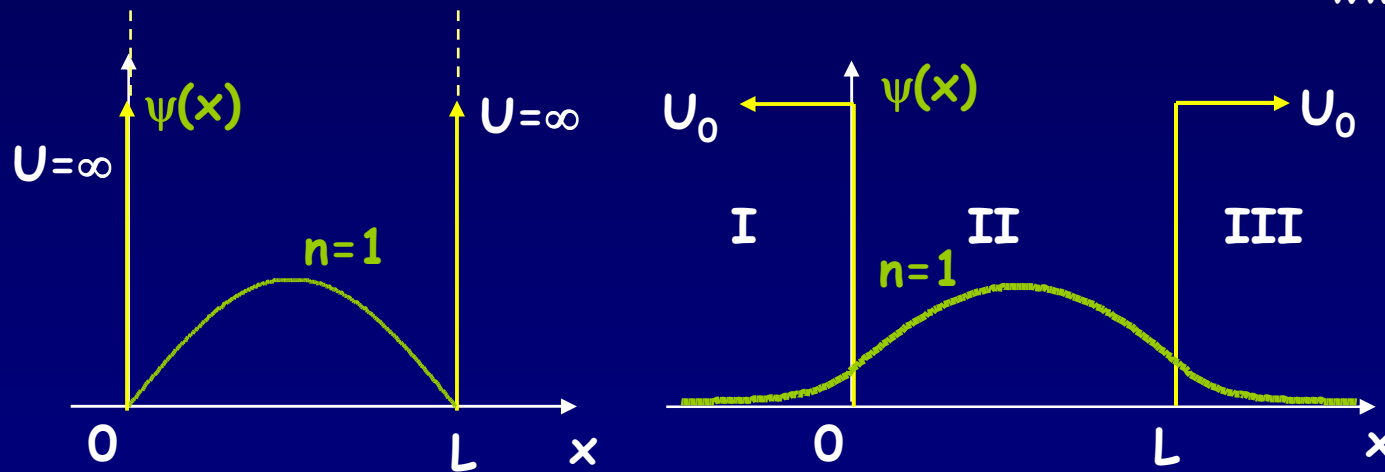

The wavelength in the finite well is longer, because it is not required to go to zero at $x = 0$ and $x = L$ (it “leaks” out a little). Thus, the momentum $p = h/\lambda$ is smaller, and so is the energy. That’s true in general; the less one confines an object, the lower its energy can be - a consequence of the Heisenberg Uncertainty Principle.

Kruse Demo
(wvfn)

Summary

Particle in a finite square well potential

- Solving boundary conditions:
You'll do it with a computer in lab. We described it qualitatively here.
- Particle can “leak” into forbidden region.
We'll discuss this more later (tunneling).
- Comparison with infinite-well potential:
The energy of state n is lower in the finite square well potential of the same width.
We can understand this from the uncertainty principle.

Next Week

- Superposition of states and particle motion
- Measurement in quantum physics
- Schrödinger's Cat
- Time-Energy Uncertainty Principle