

"Quantum mechanics' is the description of the behavior of matter and light in all its details and, in particular, of the happenings on an atomic scale. Things on a very small scale behave like nothing that you have any direct experience about. They do not behave like waves, they do not behave like particles, they do not behave like clouds, or billiard balls, or weights on springs, or like anything that you have ever seen."

--Richard P. Feynman

Lecture 10: The Schrödinger Equation

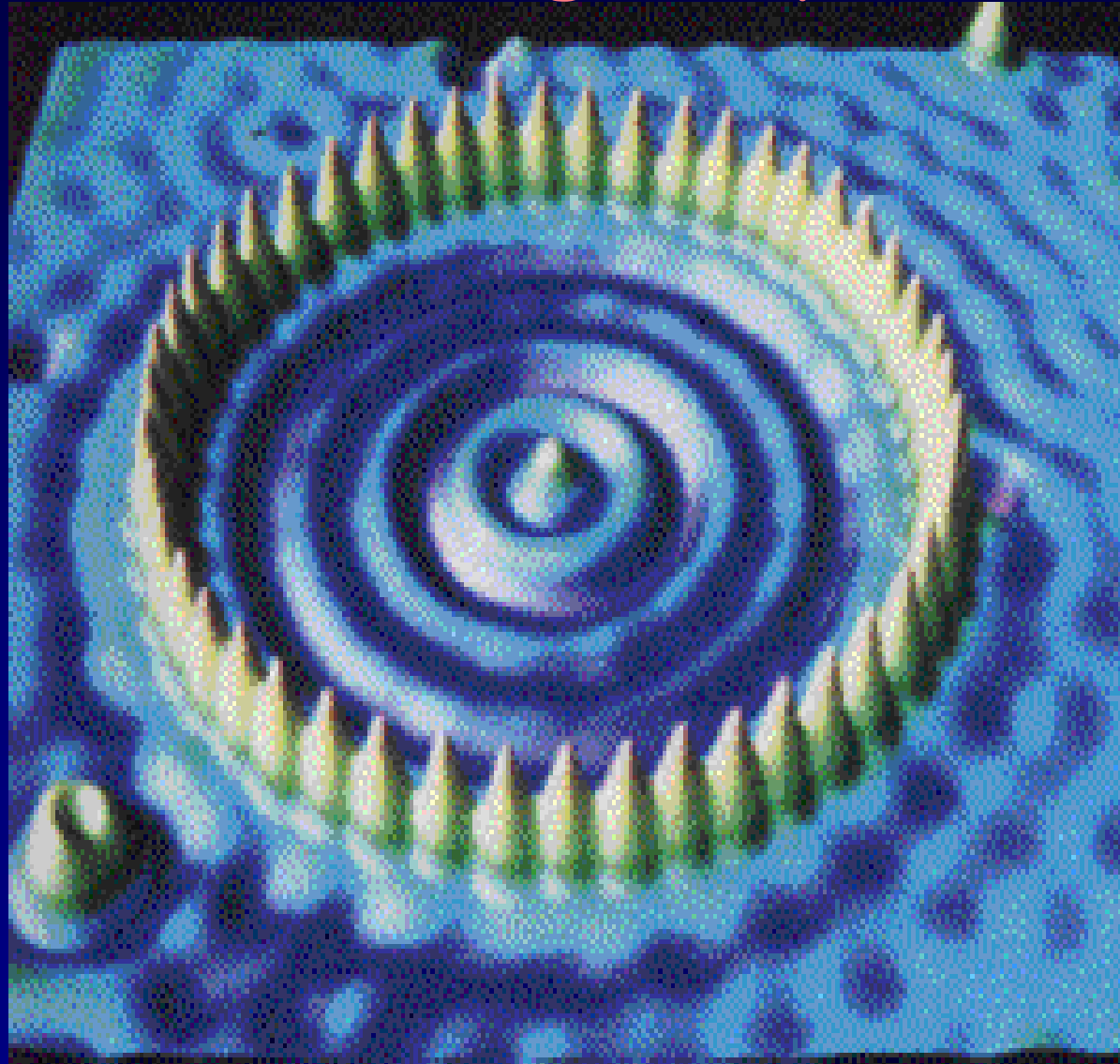

This week and last week are critical for the course:

Week 3, Lectures 7-9:

Light as Particles
Particles as waves
Probability
Uncertainty Principle

Week 4, Lectures 10-12:

Schrödinger Equation
Particles in infinite wells, finite wells
Simple Harmonic Oscillator

Midterm Exam Monday, week 5

It will cover lectures 1-12 (except Simple Harmonic Oscillators)

Practice exams: Old exams are linked from the course web page.

Review: Sunday before Midterm

Office hours: Sunday and Monday

Next week:

Homework 4 covers material in lecture 10 – due on Thur. after midterm.

We strongly encourage you to **look at the homework before the midterm!**

Discussion: Covers material in lectures 10-12. There will be a **quiz**.

Lab: **Go to 257 Loomis** (a computer room).

You can save a lot of time by reading the lab ahead of time –
It's a tutorial on how to draw wave functions.

Overview

Probability distributions

Schrödinger's Equation

Particle in a "Box"

Matter waves in an infinite square well

Quantized energy levels

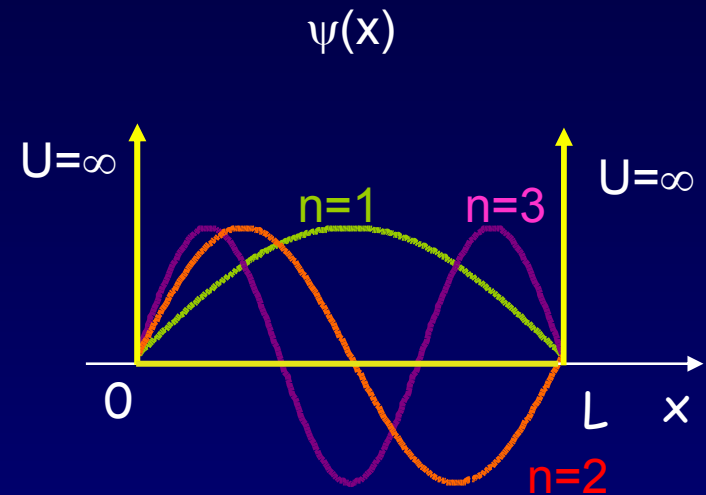

Nice descriptions in the text – Chapter 40

Good web site for animations <http://www.falstad.com/qm1d/>

Matter Waves - Quantitative

Having established that matter acts *qualitatively* like a wave, **we want to be able to make precise *quantitative* predictions**, under given conditions. Usually the conditions are specified by giving a potential energy $U(x,y,z)$ in which the particle is located.

Examples:

Electron in the coulomb potential produced by the nucleus

Electron in a molecule

Electron in a solid crystal

Electron in a nanostructure 'quantum dot'

Proton in the nuclear potential inside the nucleus

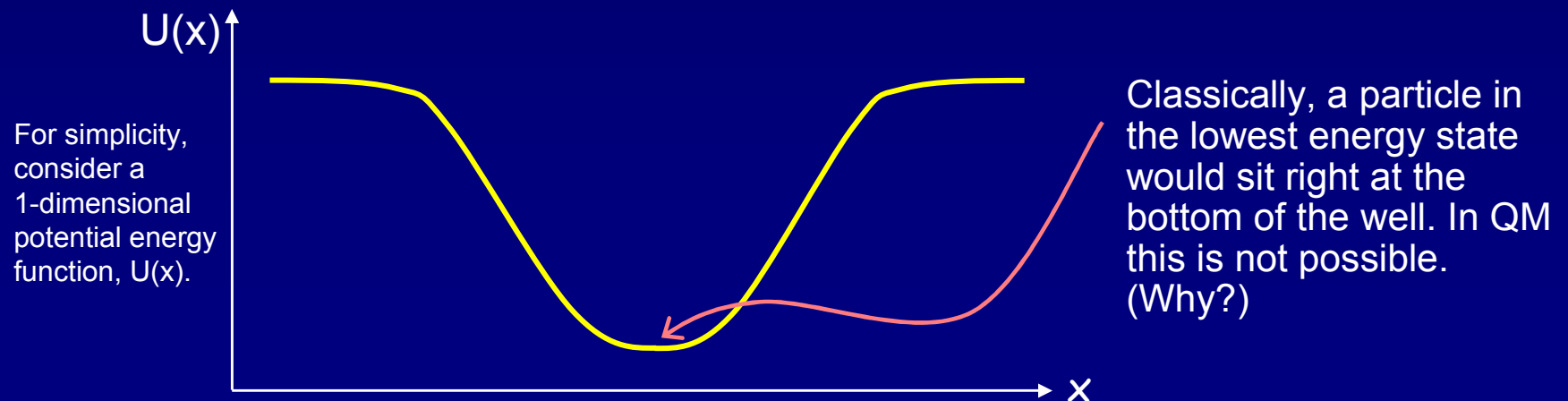

Act 1: Classical probability distributions

Start a classical (large) object moving in a potential well (two are shown here). At some random time later, what is the probability of finding it near position x ?

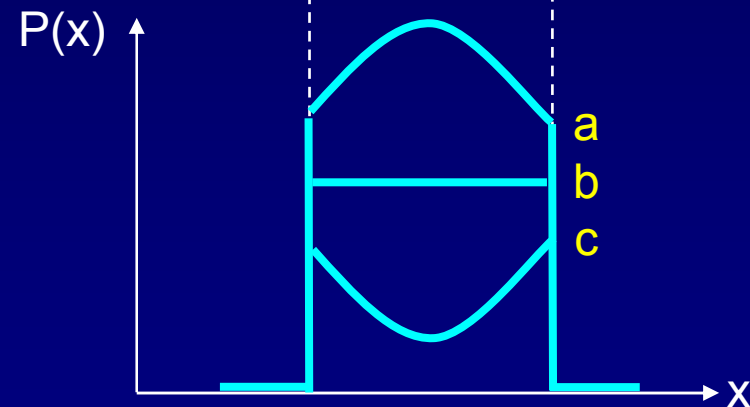
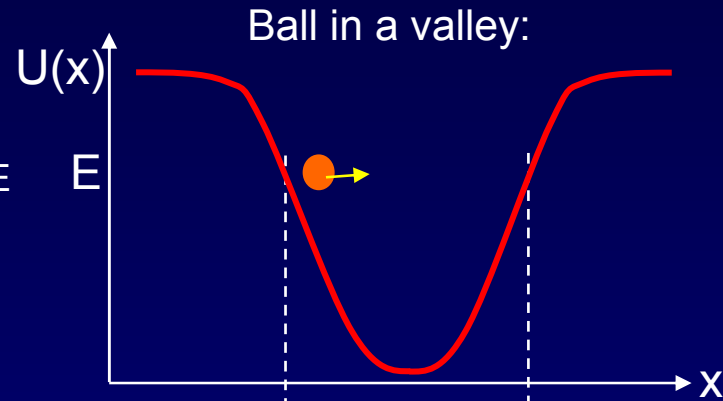
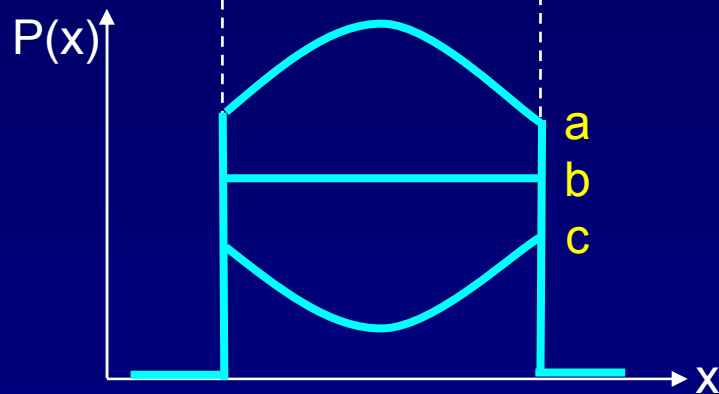
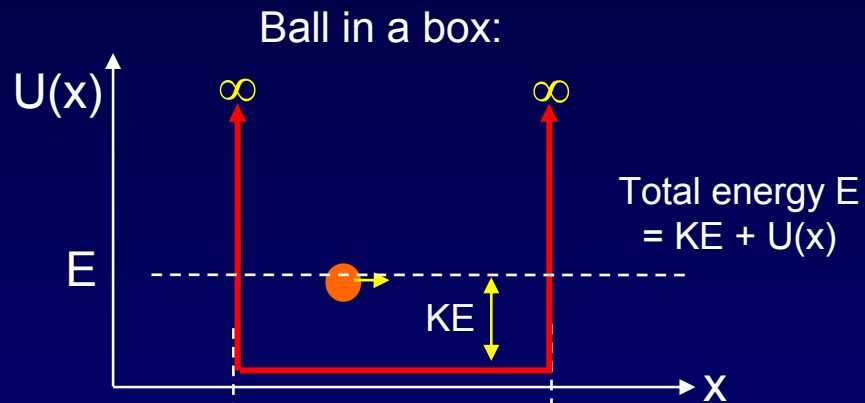

HINT: Think about speed vs position.

Solution

Start a classical (large) object moving in a potential well (two are shown here). At some random time later, what is the probability of finding it near position x ?

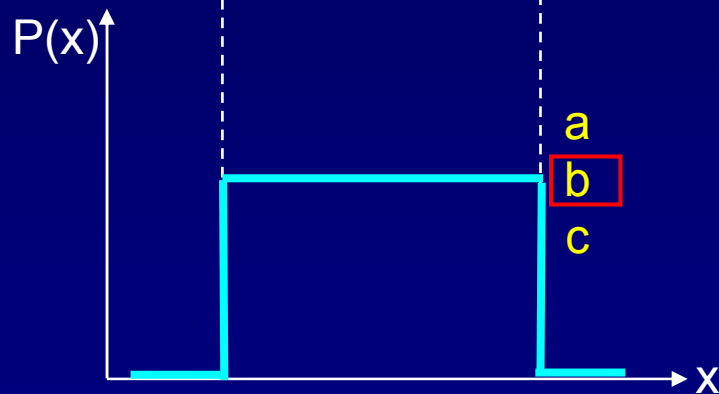
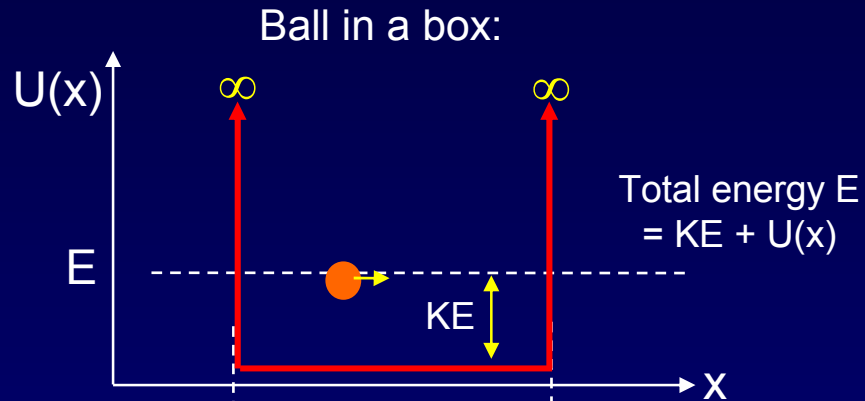

Probability is equally distributed

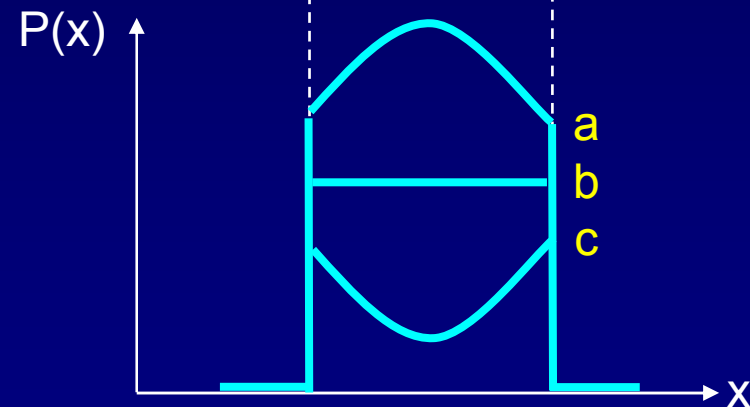
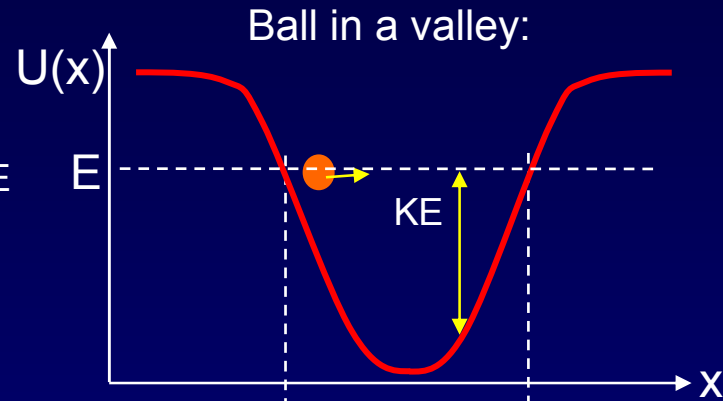

Solution

Start a classical (large) object moving in a potential well (two are shown here). At some random time later, what is the probability of finding it near position x ?

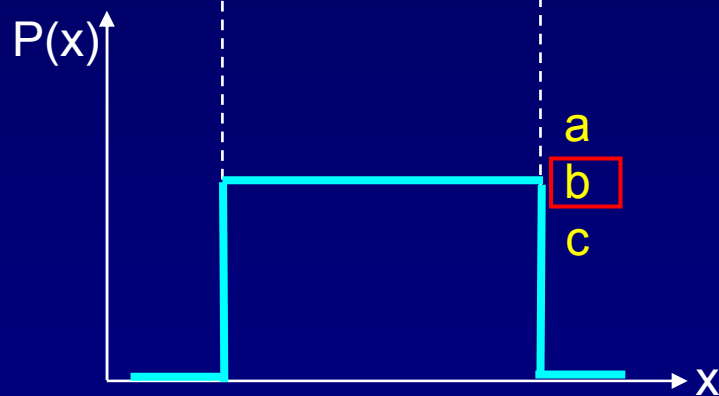
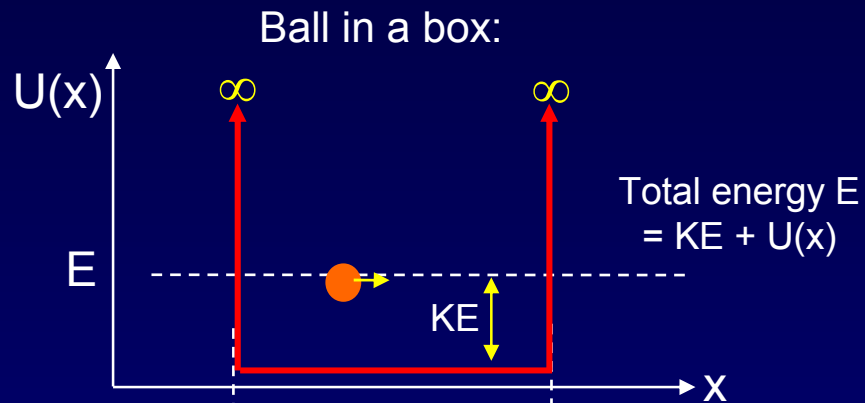

Probability is equally distributed

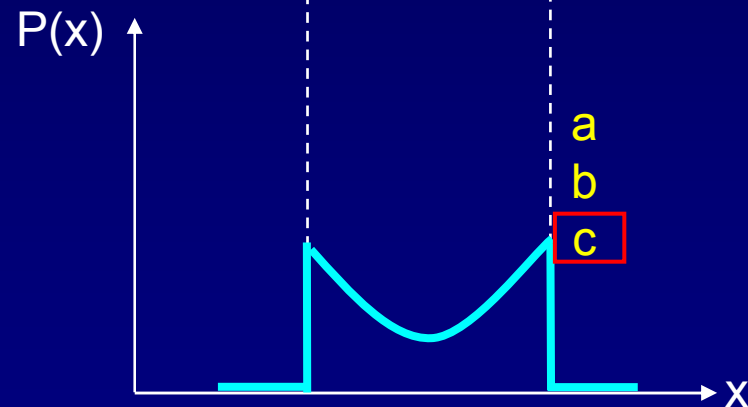
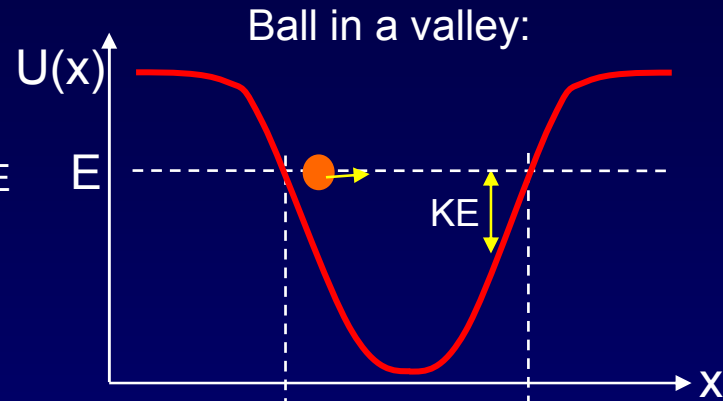

More likely to spend time at the edges.

To predict a quantum particle's behavior, we need an equation that tells us how the particle's wave function, $\Psi(x,y,z,t)$, changes in space and time.

The Schrödinger Equation (SEQ)

In 1926, Erwin Schrödinger proposed an equation that described the time- and space-dependence of the wave function for matter waves (*i.e.*, electrons, protons,...)

There are two important forms for the SEQ.

First we will focus on a very important special case of the SEQ, the time-independent SEQ. Also simplify to 1-dimension: $\psi(x,y,z) \rightarrow \psi(x)$.

$$-\frac{\hbar^2}{2m} \frac{d^2 \psi(x)}{dx^2} + U(x)\psi(x) = E\psi(x) \quad \hbar = \frac{h}{2\pi}$$

This special case applies when the particle has a definite total energy (E in the equation). We'll consider the more general case (E has a probability distribution), and also 2D and 3D motion, later.

QM entities don't always have a definite energy.

Time does not appear in the equation. Therefore, $\psi(x,y,z)$ is a standing wave, because the probability density, $|\psi(x)|^2$, is not a function of time. We call $\psi(x,y,z)$ a "stationary state".

Notation:
Distinguish $\Psi(x,y,z,t)$ from $\psi(x,y,z)$.

Time-Independent SEQ

What does the time-independent SEQ represent?

It's actually not so puzzling...it's just an expression of a familiar result:

Kinetic Energy (KE) + Potential Energy (PE) = Total Energy (E)

$$-\frac{\hbar^2}{2m} \frac{d^2 \psi(x)}{dx^2} + U(x)\psi(x) = E\psi(x)$$

KE term PE term Total E term

Can we understand the KE term? Consider a particle with a definite momentum. Its wave function is: $\psi(x) \propto \cos(kx)$, where $p = h/\lambda = \hbar k$.

$$\frac{d\psi}{dx} = -k \sin(kx) \Rightarrow \frac{d^2\psi}{dx^2} = -k^2 \cos(kx) = -\frac{p^2}{\hbar^2} \psi(x)$$

So, the first term in the SEQ is $(p^2/2m)\psi$.

Note that the KE of the particle depends on the curvature ($d^2\psi/dx^2$) of the wave function. This is sometimes useful when analyzing a problem.

Particle Wavefunctions: Examples

What do the solutions to the SEQ look like for general $U(x)$?

Examples of $\psi(x)$ for a particle in a given potential $U(x)$ (but with different E):

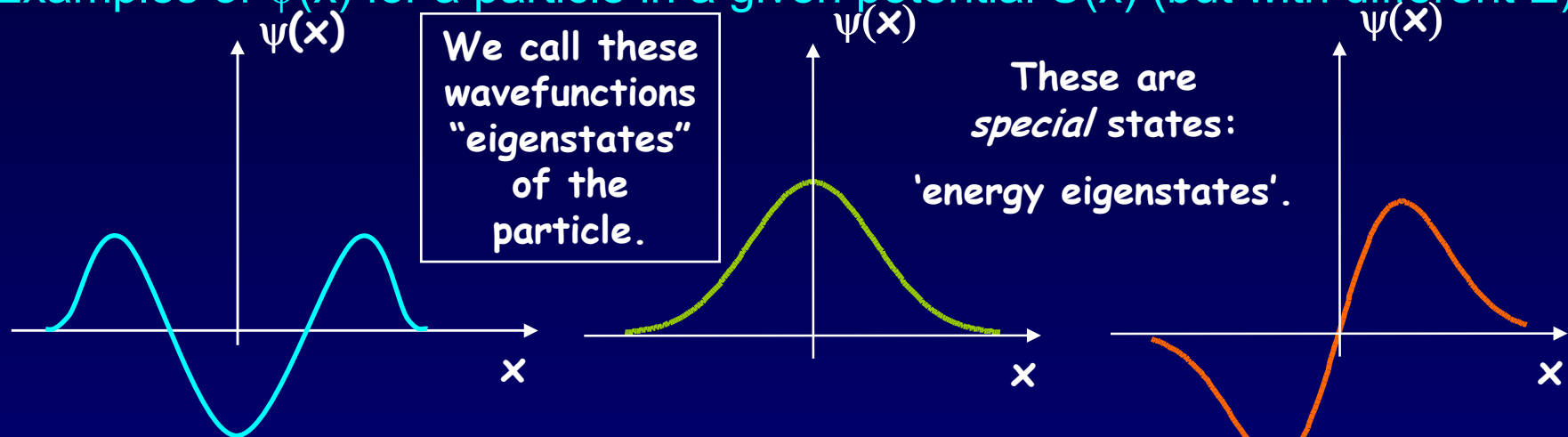

The corresponding probability distributions $|\psi(x)|^2$ of these states are:

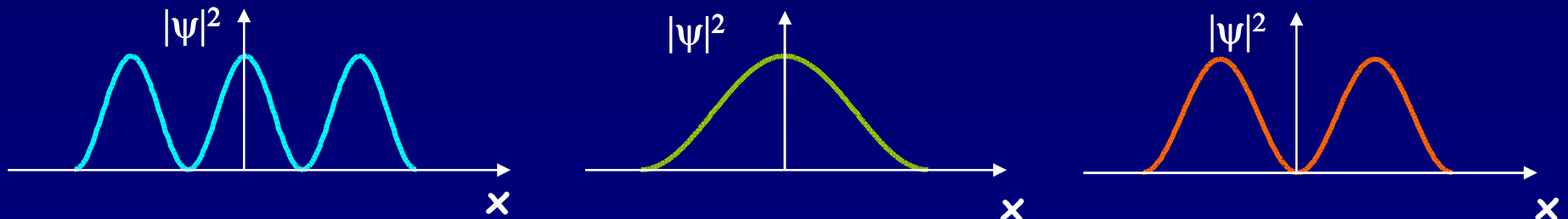

Key point: Particle cannot be associated with a specific location x .

-- like the uncertainty that a particle went through slit 1 or slit 2.

Question: Which corresponds to the lowest/highest kinetic energy?

The particle kinetic energy is proportional to the *curvature* of the wave function.

Probability distribution

Difference between classical and quantum cases

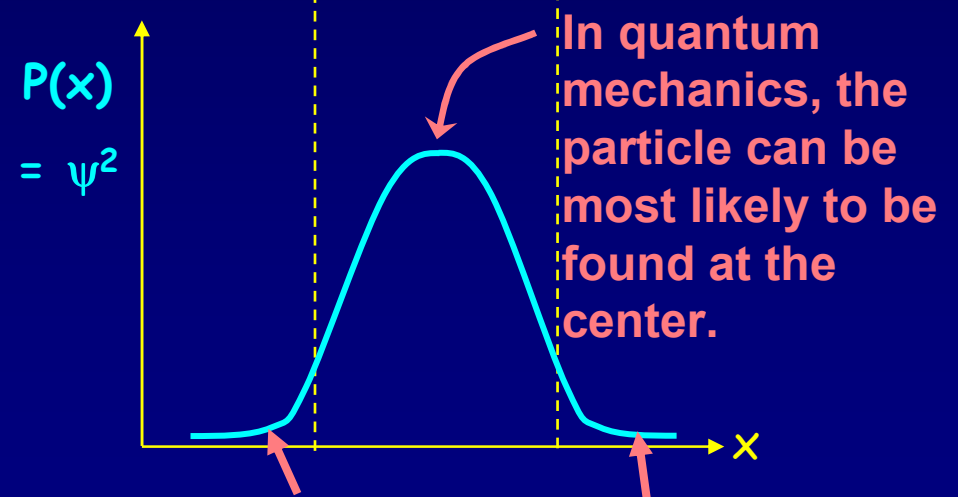
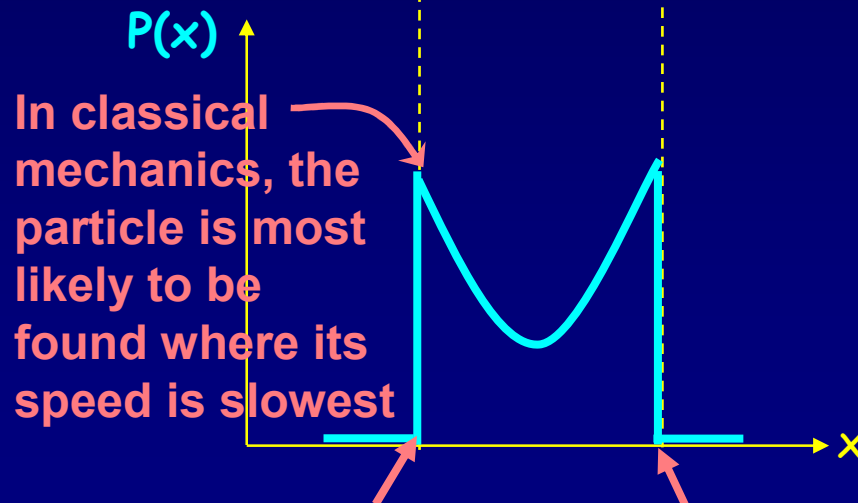
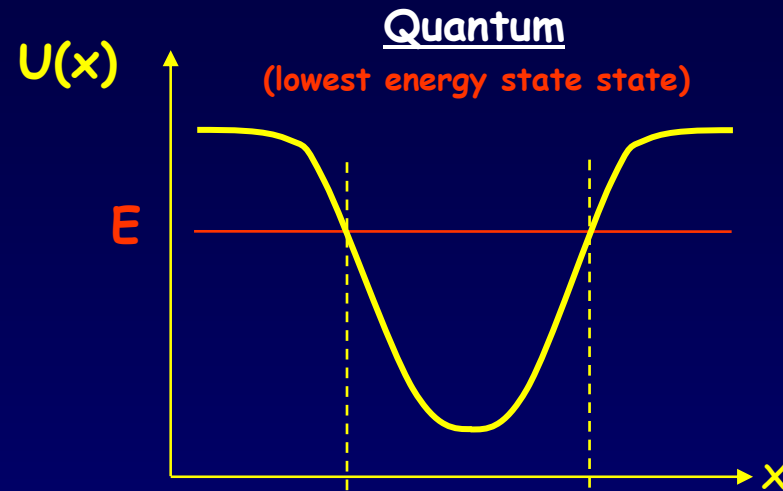
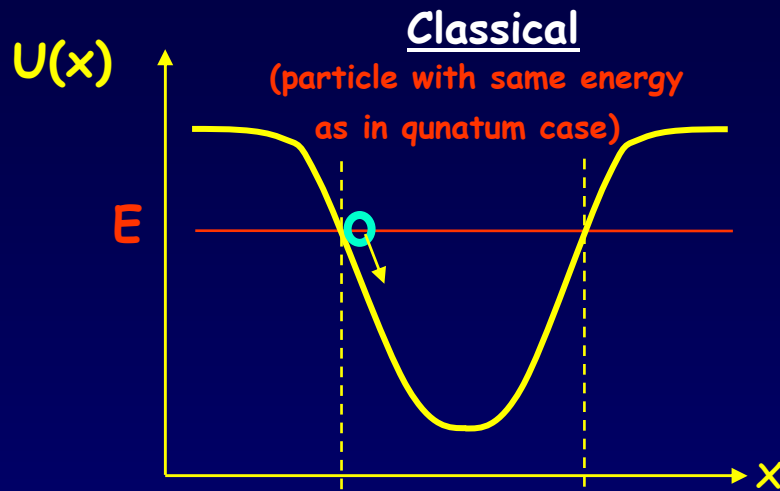

In classical mechanics, the particle moves back and forth coming to rest at each "turning point"

In quantum mechanics, the particle can also be found where it is "forbidden" in classical mechanics.

Solutions to the time-independent SEQ

$$-\frac{\hbar^2}{2m} \frac{d^2 \psi(x)}{dx^2} + U(x)\psi(x) = E\psi(x)$$

Notice that if $U(x) = \text{constant}$, this equation has the simple form:

$$\frac{d^2 \psi}{dx^2} = C\psi(x)$$

where $C = \frac{2m}{\hbar^2}(U - E)$ is a constant that might be positive or negative.

For positive C (i.e., $U > E$), what is the form of the solution?

- a) $\sin kx$ b) $\cos kx$ c) e^{ax} d) e^{-ax}

For negative C ($U < E$) what is the form of the solution?

- a) $\sin kx$ b) $\cos kx$ c) e^{ax} d) e^{-ax}

Most of the wave functions in P214 will be sinusoidal or exponential.

Solution

$$-\frac{\hbar^2}{2m} \frac{d^2 \psi(x)}{dx^2} + U(x)\psi(x) = E\psi(x)$$

Notice that if $U(x) = \text{constant}$, this equation has the simple form:

$$\frac{d^2 \psi}{dx^2} = C\psi(x)$$

where $C = \frac{2m}{\hbar^2}(U - E)$ is a constant that might be positive or negative.

For positive C (i.e., $U > E$), what is the form of the solution?

- a) $\sin kx$ b) $\cos kx$ **c) e^{ax}** **d) e^{-ax}**

For negative C ($U < E$) what is the form of the solution?

- a) $\sin kx$** **b) $\cos kx$** c) e^{ax} d) e^{-ax}

Most of the wave functions in P214 will be sinusoidal or exponential.

Example: "Particle in a Box"

As a specific important example, consider a quantum particle confined to a region, $0 < x < L$, by infinite potential walls. We call this a "one-dimensional (1D) box".

$$U = 0 \text{ for } 0 < x < L$$

$$U = \infty \text{ everywhere else}$$

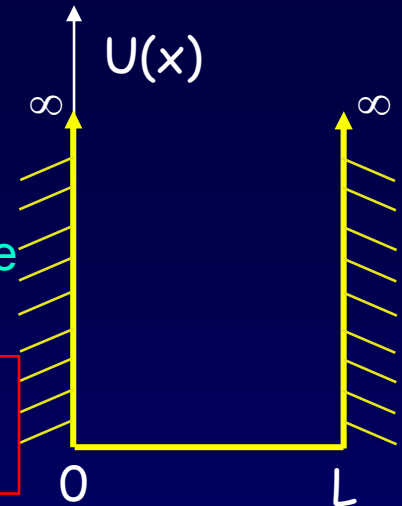

We already know the form of ψ when $U = 0$: $\sin(kx)$ or $\cos(kx)$. However, we can constrain ψ more than this.

The waves have exactly the same form as standing waves on a string, sound waves in a pipe, etc.

The wavelength is determined by the condition that it fits in the box.

On a string the wave is a displacement $y(x)$ and the square is the intensity, etc. The discrete set of allowed wavelengths results in a discrete set of tones that the string can produce.

In a quantum box, the wave is the probability amplitude $\psi(x)$ and the square $|\psi(x)|^2$ is the probability of finding the electron near point x . The discrete set of allowed wavelengths results in a discrete set of allowed energies that the particle can have.

Boundary conditions → Standing waves

- A standing wave is the solution for a wave confined to a region
- Boundary condition: Constraints on a wave where the potential changes
 - Displacement = 0 for wave on string
 - $E = 0$ at surface of a conductor

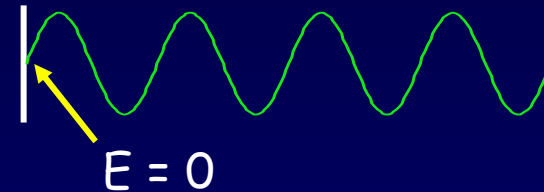
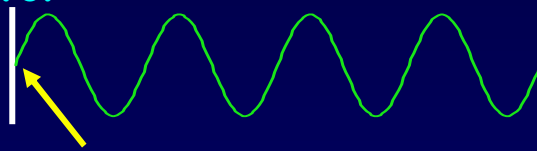

- If *both* ends are constrained (e.g., for a cavity of length L), then only certain wavelengths λ are possible:

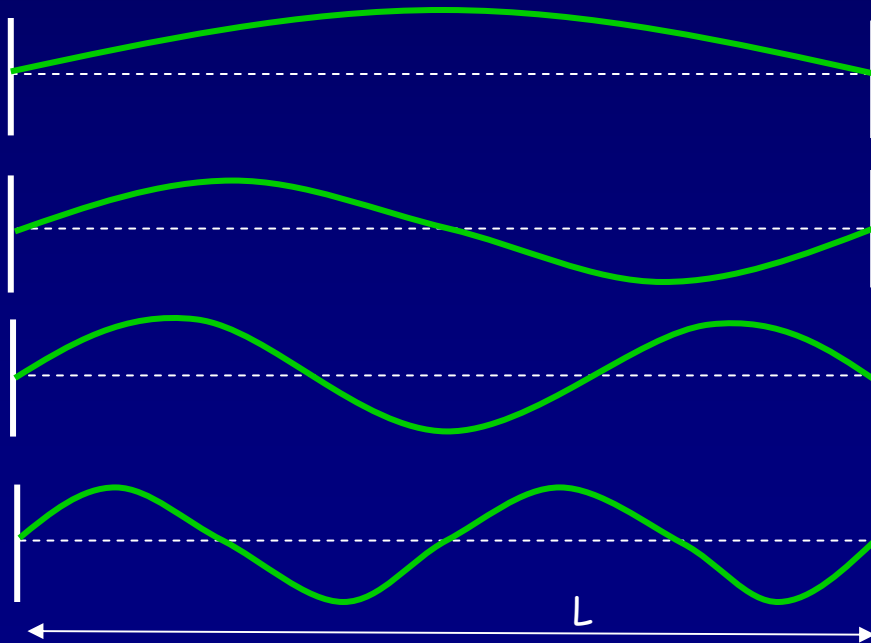

n	λ	f
1	$2L$	$v/2L$
2	L	v/L
3	$2L/3$	$3v/2L$
4	$L/2$	$2v/L$
n	$2L/n$	$nv/2L$

$$n\lambda = 2L$$

$n = 1, 2, 3 \dots$
'mode index'

The Energy is Quantized Due to Confinement by the Potential

The discrete E_n are known as “energy eigenvalues”:

$$n\lambda_n = 2L$$

$$E_n = \frac{p^2}{2m} = \frac{h^2}{2m\lambda_n^2} = \frac{1.505 \text{ eV} \cdot \text{nm}^2}{\lambda_n^2}$$

electron
↓

$E_n = E_1 n^2$

where

$E_1 \equiv \frac{h^2}{8mL^2}$

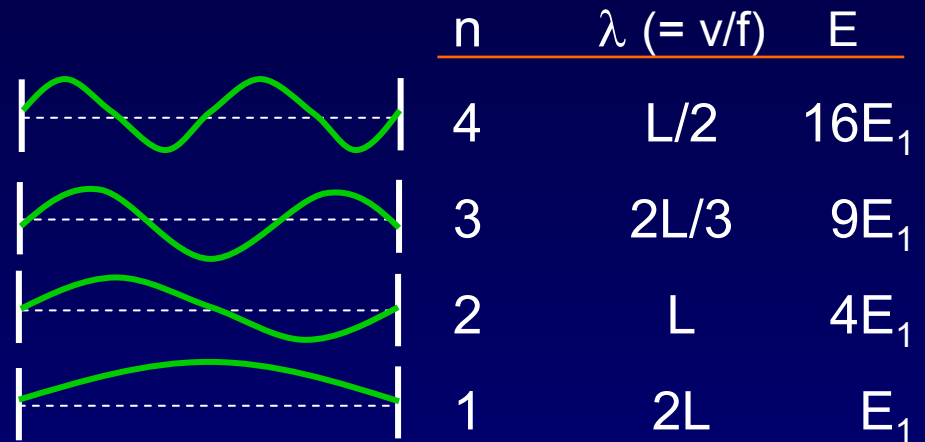

Important features:

- Discrete energy levels.
- $E_1 \neq 0$ ← an example of the uncertainty principle
- Standing wave ($\pm p$ for a given E)
- $n = 0$ is not allowed. (why?)

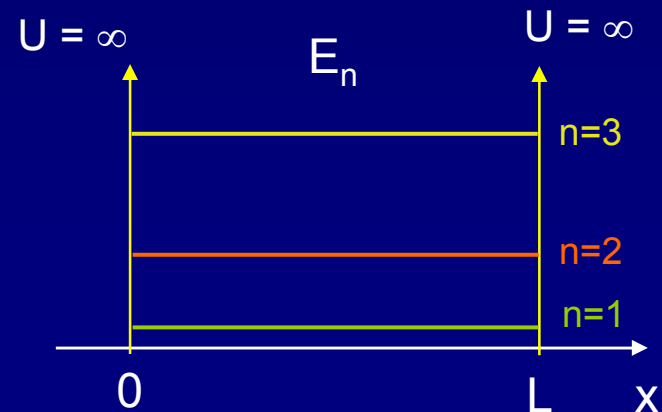

Quantum Wire Example

An electron is trapped in a “quantum wire” that is $L = 4$ nm long. Assume that the potential seen by the electron is approximately that of an **infinite square well**.

1: Calculate the ground (lowest) state energy of the electron.

2: What photon energy is required to excite the trapped electron to the next available energy level (*i.e.*, $n = 2$)?

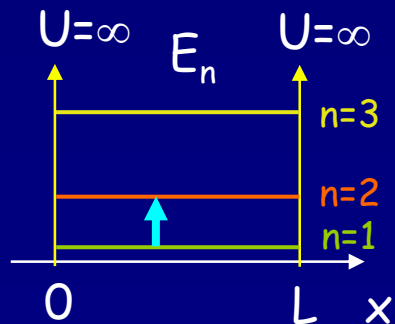

The idea here is that the photon is absorbed by the electron, which gains all of the photon's energy (similar to the photoelectric effect).

Solution

An electron is trapped in a “quantum wire” that is $L = 4 \text{ nm}$ long. Assume that the potential seen by the electron is approximately that of an infinite square well.

1: Calculate the ground (lowest) state energy of the electron.

$$E_n = E_1 n^2 \quad \text{with} \quad E_1 = \frac{h^2}{8mL^2} = \frac{1.505 \text{ eV} \cdot \text{nm}^2}{4L^2}$$

$$E_1 = \frac{1.505 \text{ eV} \cdot \text{nm}^2}{4(4\text{nm})^2} = \boxed{0.0235 \text{ eV}}$$

Using:

$$E = \frac{h^2}{2m\lambda^2} = \frac{1.505 \text{ eV} \cdot \text{nm}^2}{\lambda^2}$$

where $\lambda = 2L$.

2: What photon energy is required to excite the trapped electron to the next available energy level (i.e., $n = 2$)?

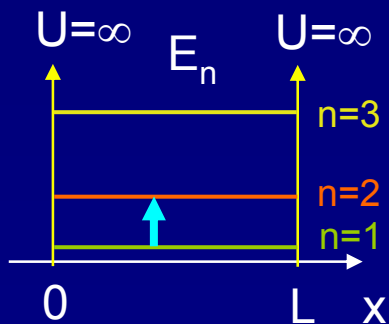

$$E_n = n^2 E_1$$

So, the energy difference between the $n = 2$ and $n = 1$ levels is:

$$\Delta E = (2^2 - 1^2)E_1 = 3E_1 = \boxed{0.071 \text{ eV}}$$

Boundary conditions

We can solve the SEQ wherever we know $U(x)$. However, in many problems, including the 1D box, $U(x)$ has different functional forms in different regions. In our box problem, there are three regions:

1: $x < 0$

2: $0 < x < L$

3: $x > L$

$\psi(x)$ will have different functional forms in the different regions.

We must make sure that $\psi(x)$ satisfies the constraints (e.g., continuity) at the boundaries between these regions.

The extra conditions that ψ must satisfy are called “boundary conditions”. They appear in many problems.

Particle in a Box (1)

Regions 1 and 3 are identical, so we really only need to deal with two distinct regions, (I) outside, and (II) inside the well

Region I: When $U = \infty$, what is $\psi(x)$?

$$\frac{d^2 \psi(x)}{dx^2} + \frac{2m}{\hbar^2} (E - U) \psi(x) = 0$$

For $U = \infty$, the SEQ can only be satisfied if:

$$\psi_I(x) = 0$$

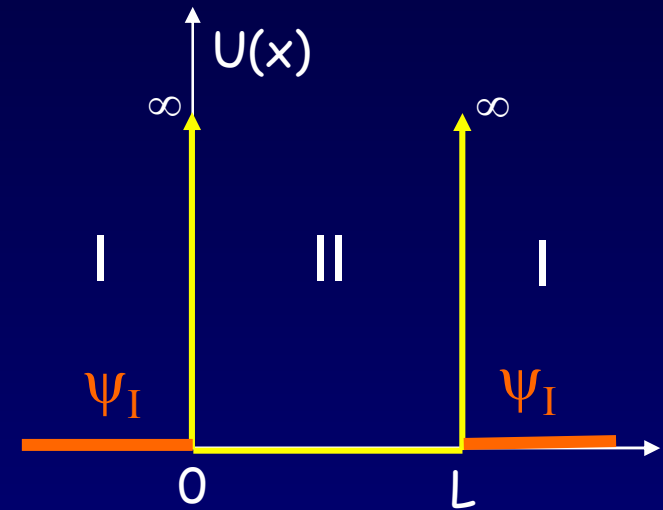

$$U = 0 \text{ for } 0 < x < L$$

$$U = \infty \text{ everywhere else}$$

Otherwise, the energy would have to be infinite, to cancel U .

Note: The infinite well is an idealization.
There are no infinitely high and sharp barriers.

Particle in a Box (2)

Region II: When $U = 0$, what is $\psi(x)$?

$$\frac{d^2 \psi(x)}{dx^2} + \frac{2m}{\hbar^2} (E - U) \psi(x) = 0$$

$$\frac{d^2 \psi(x)}{dx^2} = - \left(\frac{2mE}{\hbar^2} \right) \psi(x)$$

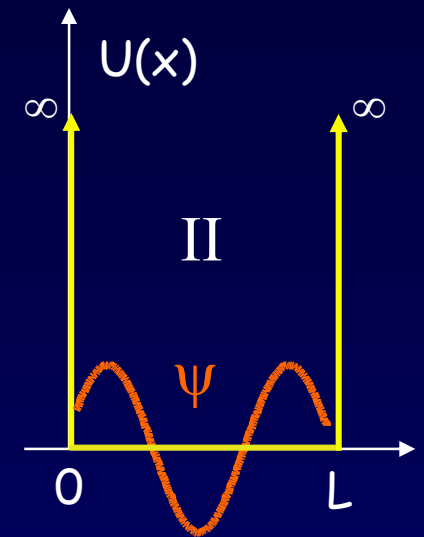

The general solution is a superposition of sin and cos:

$$\psi(x) = B_1 \sin kx + B_2 \cos kx \quad \text{where, } k = \frac{2\pi}{\lambda}$$

Remember that k and E are related:

$$E = \frac{p^2}{2m} = \frac{\hbar^2 k^2}{2m} = \frac{h^2}{2m\lambda^2} \quad \text{because } U = 0$$

B_1 and B_2 are coefficients to be determined by the boundary conditions.

Particle in a Box (3)

Now, let's worry about the boundary conditions.
Match ψ at the left boundary ($x = 0$).

Region I: $\psi_I(x) = 0$

Region II: $\psi_{II}(x) = B_1 \sin kx + B_2 \cos kx$

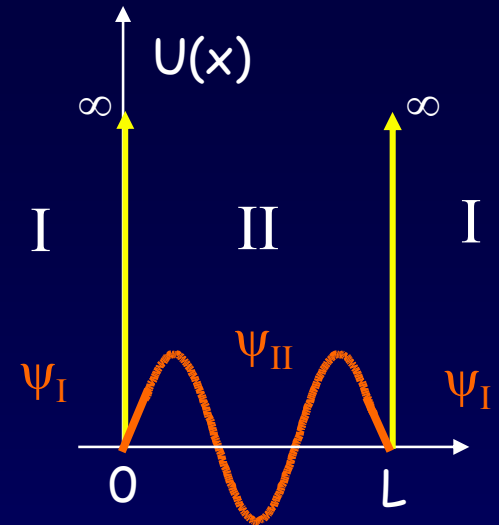

Recall: The wave function $\psi(x)$ must be continuous at all boundaries.
Therefore, at $x = 0$:

$$\psi_I(0) = \psi_{II}(0)$$

$$\Rightarrow 0 = B_1 \sin(0) + B_2 \cos(0)$$

$$0 = B_2$$

because $\cos(0) = 1$ and $\sin(0) = 0$

This “boundary condition” requires that there be no $\cos(kx)$ term!

Particle in a Box (4)

Now, match ψ at the right boundary ($x = L$).

At $x = L$: $\psi_I(L) = \psi_{II}(L)$

$\Rightarrow 0 = B_1 \sin(kL)$

This constraint requires k to have special values:

$k_n = \frac{n\pi}{L}$ $n = 1, 2, \dots$ Using $k = \frac{2\pi}{\lambda}$, we find: $n\lambda_n = 2L$

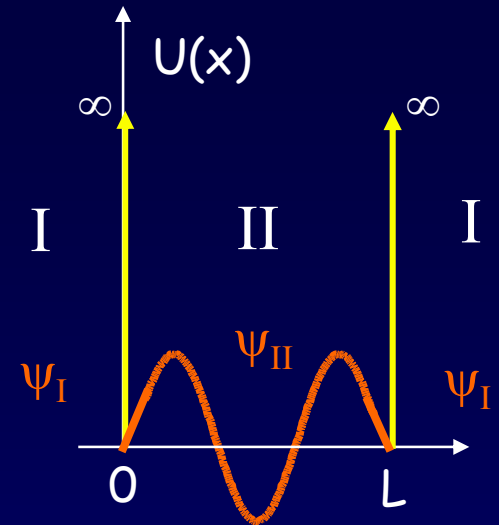

This is the same condition we found for confined waves, e.g., waves on a string, EM waves in a laser cavity, etc.:

n	$\lambda (= v/f)$
4	$L/2$
3	$2L/3$
2	L
1	$2L$

For matter waves, the wavelength is related to the particle energy:

$E = h^2/2m\lambda^2$

$\rightarrow E_n = E_1 n^2$ where $E_1 \equiv \frac{h^2}{8mL^2}$

Next Lectures

“Normalizing” the wavefunction

General properties of bound-state wavefunctions

Finite-depth square well potential (more realistic)