

# Lecture 20: Solids - Metals, Insulators, and Semiconductors

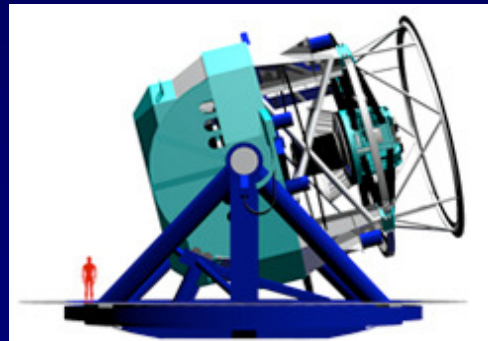
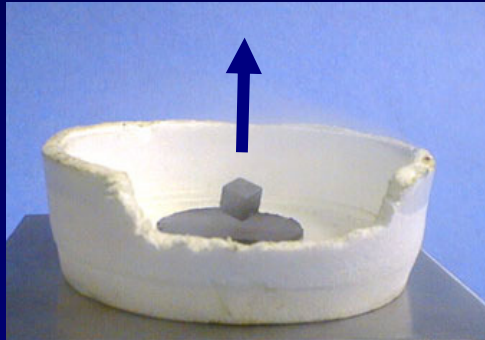

# Today

Electron energy bands in Solids

States in atoms with many electrons -  
filled according to the Pauli exclusion principle

Why do some solids conduct – others do not – others are intermediate

Metals, Insulators and Semiconductors

Understood in terms of Energy Bands and the Exclusion Principle

Solid-state semiconductor devices

The electronic states in semiconductors

Transistors, . . .

Superconductivity

Electrical conduction with zero resistance!

All the electrons in a metal cooperate to form a single quantum state

# Electron states in a crystal (1)

Again start with a simple atomic state:

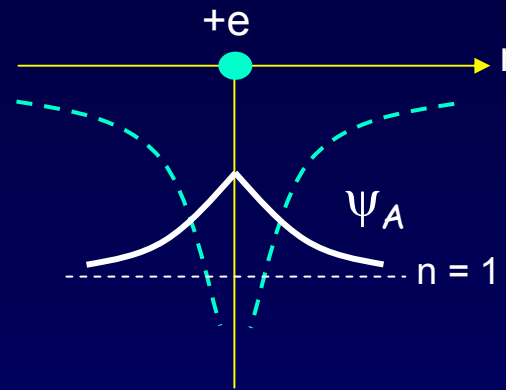

Bring  $N$  atoms together to form a 1-d crystal (a periodic lattice).

$N$  atomic states  $\rightarrow$   $N$  crystal states.  
What do these crystal states look like?

Like molecular bonding, the total wave function is (approximately) just a superposition of 1-atom orbitals.

# Electron states in a crystal (2)

The lowest energy combination is just the sum of the atomic states.  
This is a generalization of the 2-atom bonding state.

No nodes!  
Lowest energy.

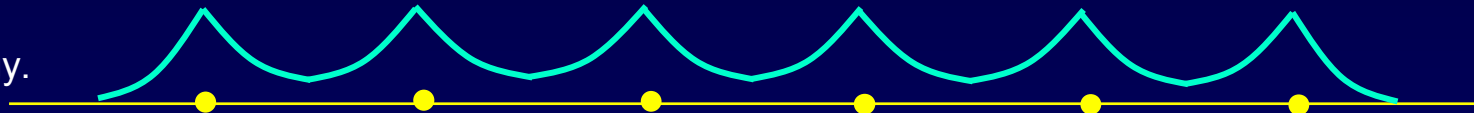

The highest energy state is the one where every adjacent pair of atoms has a minus sign:

N-1 nodes!  
Highest energy.

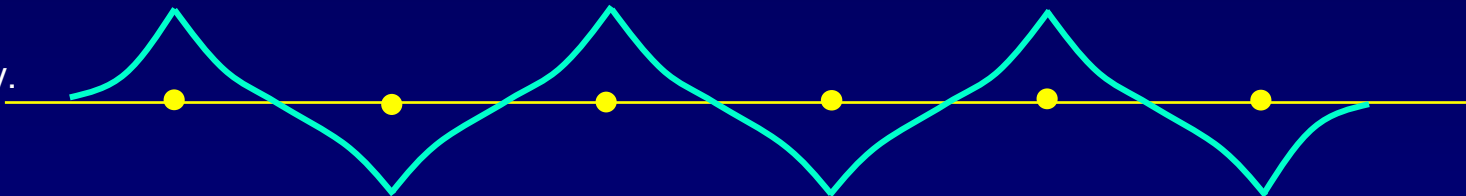

There are N states, with energies lying between these extremes.

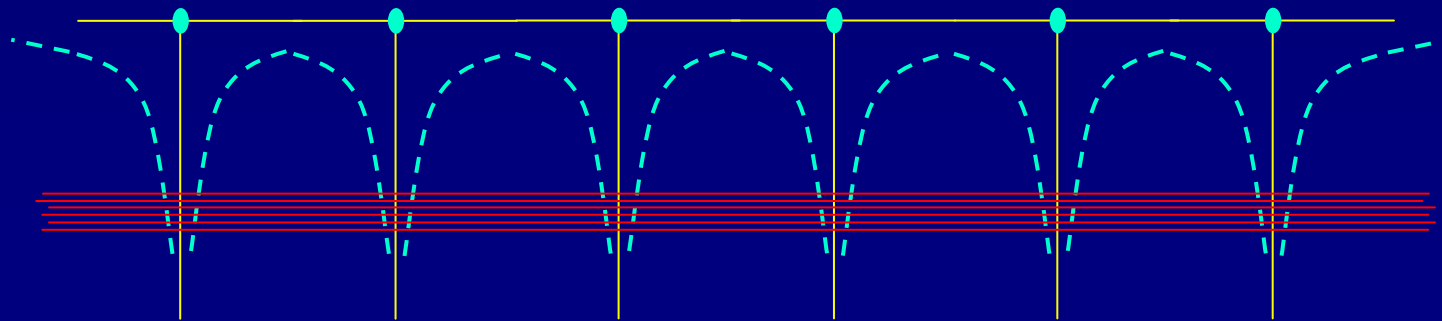

# Energy Band Wave Functions

Example with six atoms  $\rightarrow$  six crystal wave functions in each band.

Highest energy wavefunction

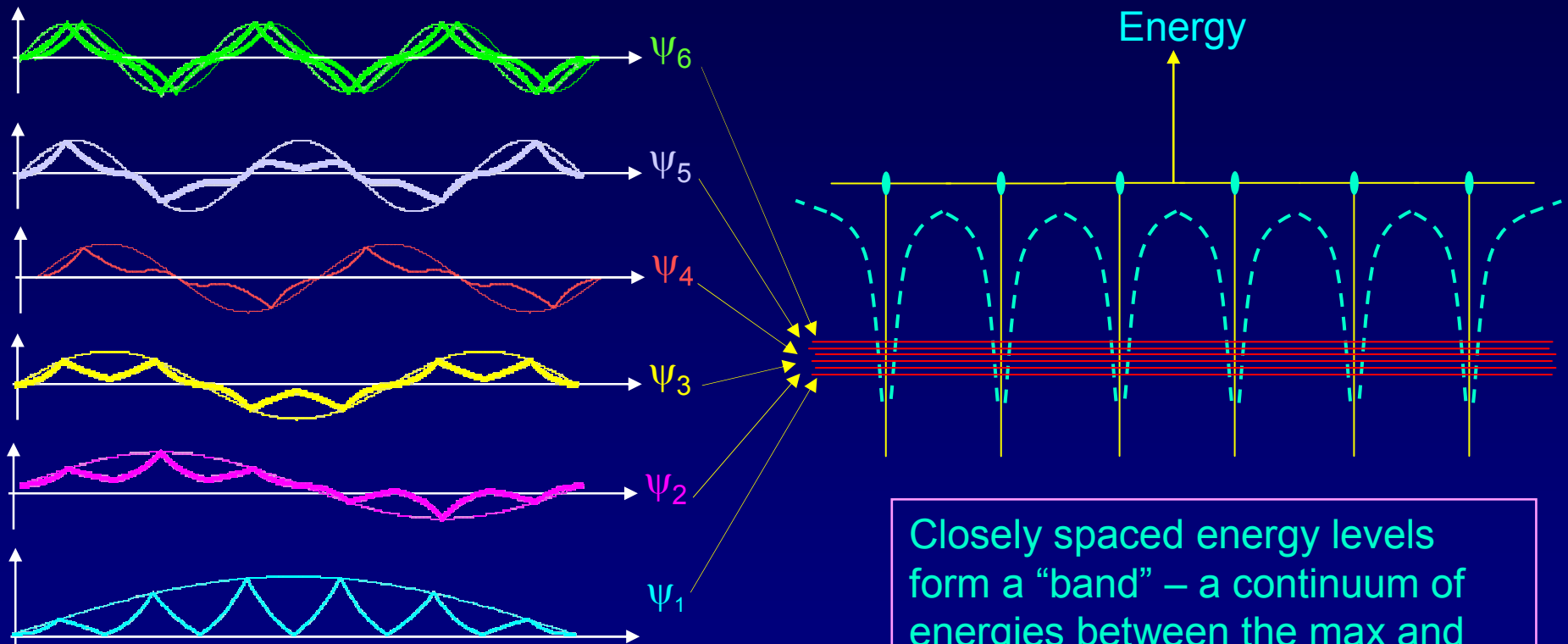

Lowest energy wave function

Closely spaced energy levels form a “band” – a continuum of energies between the max and min energies

FYI: These states are called “Bloch states” after Felix Bloch who derived the mathematical form in 1929. They can be written as:  $\psi_n(x) = u(x)e^{ik_n x}$  where  $u$  is an atomic-like function and the exponential is a convenient way to represent both sin and cos functions.

# Energy Bands and Band Gaps

In a crystal the number of atoms is very large and the states approach a continuum of energies between the lowest and highest → a “band” of energies. A band has exactly enough states to hold 2 electrons per atom (spin up and spin down).

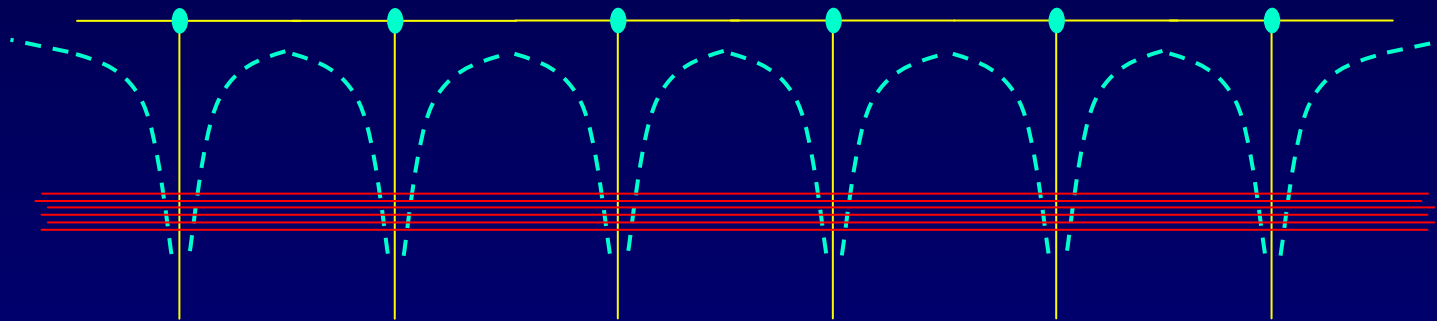

Each 1-atom state leads to an energy band. A crystal has multiple energy bands. **Band gaps** (regions of disallowed energies) lie between the bands.

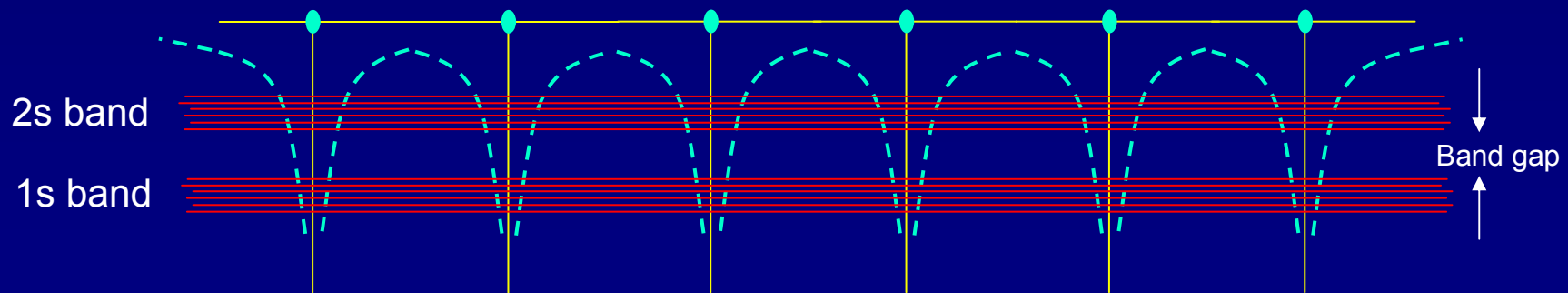

# Bands and Band Gaps Occur for all Types of Waves in Periodic Systems

Electron in a crystal – a periodic array of atoms

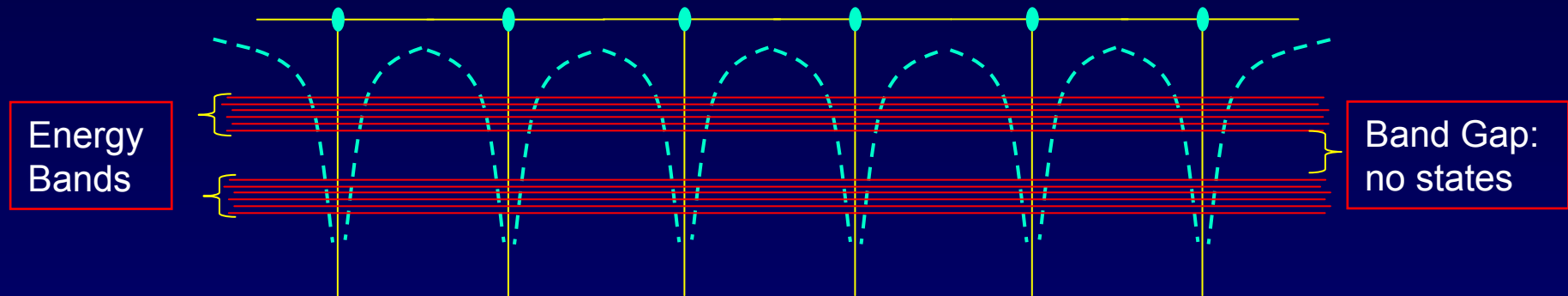

Light propagating through a periodic set of layers with different index of refraction – an interference filter

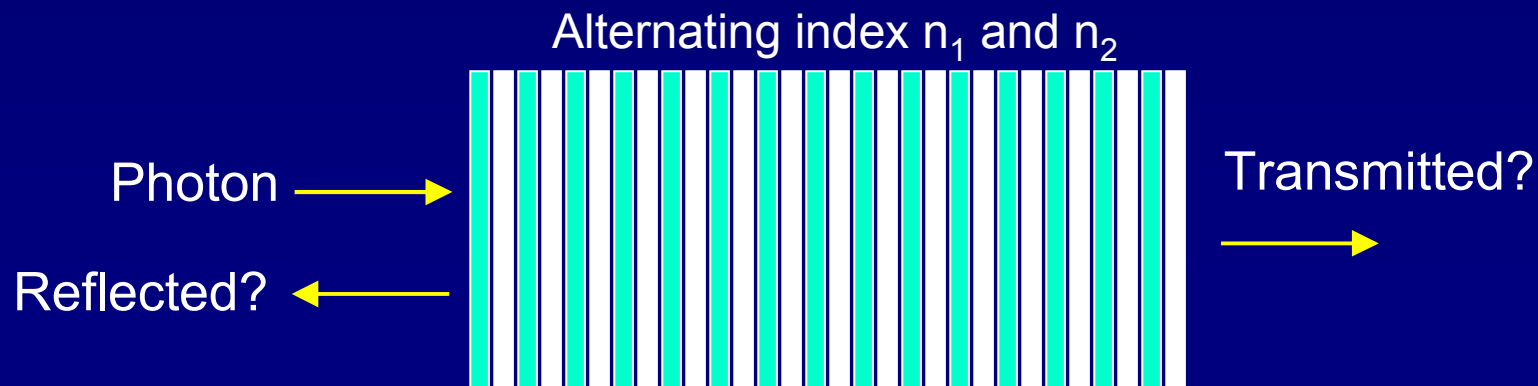

# Interference Filter

Light propagating through a periodic set of layers with alternating index of refraction.

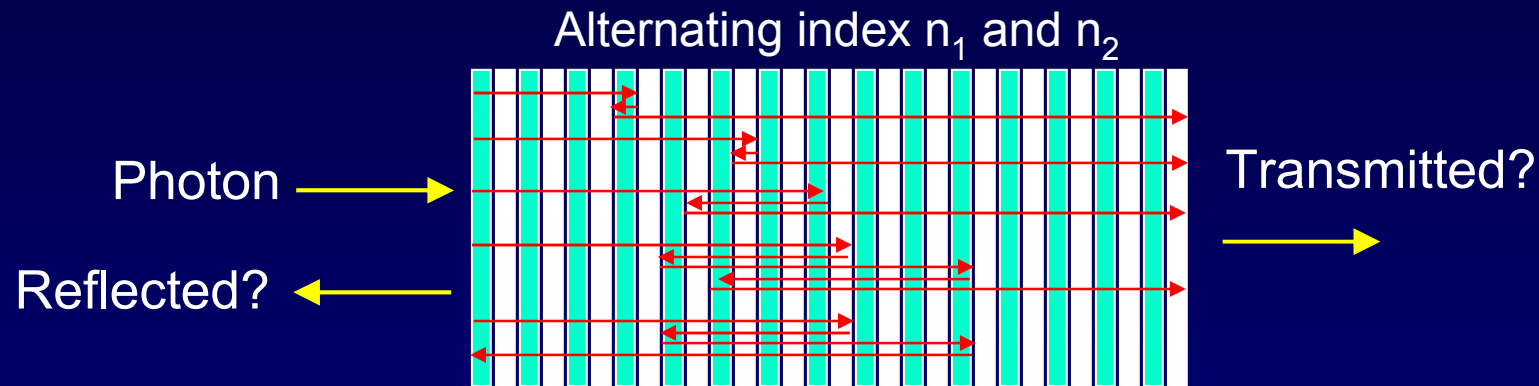

The behavior light waves in this material is the same as that of electron waves in a string of square wells.

For certain wavelengths there is complete reflection, because that wavelength cannot exist inside the material.

This is a “**stop band**”.

For other wavelengths there is complete transmission.

This is a “**pass band**”.



# Interference Filter

Conventional (dye) filters absorb unwanted colors.

Interference filters do not absorb light (do not get hot) and are used in many applications: TV, photography, astronomy, ...

Examples: Red, Green, Blue (RGB) → Yellow, Cyan, Magenta

What is magenta?

Answer: Magenta = Red + Blue (no Green)

A magenta filter must have a stop band in the green, but pass red and blue:

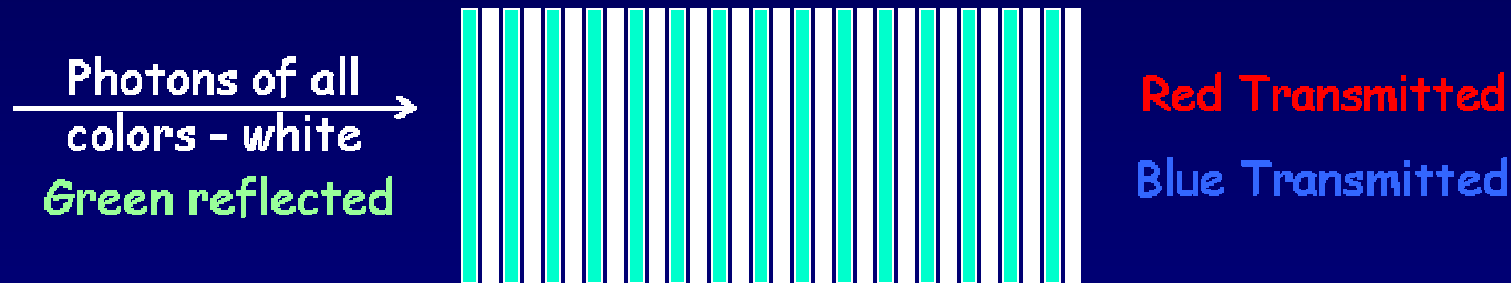

Demonstration with a commercial interference filter

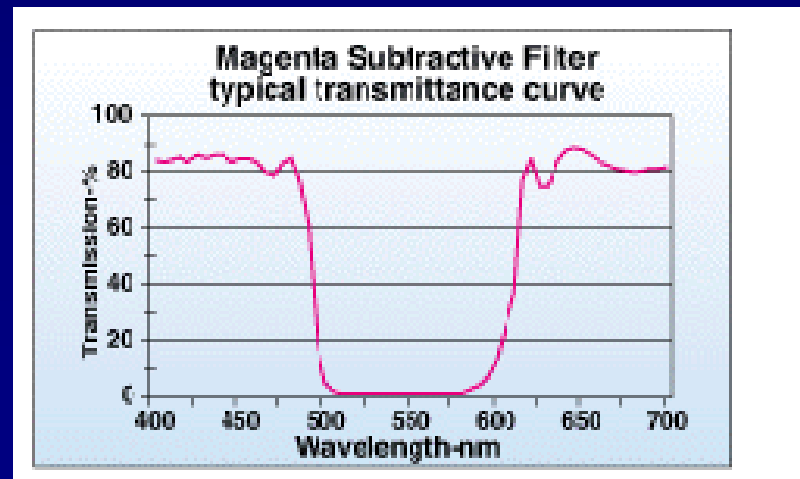

# Electrical Conductivity

The ability to conduct electricity varies enormously between different types of solids.

Resistivity  $\rho$  is defined by:  $J = \frac{I}{A} = \frac{1}{\rho} E$      $\rho = \frac{1}{\sigma} = \frac{m}{ne^2\tau}$

where  $J$  = current density and  $E$  = applied electric field.

Resistivity depends on the scattering time for electrons.

Resistivity depends on the number of free electrons.

Example properties at room temperature:

Material	Resistivity ( $\Omega\cdot\text{m}$ )	Carrier Density ( $\text{cm}^{-3}$ )	Type
Cu	$2 \times 10^{-8}$	$10^{23}$	conductor
Si	$3 \times 10^3$	$10^{10}$	semiconductor
Diamond	$2 \times 10^{16}$	small	insulator

# Why Some Solids Conduct Current and Others Don't

Conductors, semiconductors, and insulators:

Their description is provided in terms of:

- Energy Bands for electrons in solids
- The Pauli exclusion principle

In order for a material to conduct electricity, it must be possible to get the electrons moving (*i.e.*, give them some energy).

# Insulators, Semiconductors and Metals

Energy bands and the gaps between them determine the conductivity and other properties of solids.

## Insulators

Have a full valence band and a large energy gap (a few eV). Higher energy states are not available.

In order to conduct, an electron must have an available state at higher energy.

## Semiconductors

Are insulators at  $T = 0$ .  
Have a small energy gap ( $\sim 1$  eV) between valence and conduction bands. Higher energy states become available (due to  $kT$ ) as  $T$  increases.

## Metals

Have a partly filled band. Higher energy states are available, even at  $T = 0$ .

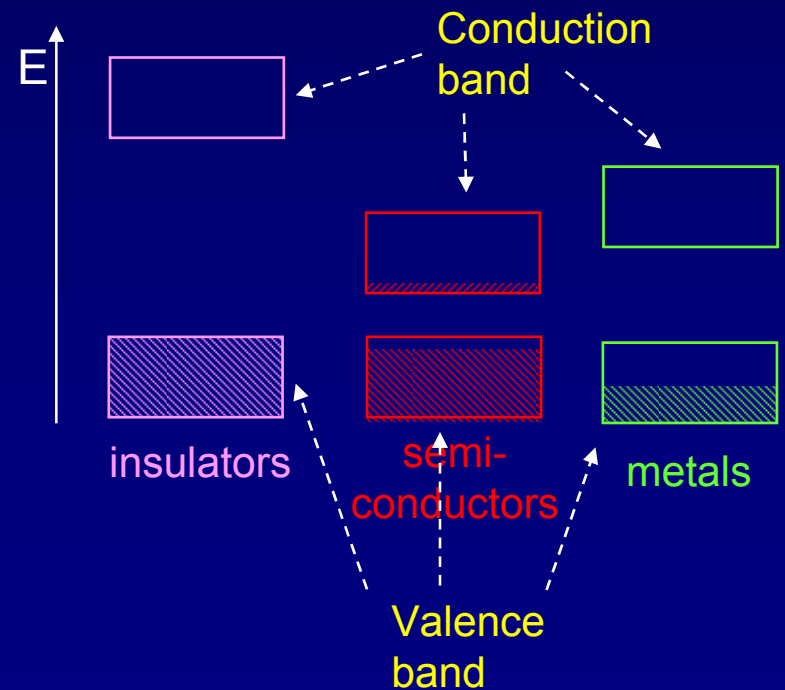

# Act 1

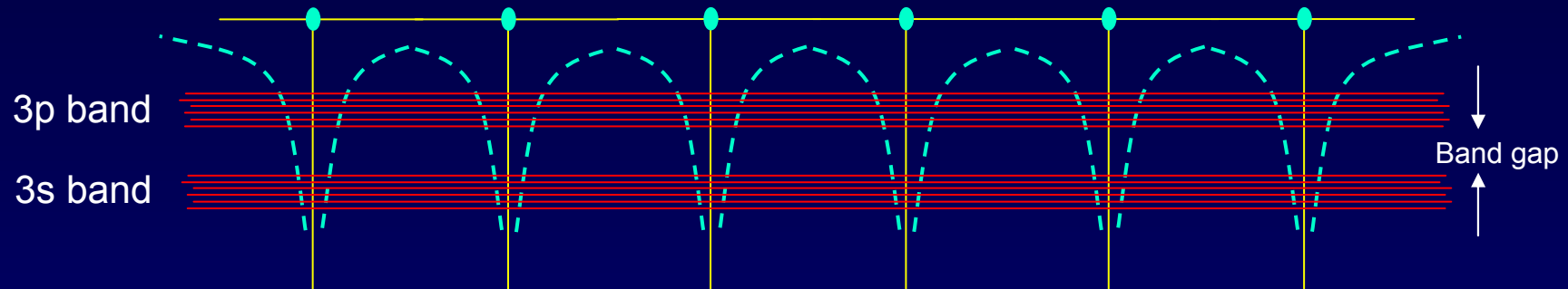

Consider a crystalline solid in which each atom contributes some electrons to the 3s band. Which situation can produce a conductor.

- Each atom contributes one 3s electron.
- Each atom contributes two 3s electrons.
- Each atom contributes three 3s electrons.

# Conductivity of Metals

Sodium:  $Z = 11$  ( $1s^2 2s^2 2p^6 3s^1$ )

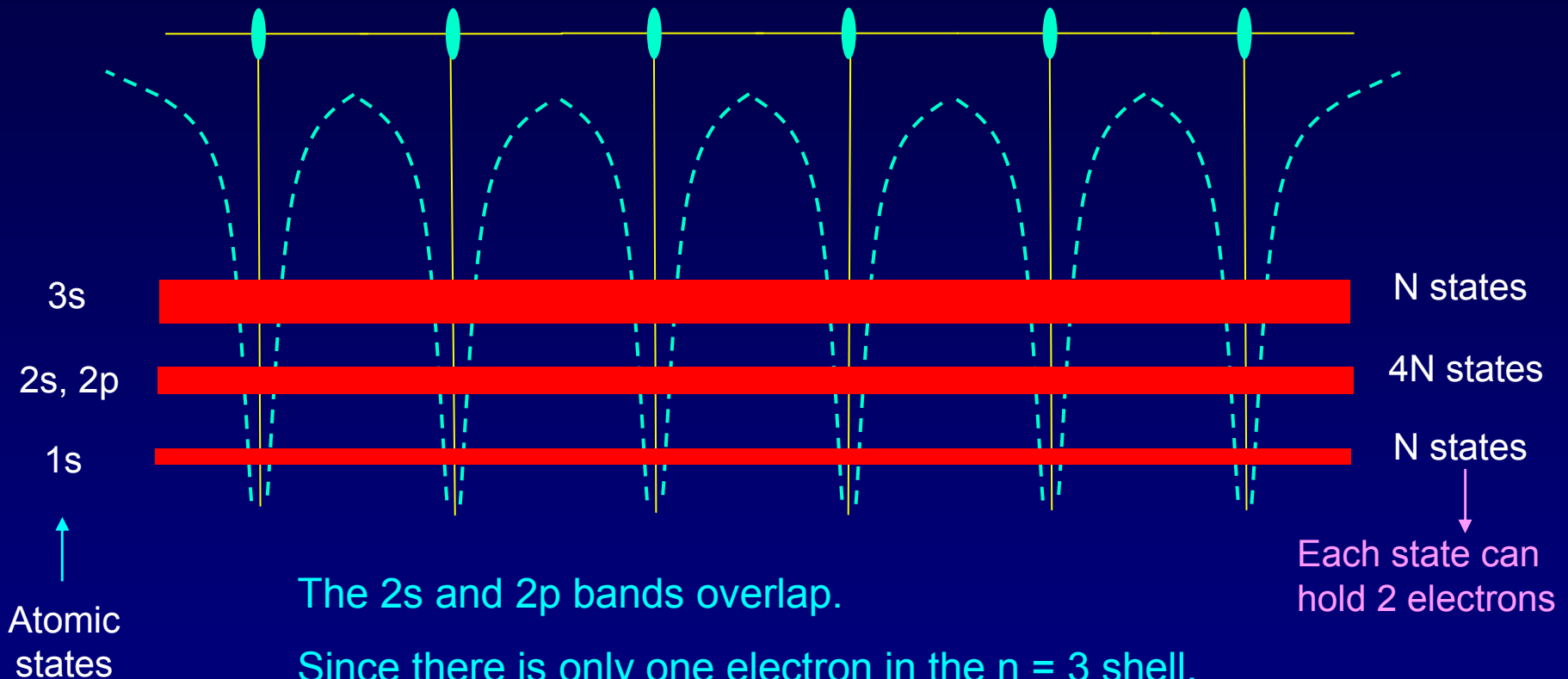

The 2s and 2p bands overlap.

Since there is only one electron in the  $n = 3$  shell, we don't need to consider the 3p or 3d bands, which partially overlap the 3s band.

Fill the bands with  $11N$  electrons.

# Conductivity of Metals

Sodium:  $Z = 11$  ( $1s^2 2s^2 2p^6 3s^1$ )

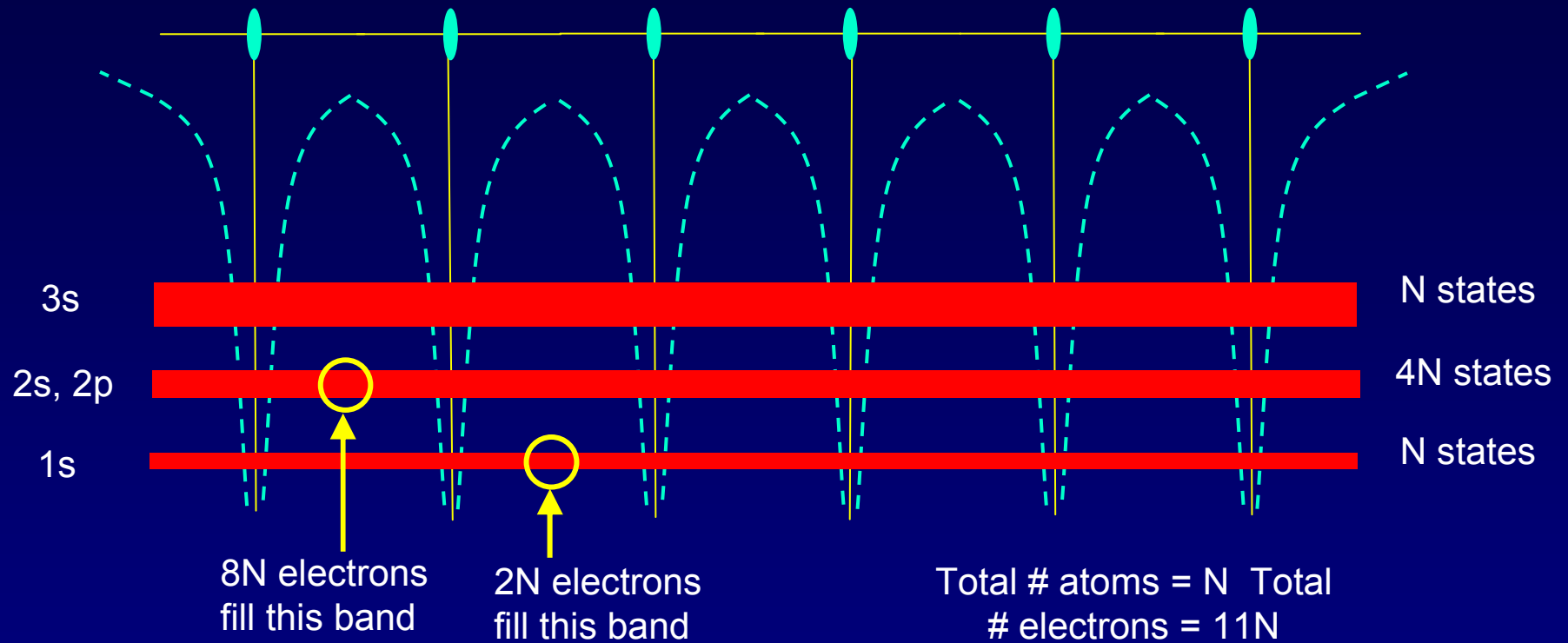

The 3s band is only half filled (N states and N electrons)

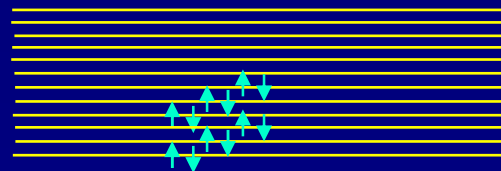

These electrons are easily promoted to higher states. Na is a good conductor.

Partially filled band → good conductor

# Solution

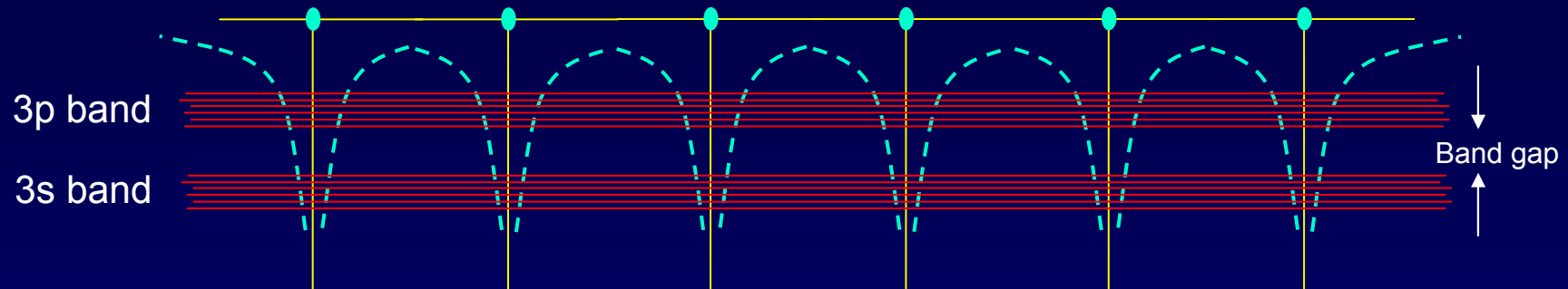

Consider a crystalline solid in which each atom contributes some electrons to the 3s band. Which situation can produce a conductor.

- a. Each atom contributes one 3s electron.
- b. Each atom contributes two 3s electrons.
- c. Each atom contributes three 3s electrons.

For  $N$  atoms, the band can hold  $2N$  electrons (spin up and spin down). So:

- a) gives us a half-filled band (conductor).
- b) gives a full band (insulator).
- c) is not possible. An atom can only have two 3s electrons.



# Semi-classical Picture of Conduction

Wire with cross section A

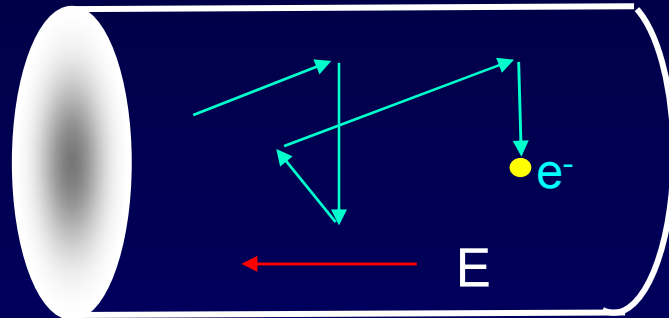

$n$  = # free electrons/volume  
 $\tau$  = time between scattering events  
 $J$  = current density =  $I/A$   
 $F$  = force =  $-eE$   
 $a$  = acceleration =  $F/m$

$$J = nev_{\text{drift}}$$

$$v_{\text{drift}} = a\tau = \frac{F}{m}\tau = \frac{eE}{m}\tau$$

$$J = \frac{ne^2\tau}{m}E = \sigma E, \text{ where}$$

$$\sigma \equiv \frac{ne^2\tau}{m} = \text{conductivity}$$

$$\rho = \frac{1}{\sigma} = \frac{m}{ne^2\tau}$$

Metal: scattering time gets shorter with increasing  $T$

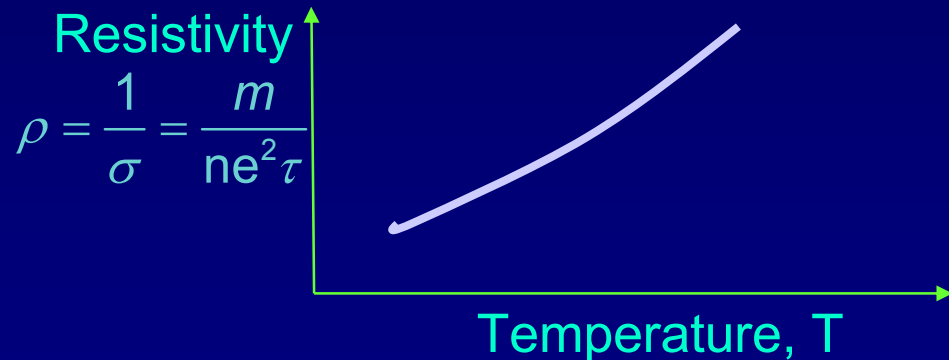

A more accurate description requires that we treat the electron as a quantum mechanical object.

# Superconductivity

1911: Kamerlingh-Onnes discovered that some metals at low temperature become perfect conductors. The resistance was lower than could be measured (still true today!).

1933: Meissner discovered that superconductors expel a magnetic field. They can be levitated by the magnetic repulsion.

The physics in a (small) nutshell:

At low temperatures, the electrons in some materials (e.g., lead) develop an energy gap (not the band gap). This gap makes it impossible for electrons to scatter from impurities, because no states are available.

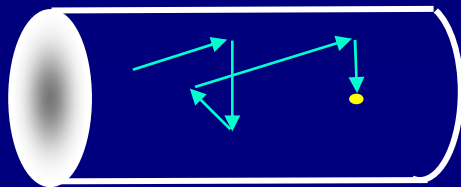

This does not happen in a superconductor.

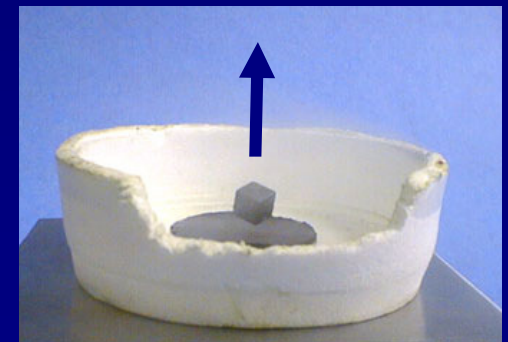
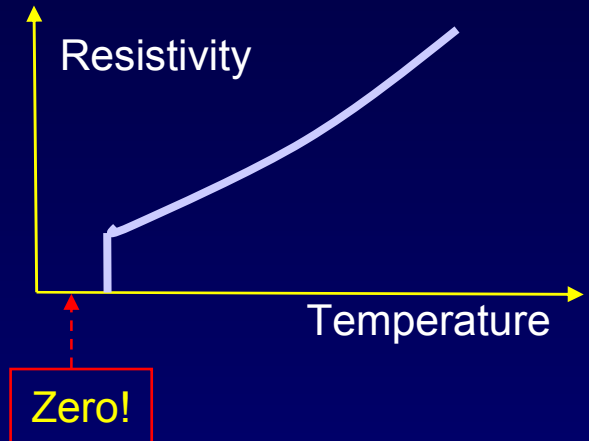

Demo

# Applications of Superconductivity

To date, applications have mostly been specialized. In particular, it is much cheaper to operate high field (high current) electromagnets if the wire is superconducting.

## MRI



## LHC accelerator



Superconducting Quantum Interference Devices (SQUIDs) are also used to make very sensitive magnetic field measurements (e.g., to make part in  $10^{12}$  measurements of magnetic susceptibility).

<http://rich.phekda.org/squid/technical/part4.html>



The holy grail of SC technology is electrical power distribution (7% is lost in the power grid). This is one reason  $HiT_c$  superconductors are important, but it's not yet competitive.

<http://www.nano-opt.jp/en/superconductor.html>

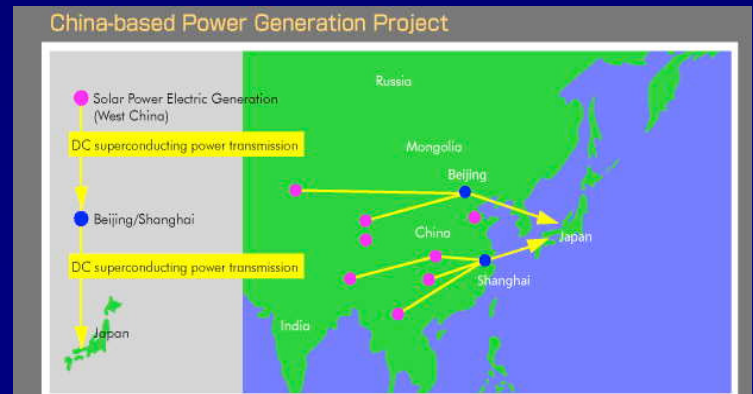

# Semiconductors

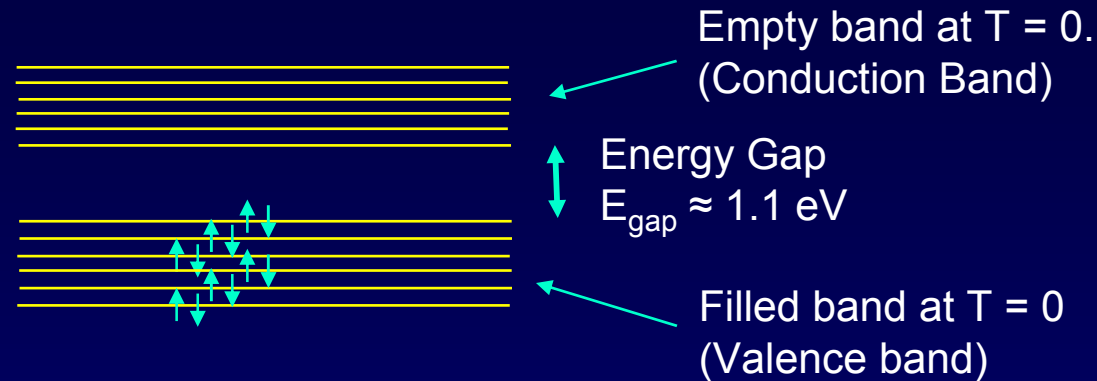

The electrons in a filled band cannot contribute to conduction, because with reasonable E fields they cannot be promoted to a higher kinetic energy. Therefore, at  $T = 0$ , pure semiconductors are actually insulators.

# Act 2

Consider electrons in a semiconductor, e.g., silicon. In a perfect crystal at  $T = 0$  the valence bands are filled and the conduction bands are empty  $\rightarrow$  no conduction. Which of the following could be done to make the material conductive?

- a. heat the material
- b. shine light on it
- c. add foreign atoms that change the number of electrons

# Solution

Consider electrons in a semiconductor, e.g., silicon. In a perfect crystal at  $T=0$  the valence bands are filled and the conduction bands are empty  $\Downarrow$  no conduction. Which of the following could be done to make the material conductive?

- a. heat the material
- b. shine light on it
- c. add foreign atoms that change the number of electrons

a and b: Both of these add energy to the material, exciting some of the electrons into the conduction band.

c: Adding foreign atoms (called “doping”) will either cause the material to have too many electrons to fit into the valence band (some will go into the conduction band), or cause the valence band to have unfilled states. In either case, some electrons will have nearby (in energy) states to which they can be excited.

# Semiconductors

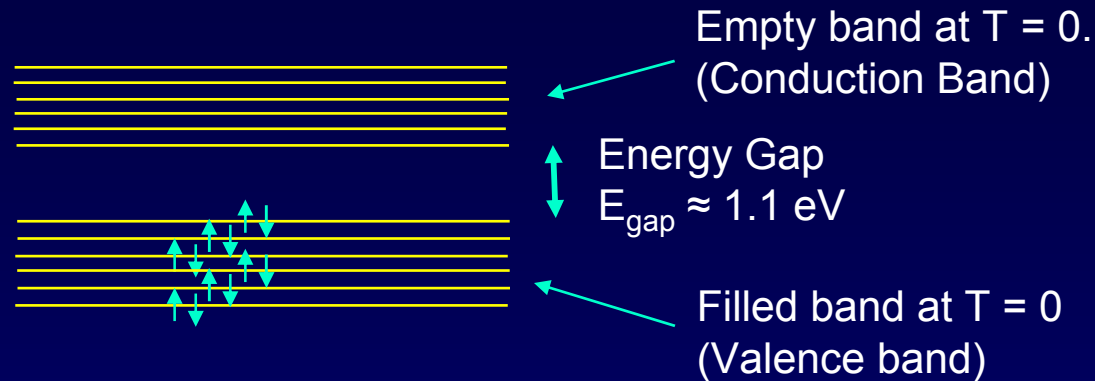

The electrons in a filled band cannot contribute to conduction, because with reasonable  $E$  fields they cannot be promoted to a higher kinetic energy. Therefore, at  $T = 0$ , pure semiconductors are actually insulators.

At higher temperatures, however, some electrons can be thermally promoted into the conduction band.

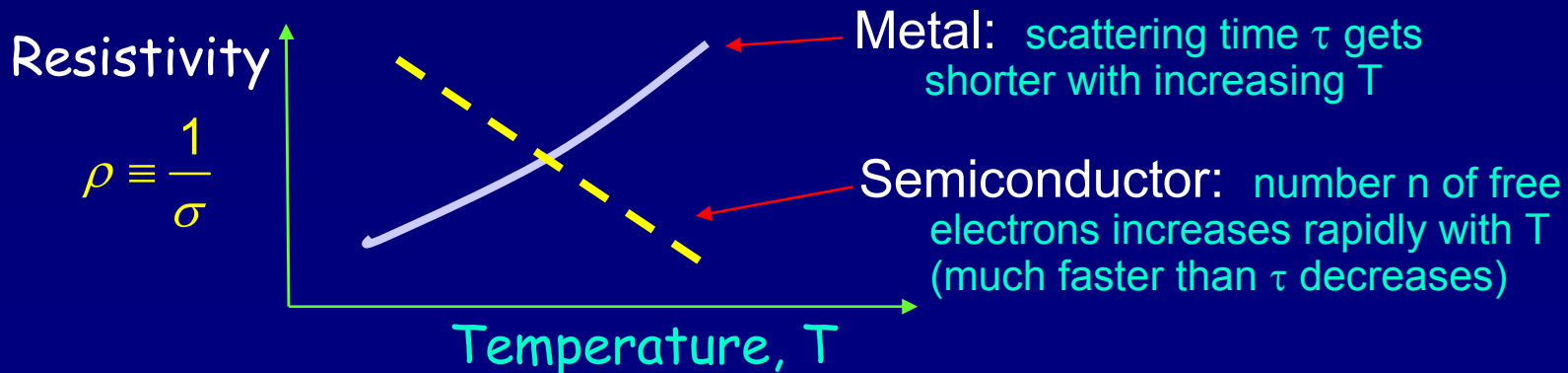

This graph only shows trends. A semiconductor has much higher resistance than a metal.

# Digital Thermometers

Digital thermometers use a **thermistor**, a semiconductor device that takes advantage of the exponential temperature dependence of a semiconductor's resistance. As the temperature increases, the resistance of the material drops markedly and can be used to determine the temperature.

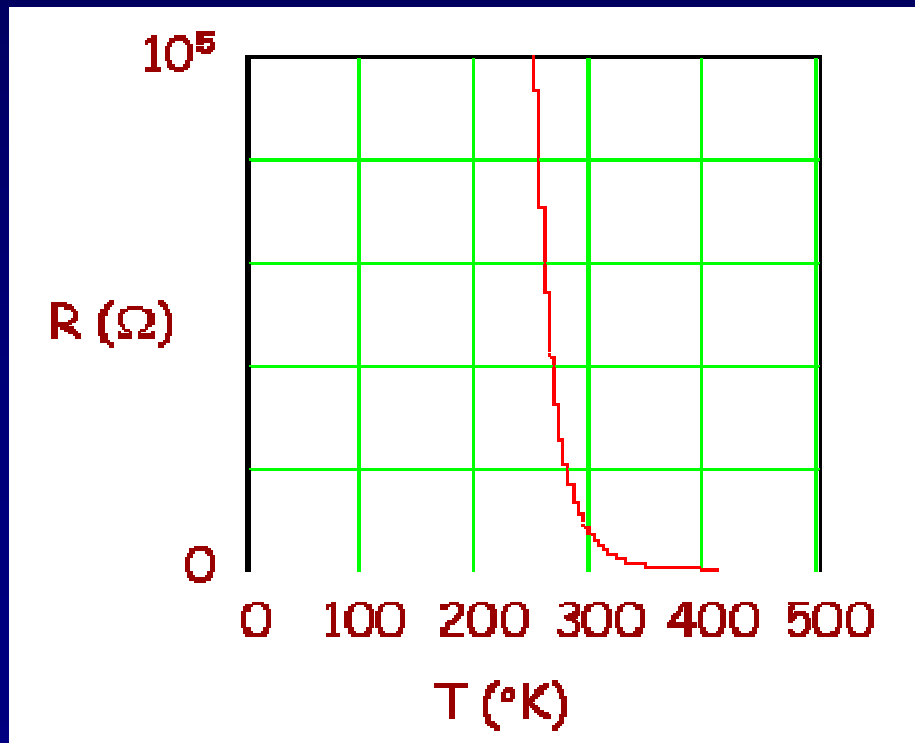



# Semiconductors

Silicon:  $Z = 14$  ( $1s^2 2s^2 2p^6 3s^2 3p^2$ )

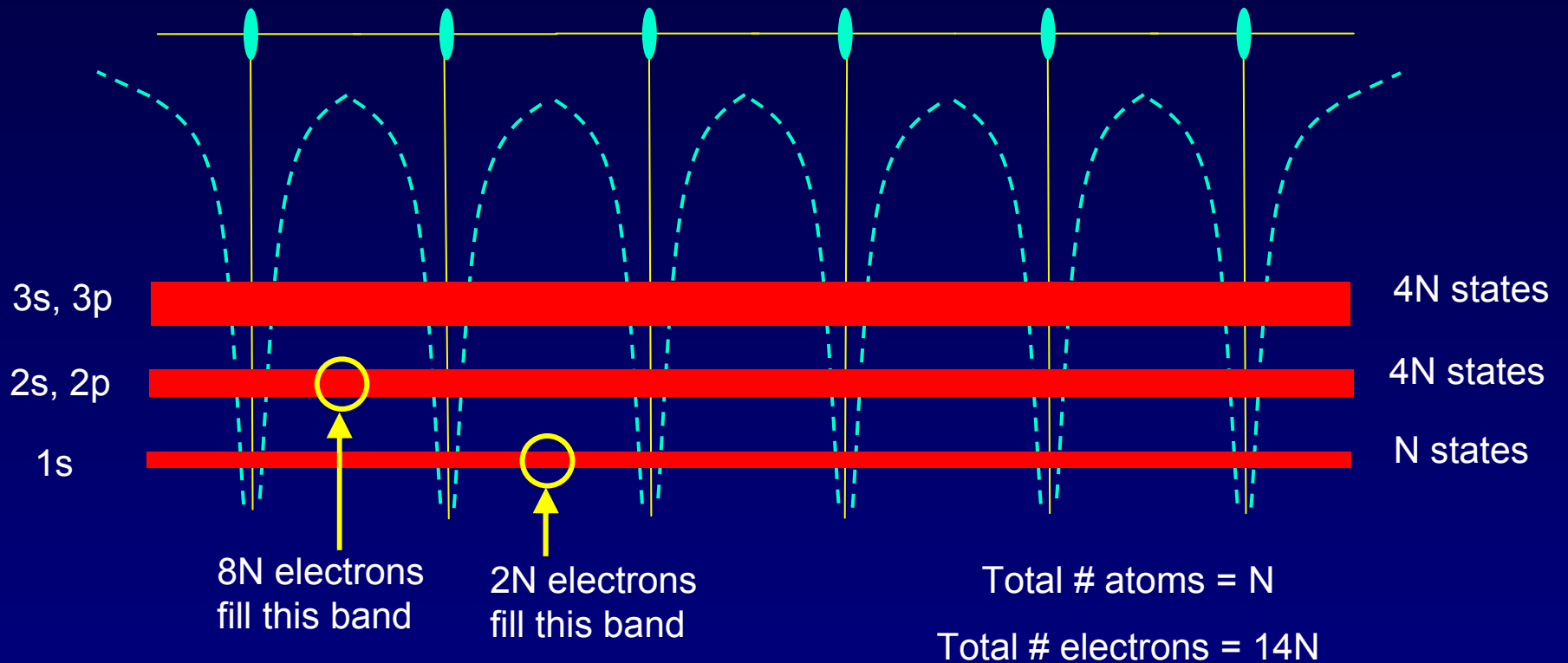

The 3s/3p band is only half filled (4N states and 4N electrons)

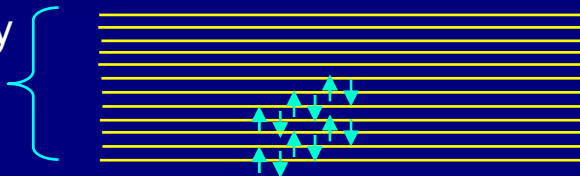

Why isn't Silicon a metallic conductor, like sodium?