

The Physics of Music & Musical Instruments



***“Music of the
Spheres”***

by

***Michail
Spiridonov,***

1997-98

Prof. Steven M. Errede, Department of Physics, UIUC, Urbana, IL

July 31, 2013

UIUC NSF REU POM Talk

1

Aside from having much fun & joy teaching POM/MI at UIUC for > past decade, in the process of doing this, many related questions of interest (to me) arose, for which I personally had no expertise, and hence initially had no answers for; nevertheless I was strongly motivated {driven?} to find/seek answers to them – I am after all, a physicist – we’re profoundly interested in understanding causal why/how relationships/connections...

I want to share & discuss with you – here, today some of these questions & {attempt to} present some answers to them – certainly by no means complete – I am also hoping to interest/motivate you to think about/delve into your own investigations of them – collectively, hopefully progress can be made on answering them!

Q1: Why is music seeming so universally important to our species? Seems to be genetically imprinted in us! How did this come about, & why did this happen? Have you ever met anyone who absolutely hates music?

Q2: Why/how is it possible to remember entire albums {cd’s} of music – even if we haven’t played them for decades, playing them back in “real-time” in our heads, hearing everything as clearly as if we are listening to them for real, when we can’t e.g. remember the names of people that we’ve been introduced to at a party, ~ 5 nsec after being introduced to them? Why is musical memory so strong, relative to “ordinary” memory? Music {somehow} must have been very important to our species in ancient times, since musical memories are so robust! Why is this? How did this happen?

Nature is economical/Nature “gilds no lilies” = smoking gun - points to importance of music in human evolution!

Q3: Why do we feel “better” after listening to or better yet, actively playing music, or e.g. going to Sunday school/church & singing songs/hymns?

Q4: Our species is unique amongst the totality of life forms on this planet. We’re the only ones who, apparently are driven to learn/understand the universe in which we live, enabled us to master/control our environment...

⇒ Did music {somehow} play an important role in enabling/facilitating us to get to where we are today?

Or is human music just “auditory cheesecake” e.g. as *Steven Pinker* (1997) suggests...

Q5: If intelligent life exists elsewhere in the universe, would those life-forms also have music? If so, what would their music sound like? Did their music also play a role in that life-form’s development?

Why do humans **like** music?
Is music **just** “auditory cheesecake” ??

a, in ancient times.. (“t = 0” ~ 200
Kyrs ago, or perhaps even earlier..)

For **any** human
attribute, **a**:

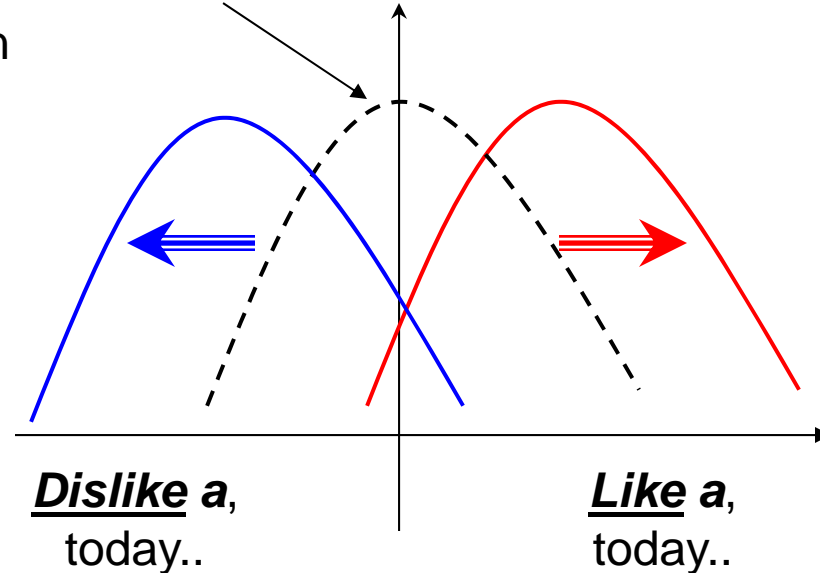

Did evolutionary “forces” – “survival of the fittest” shift (via feedback mechanisms / genetic mutations over the millennia) each generic human attribute **a** from initial $\langle a \rangle = 0$ to where it is today?

A (Very) Brief History of Planet Earth:

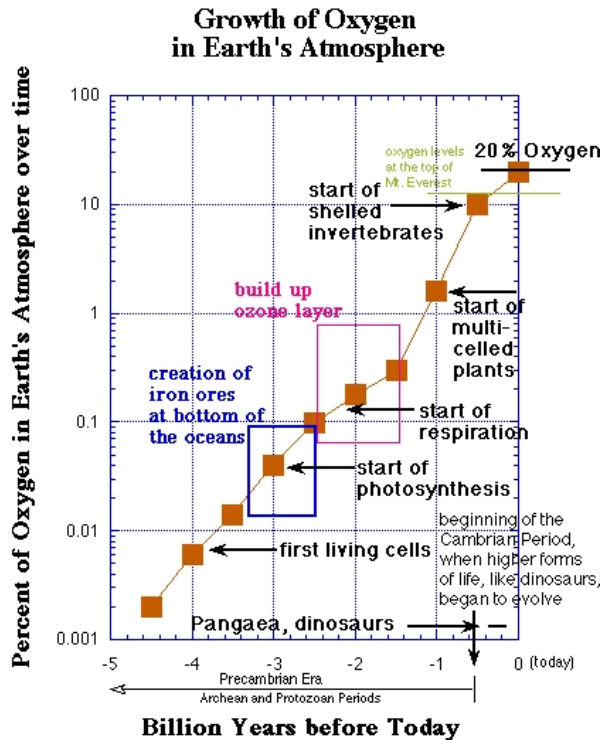

The earth's magnetic field (due to internal dynamo earth's outer core) shields planet from deadly solar X- & γ -radiation:

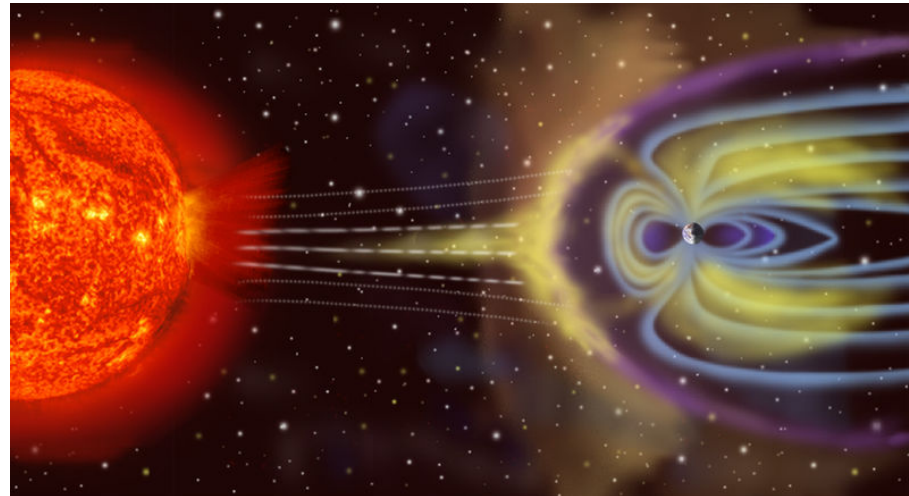

Photosynthesis of cyano-bacteria living in earth's oceans initially drove oxygenation of earth's atmosphere.

Further oxygenation of earth's atmosphere by stromatolites:



- ~ 4.5 Byrs ago: Solar System forms
- ~ 4.0 Byrs ago: late heavy bombardment in solar system ends;
The earth is in the "habitable zone", cools and {single-celled} life begins...
- ~ 3.5 Byrs ago: photosynthesis begins
- ~ 2.3 Byrs ago: earth's atmosphere becomes oxygen rich;
The first "snowball earth" occurs... but eventually warms up again...
Ozone layer forms at the top of earth's atmosphere, enabling life to exist on land
– shielding it from harmful UV radiation.

**Breakup & formation of continents on earth – plate tectonics – appears to be cyclical;
Pangaea – last supercontinent in the Permian epoch (~ 225 Myrs ago):**

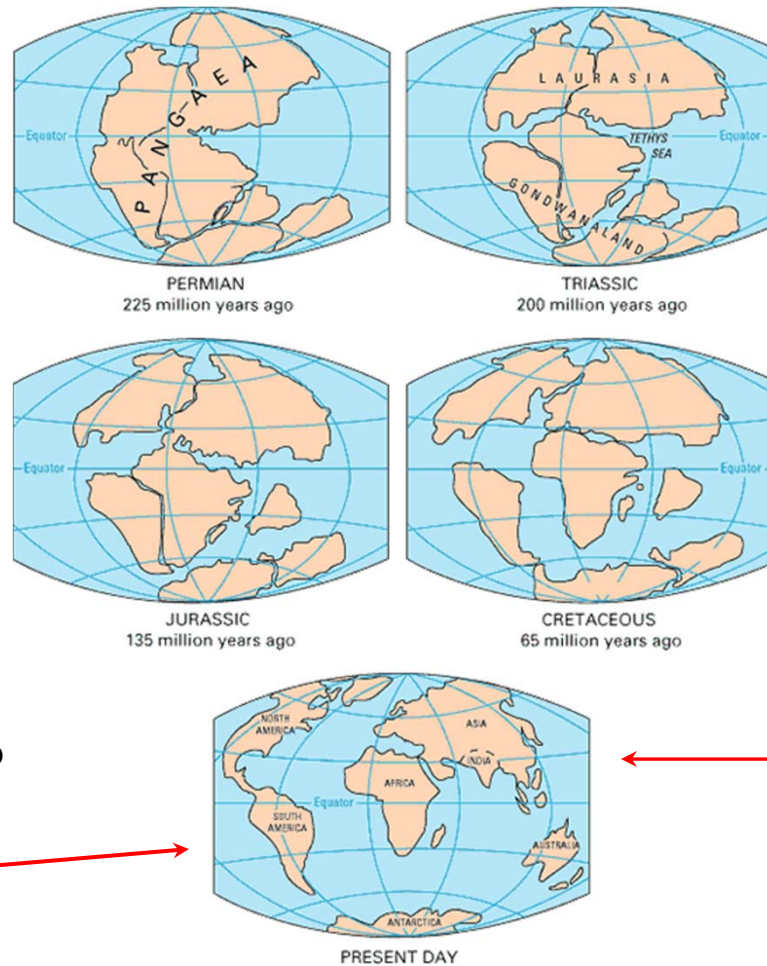

Heat convection (due to planet's original formation & radioactive decay) inside the earth, breaks up Pangaea into 7 major parts – the continents – drift apart, such that today we have:

Next Pangaea located at the north pole??

Life on our planet is ***totally*** dependent on {the constancy of} the four fundamental forces of nature that are operative in the universe in which we live:

- o **Weak Force**: Responsible for radioactivity (β -decay) – our sun’s source of power generation!
- o **Strong Force**: Binds protons & neutrons together to form nuclei (also important for solar processes!)
- o **Electromagnetic Force**: Binds nuclei and electrons together to form atoms, atom-atom interactions (molecules, all chemical reactions, electromagnetic & acoustic wave phenomena...)
- o **Gravity** (curvature of space-time): Binds atoms together to form stars, solar systems/planets, galaxies, ...

Gedanken experiment # 1:

Turn any one force completely ***off*** (i.e. coupling constant $\rightarrow 0$): Life as we know it cannot exist/survive!

Gedanken experiment # 2:

Change the ***strength*** of any one interaction (e.g. gravity, or charge) – life as we know it radically changes!

Gravity on the moon:



$$g = g_{moon}$$

Gravity on Earth:



$$g = g_{\oplus}$$

Remodeling effects of our {piezo-electric} bones!

Gravity on Jupiter:



$$g = g_{J}$$

Gravity in 11 Dimensions:



$$g = g^{i\pi/N_{dim}}$$

Life on our planet is shaped by the fundamental laws of physics operative in our universe:

We live in 4-D space-time (3 spatial dimensions + 1 time dimension) – skeleton of bones + muscles enables locomotion in space-time – evolutionarily very beneficial for our survival – for finding food {& avoiding becoming food...}

We have developed a sense of the rate of passage of time – involves basal ganglia (deep within base of brain), cerebellum & parietal lobe (on surface of right side of our brains) critical areas for this time-keeping mechanism.

We have 3-D stereoscopic accelerometer/inertial guidance system {Newton's 2nd law $F = ma$ } – pair of semicircular canals for orientation {and maintaining our balance - helps us avoid injury/death} in space. Gravitational acceleration g exists on our planet, tells us what up vs. down is...

EM radiation {from our Sun} exists – we have stereoscopic pair of eyes {sensitive to visible light portion of EM radiation spectrum} to navigate in/around/interact with our environment day/night to find food/avoid becoming food...

We live in a medium {air/water} which supports propagation of acoustic waves – we have stereoscopic pair of ears which enables us to hear sounds in our environment – helps us navigate in/around/interact with our environment day/night to find food/avoid becoming food...

We have vocal chords – mechanism for producing sound – helps us communicate with/find others of our species – evolutionarily very beneficial for our survival {we're a social species of animal}, group hunting for food/avoiding becoming food...

We have senses of taste & smell – tell us which food(s) are good/safe to eat, which food(s) are not good/safe to eat... n.b. wired into our emotional centers... Sense of smell also useful for finding food/avoid becoming food...

Skin (our largest organ) contains nerves – for sense of touch, pain & thermo-receptors – to help us avoid damage/injury to our bodies/death...

Nature makes amazing very effective/economical use of many physics processes operative in our world:

Some animals see in UV and IR portions of the EM radiation spectrum, some animals have 4-color vision...

Sunlight from sky is partially polarized by Rayleigh scattering – vision in some animals (birds & fish) make use of polarized light – e.g. for navigation and/or finding food...

Some animals glow in the dark - i.e. emit visible light! Some animals can dramatically change colors (have chromophores)!

Some {deep-sea} life-forms based on sulfur chemistry, instead of carbon-based!

⊃ Anerobic bacteria living in soil/rock of our planet – to depths 100's -1000's of meters below surface of earth!

Some animals sensitive to electric and/or magnetic fields. Fish/sharks sensitive to E-fields – useful for finding food. Electric eels/rays stun prey; birds use B-field of earth for navigation, –ve ions in air (earth's E-field electrode layer @ surface of earth) important for plants (& animals)...

Some animals use infrasound {e.g. communication} and/or ultrasound {communication & sonar – for finding food}. Some insects (e.g. grasshoppers) utilize vector particle velocity \vec{u} instead of scalar pressure p for hearing!

Earth's diurnal rotation – circadian rhythms in living creatures; Some birds (e.g. indigo bunting) use Polaris (North star) for navigation/migration!

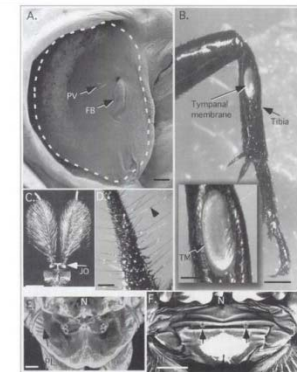
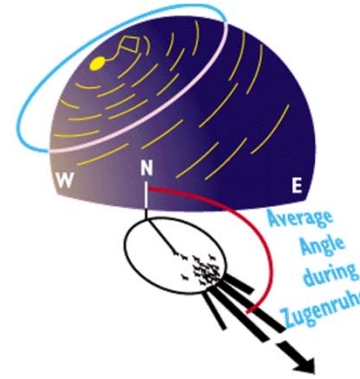
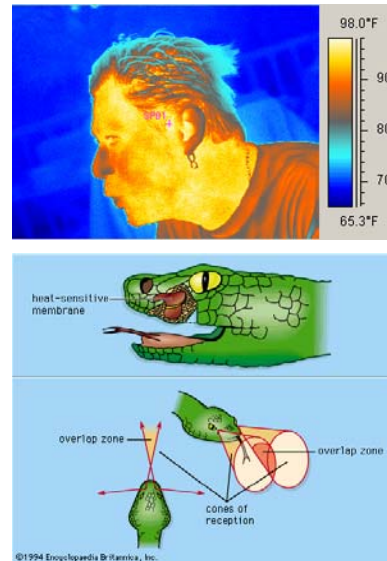

FIGURE 2.1. External auditory anatomy of a locust, a cricket, a mosquito, the cercal system of the cricket, and two parasitoid flies. (A) The tympanal ear of the locust. PV is the pyriform vesicle; FB the folded body to which high and low-frequency receptors respectively attach. The tympanal membrane is delineated by the white-stippled line. Scale bar = 200 μ m. (B) Posterior tympanum on the tibia of the first pair of legs of the cricket *Gryllus bimaculatus*. Scale bar = 1 mm (inset: 250 μ m). (C) Light scanning micrograph of the antennae of the male mosquito *Anopheles tritaeniorhynchus*. The bell-like structures at the base of the antenna are the mechanoreceptive organs. Scale bar = 500 μ m. (D) Filiform hairs on the cercus of the field cricket *G. bimaculatus*. Scale bar = 200 μ m. (E) Tympanal ear of a tachinid fly (*Oreona*). Arrow, tympanal membrane; *serena-head*, insertion point of the mechanoreceptive organ; N, neck; PL, peritrophic leg. Scale bar = 200 μ m. (Light scanning micrograph by D. Huber). (F) Tympanal ear of a sarcophagid fly (*Eubolbosoma*). Arrows show insertion points of mechanoreceptive organs on the tympanal fold. Scale bar = 200 μ m.

Simply astounding !!!
 ⇒ Important for recognizing / detecting life-forms elsewhere in universe?

Human vision in visible light region no accident:

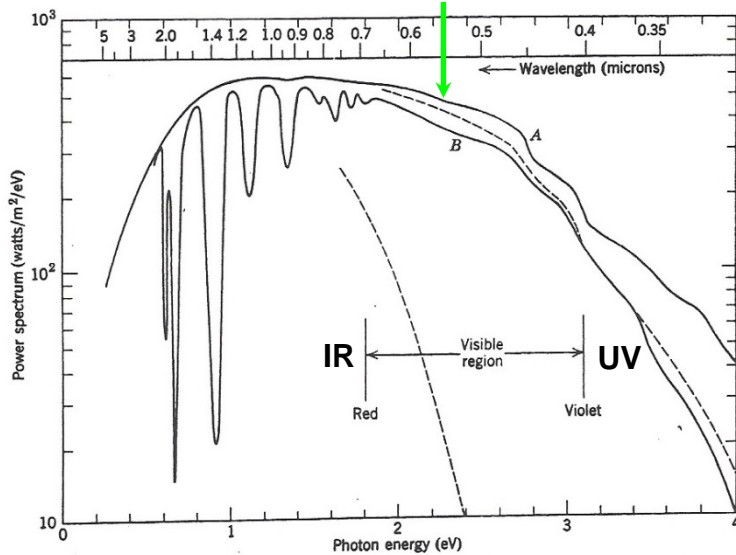
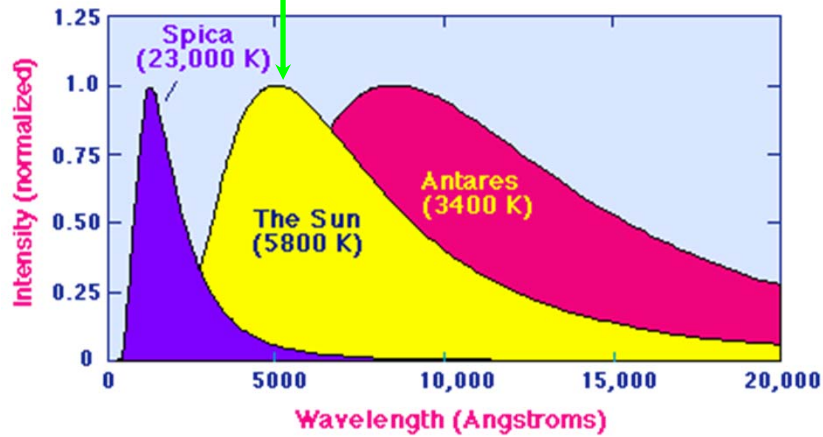
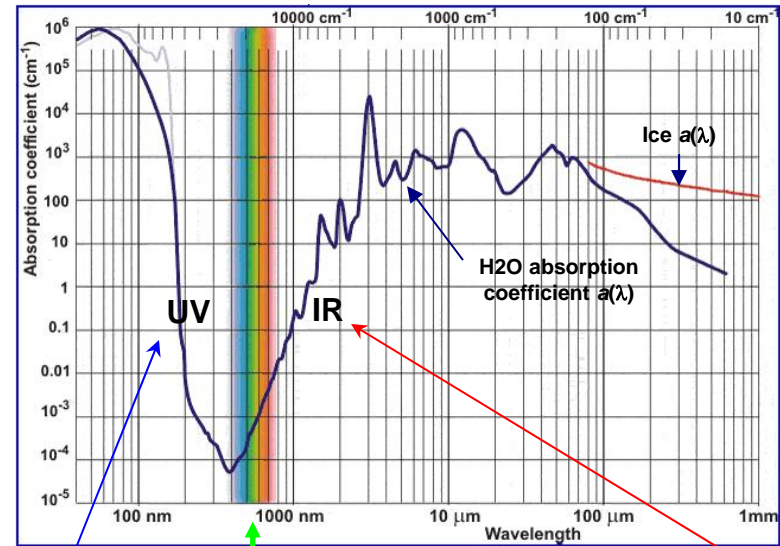
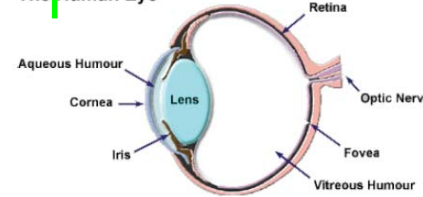

Figure 10.4 Power spectrum of solar radiation (in watts per square meter per electron volt) as a function of photon energy (in electron volts). Curve A is the incident spectrum above the atmosphere. Curve B is a typical sea-level spectrum with the sun at the zenith. The absorption bands below 2 eV are chiefly from water vapor and vary from site to site and day to day. The dashed curves give the expected sea-level spectrum at zenith and at sunrise-sunset if the only attenuation is from Rayleigh scattering by a dry, clean atmosphere.



UV photons damage human cells...

The Human Eye



We're warm-blooded animals – wouldn't want to be sensitive to our own black-body/IR radiation – wouldn't be able to sleep at night!

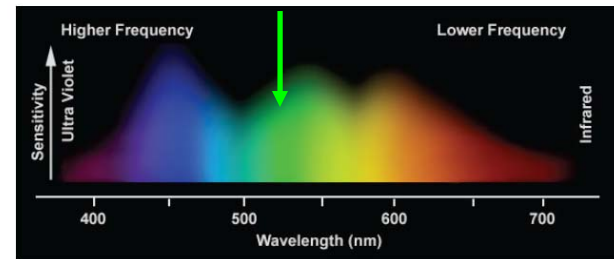

Typical spectral response of human eye

The {Vast} Tree of Life on Planet Earth:

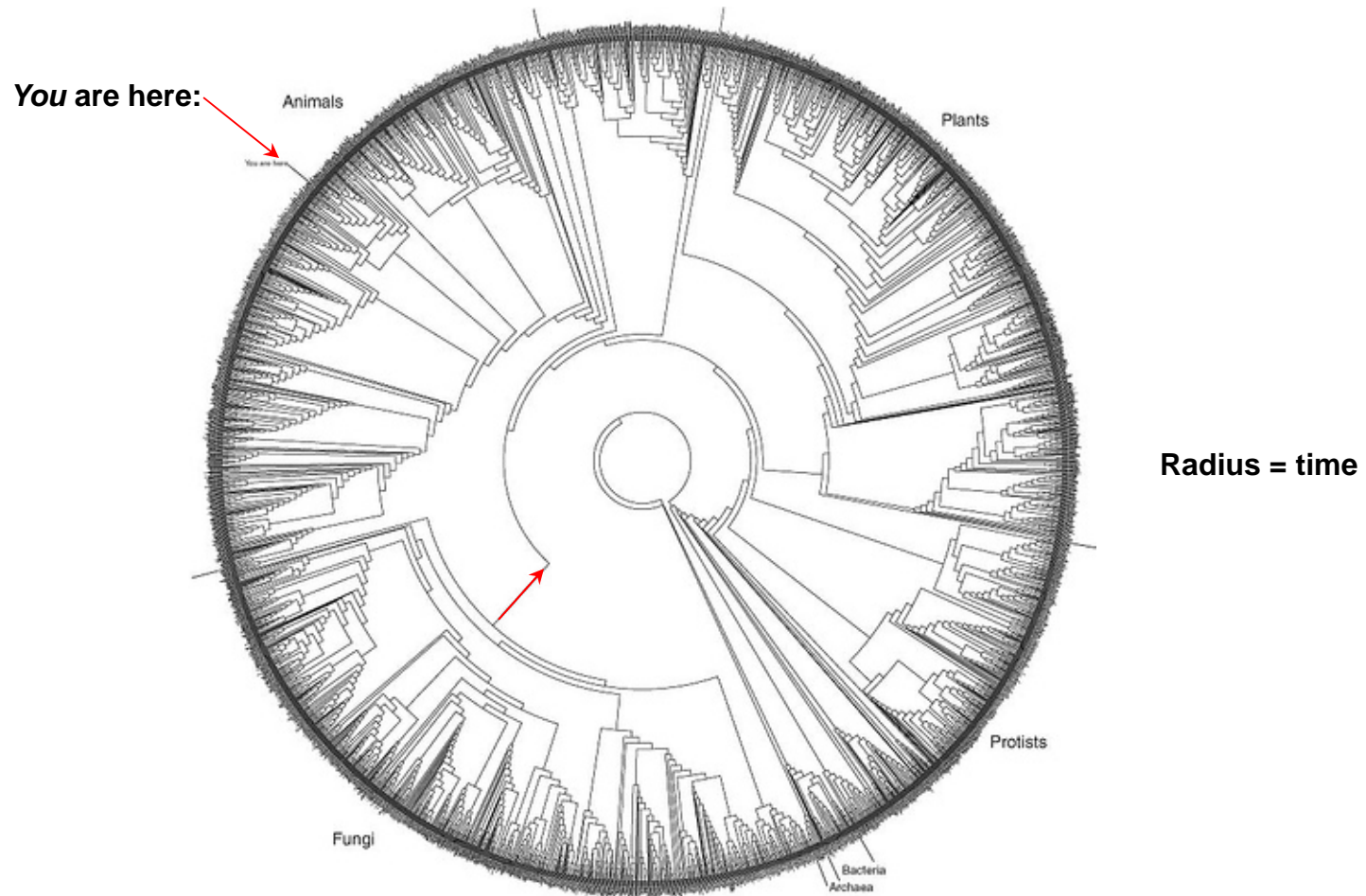

⇒ We're {distantly} related to mold – eek !!!

The Human Tree of Life:

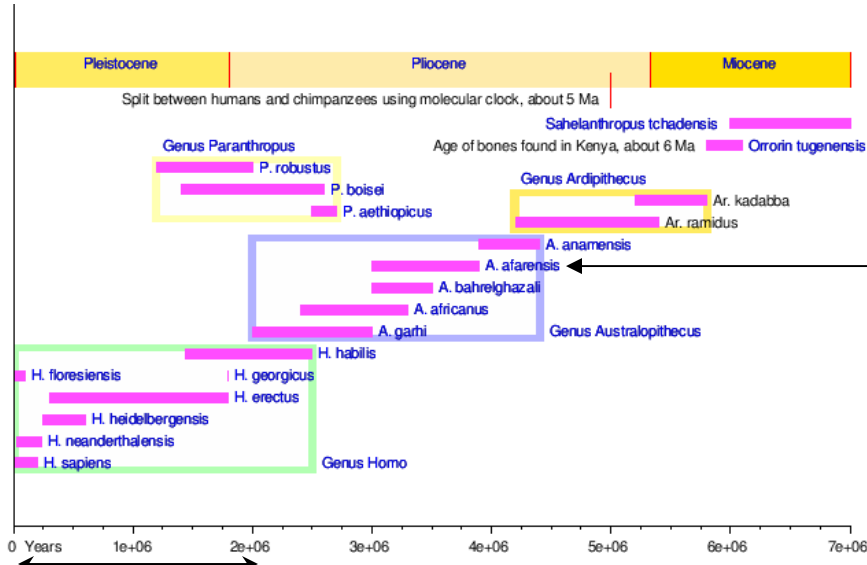

Australopithecus afarensis (2.9-3.9 Myr ago) – had developed bipedalism, but lacked the large brain that modern humans have today

Spreading of Homo sapiens as hunter-gatherers with time: Driven by climate change???

Homo sapiens originated in East Africa ~ 200,000 years ago

⇒ We're literally the "new kids on the block", from a geological perspective!

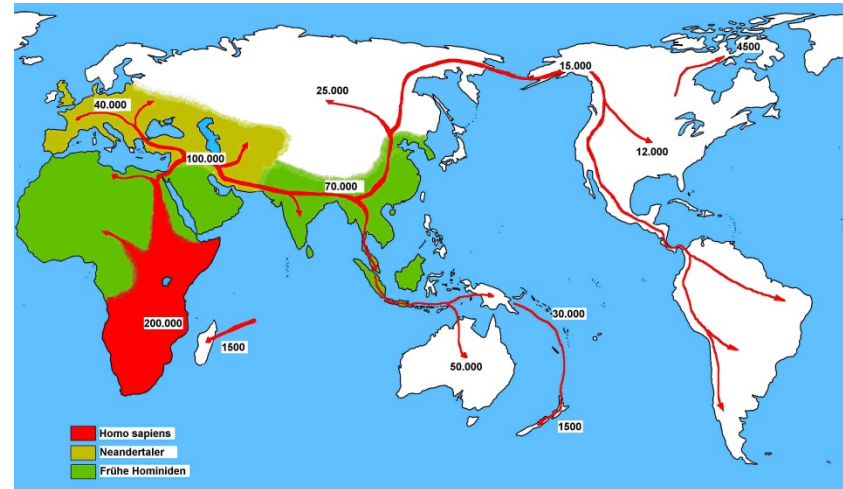
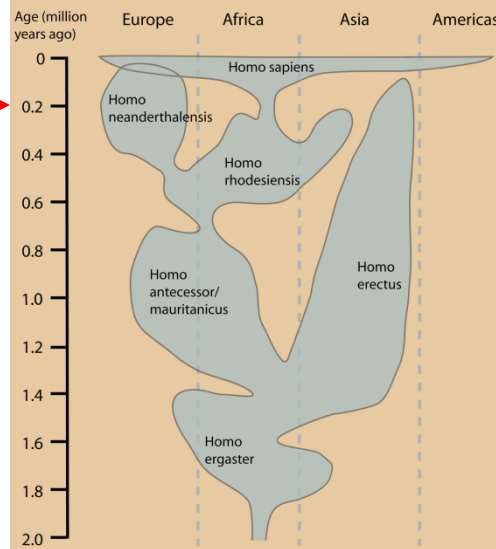

Evolution of Homo Sapiens As Relevant to the Development of Human Language & Music:

- Our (hairy) ancient ancestors in Africa {n.b. social creatures!} came down out of the trees – began living on the ground – as hunter-gatherers – driven by climate change???
- We began walking **upright**... evolutionarily advantageous/beneficial adaptation for life on the savannah...
- However, it's **much** hotter living on the ground than in the trees!!! Have to **pant** in order to cool off! ⇒ We developed sweat glands, and lost much/nearly all of our body hair...
- If have little/no body hair, + sweat glands ⇒ now we don't have to **pant** to cool off !!!
- If don't have to **pant**, this opens up possibilities for evolutionarily beneficial changes to the **human voice box** – facilitates better communication amongst members of a human social group – e.g. collaborative/collective hunting, etc...
- Humans today have a sophisticated voice box + hyoid bone – lower-positioned voice box works in unison w/ larynx and tongue – enables **rich** complexity/versatility in producing vocal sounds – e.g. vowels & consonants, and singing!
- Hyoid bone developed ~ 300 Kyrs ago (Homo heidelbergensis)...
- ⇒ Facilitated development of a more sophisticated language...
- ⇒ Facilitated development of music – human voice = **the** 1st musical instrument!

The Human Voice – The first / earliest musical instrument... unique to each human!

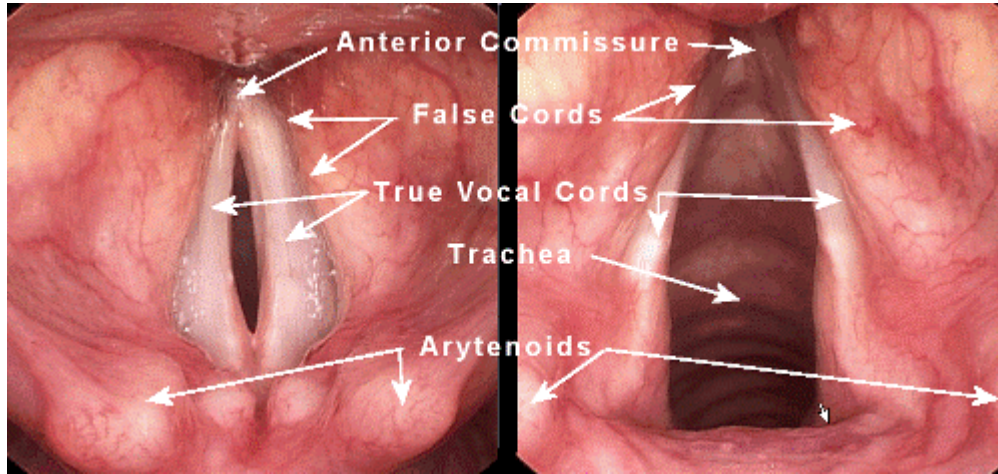

When singing (& talking), the human vocal cords vibrate as a 1-D system (e.g. like a guitar string) – production of integer related harmonics of fundamental:

$$f_n = n f_1 \quad n = 1, 2, 3, \dots$$

n.b. If we instead had e.g. a 2-D circular membrane for producing musical sounds, would not have such a relation:

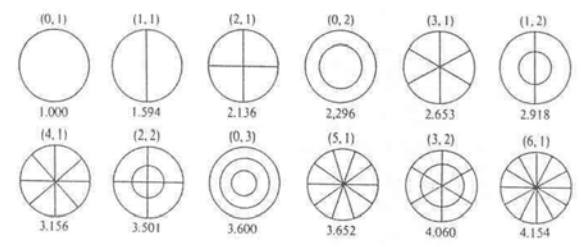
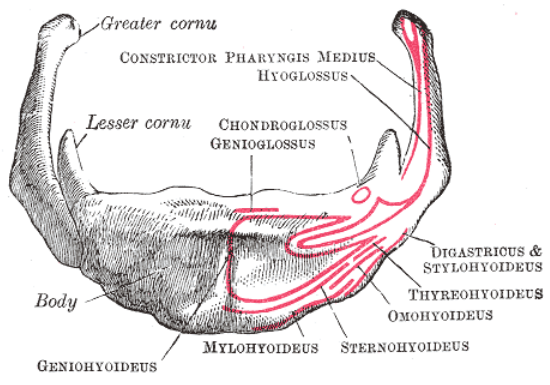

FIGURE 3.6. First 14 modes of an ideal membrane. The mode designation (m, n) is given above each figure and the relative frequency below. To convert these to actual frequencies, multiply by $(2.405/2\pi a)\sqrt{T/\sigma}$, where a is the membrane radius.

$$\nabla^2 \psi = \frac{1}{c^2} \partial^2 \psi / \partial t^2$$

$$f_{lmn}^{3D} \propto \sqrt{\alpha l^2 + \beta m^2 + \gamma n^2}$$

This mathematical physics fact has important / profound consequences for the development of music and musical instruments by humans....



The hyoid bone (present in many mammals) is unique to Homo sapiens – enables production of a wide range of sounds that other animals cannot produce – allowing wider range of the tongue, pharyngeal and laryngeal movements – necessary for human speech (and song)...

Human Hearing:

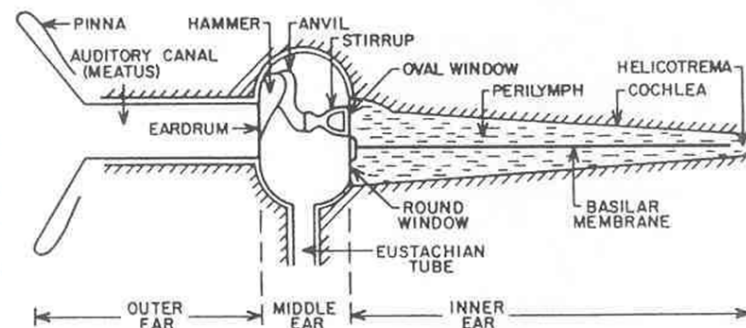
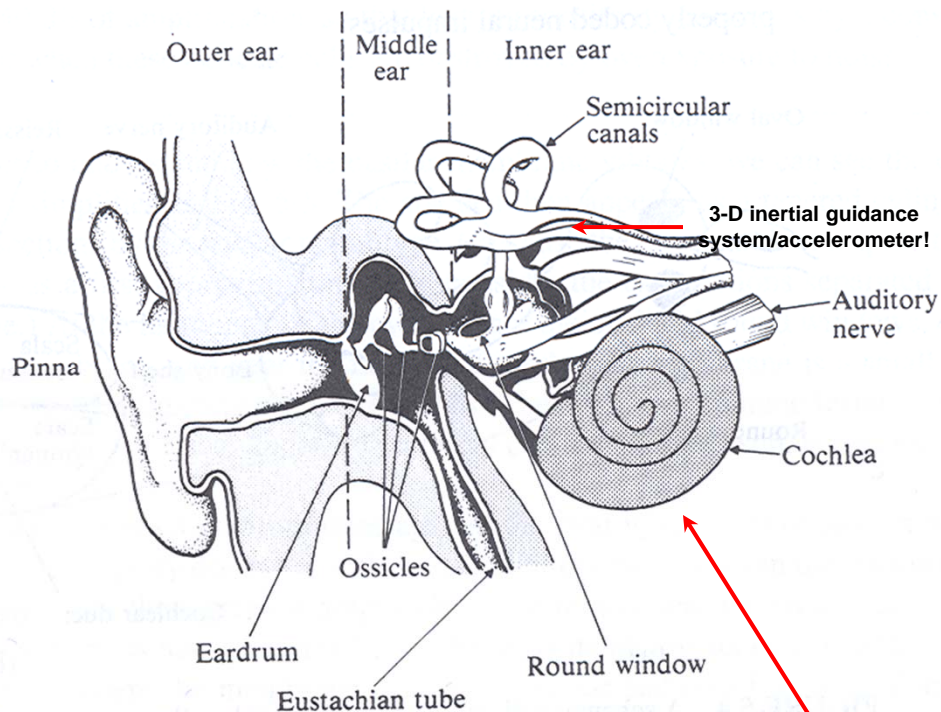
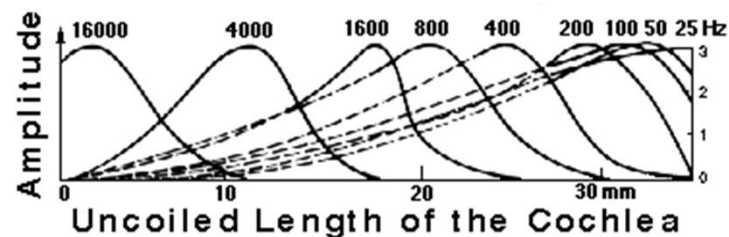

FIG. 1. Schematic diagram of the human ear, with the cochlea uncoiled.



Pinna acts as ~ parabolic collector of sound

Mechanical amplification factor of ear drum \Rightarrow ossicles (~ 1.3) \Rightarrow oval window $\sim 13\times$

$$(A_{\text{ear drum}}/A_{\text{oval window}} \sim 10)$$

Resonances in the auditory canal (~ 2 cm long \sim open-closed organ pipe) boost ear's sensitivity in the $\sim 2 - 5$ KHz range

n.b. also explains e.g. midrange hearing loss due to excessively loud rock music...

Nonlinear relationship between max $A(f)$ vs. location along cochlea.

n.b. Spiral shape of cochlea boosts sensitivity to low frequencies by ~ 20 dB! D. Manoussaki, et al., Phys. Rev. Lett. 96, 088701 (2006)

The Organ of Corti & Inner/Outer Hair Cells, Stereocilia:

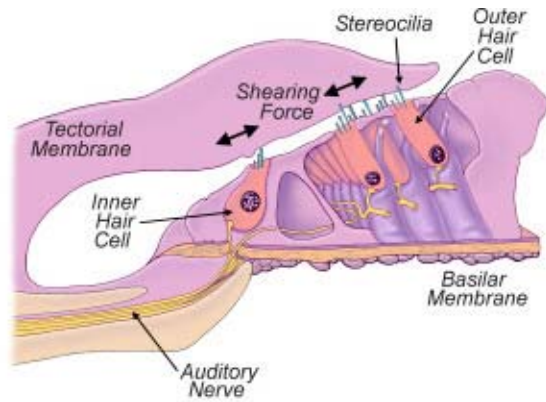

The Organ of Corti

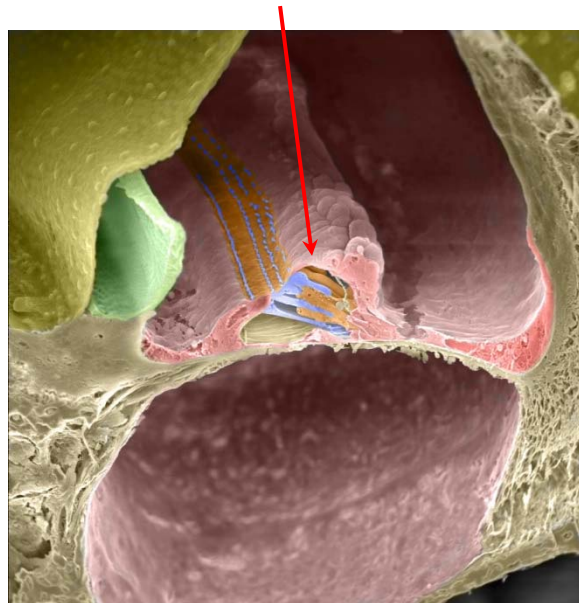

A triple-row of ~ 12,000 chevron-shaped *outer* hair cells – via their stereocilia act as **biological amplifiers**, boosting the sensitivity level of human hearing by ~ 40 dB!

~ 4000 *inner* hair cells – via their stereocilia generate the primary auditory signals sent along the auditory nerve to the brain

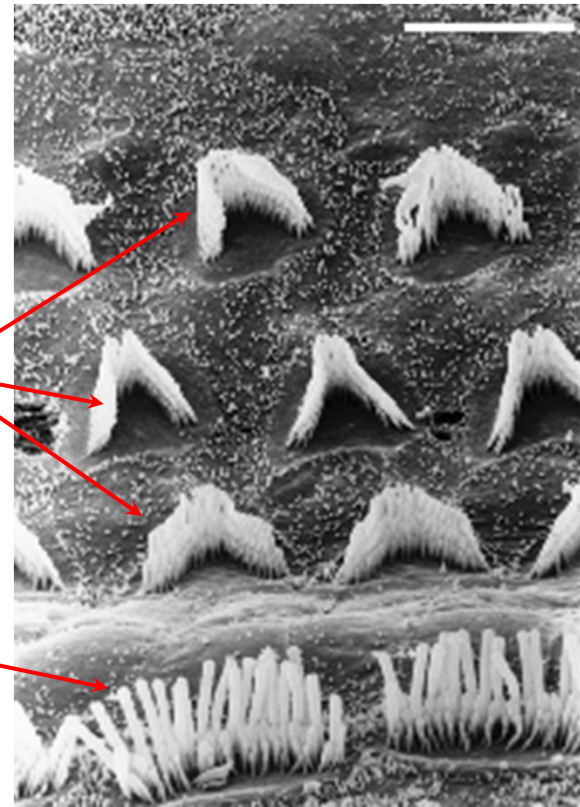
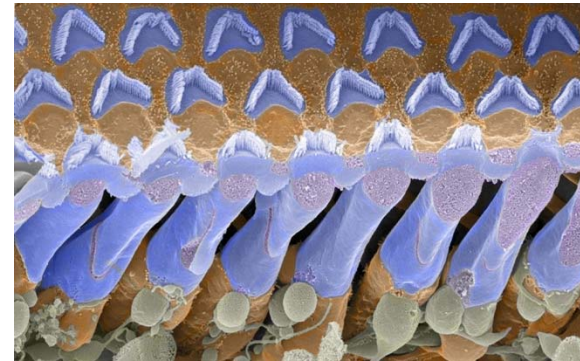

Action of Hair Cells, Auditory Nerve & Auditory Pathway to Brain:

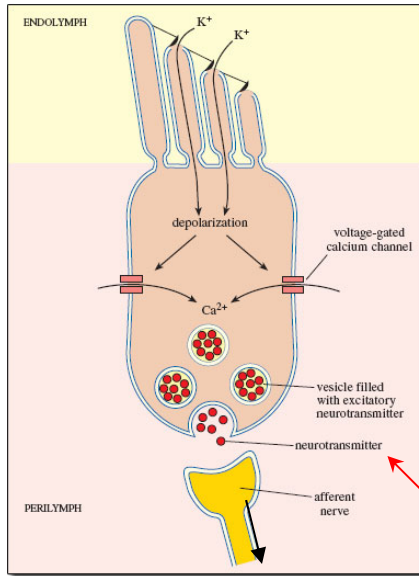

~ 95% of auditory nerve fibers (type I) are connected to ~ 4000 *inner* hair cells, each of which directs its output to up to ~ 10 type I auditory nerve fibers.

Type I auditory nerve fibers are *bipolar* and are myelinated (i.e. have nerve sheath) – boosts transmission speed of action potentials along nerve fiber by factor of up to ~ 300x over non-myelinated nerve fibers – evolutionarily very important – for our auditory startle reflex!

TRPA1 protein

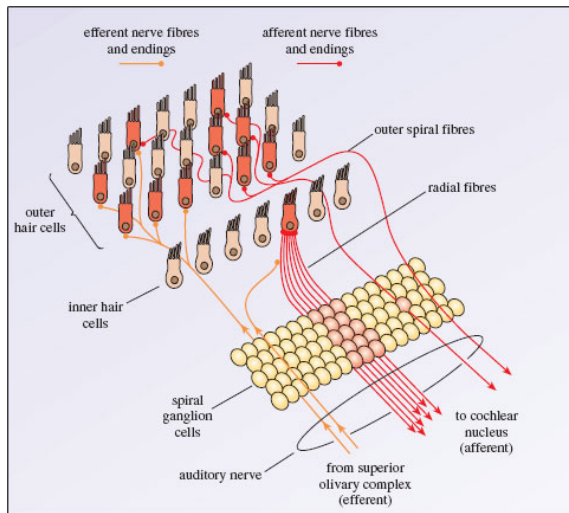

~ 5% of auditory nerve fibers (type II) are connected to ~ 12,000 *outer* hair cells, are *monopolar* and are *not* myelinated (i.e. slow..)

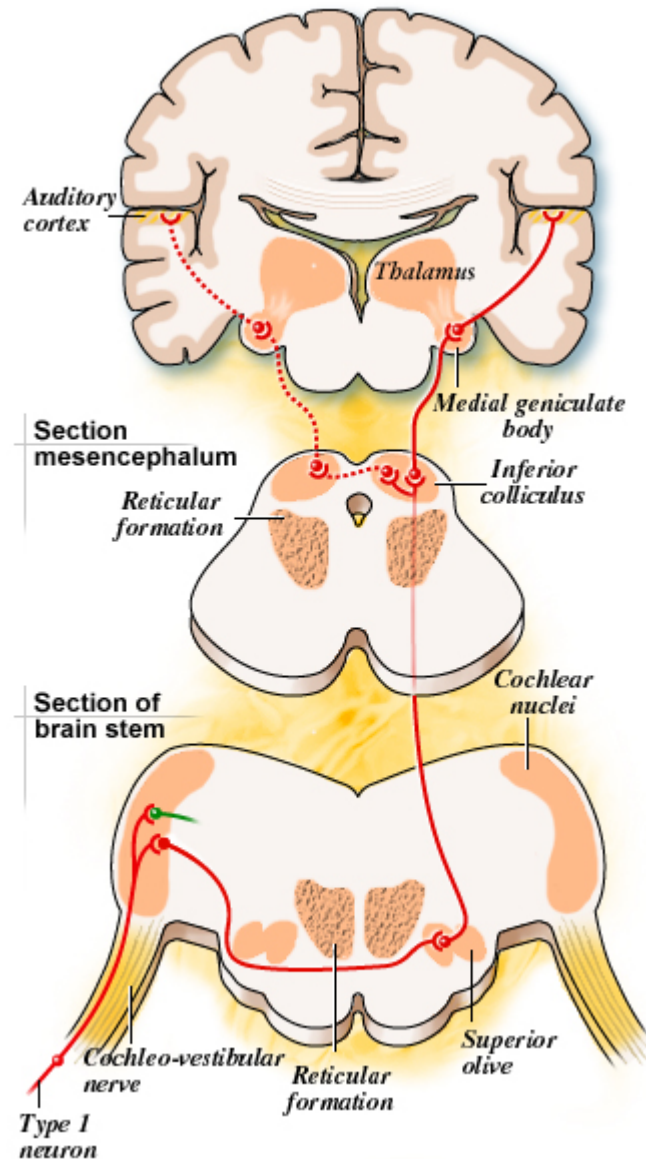

Monaural Auditory Response to Two Pure Tones, Critical Band:

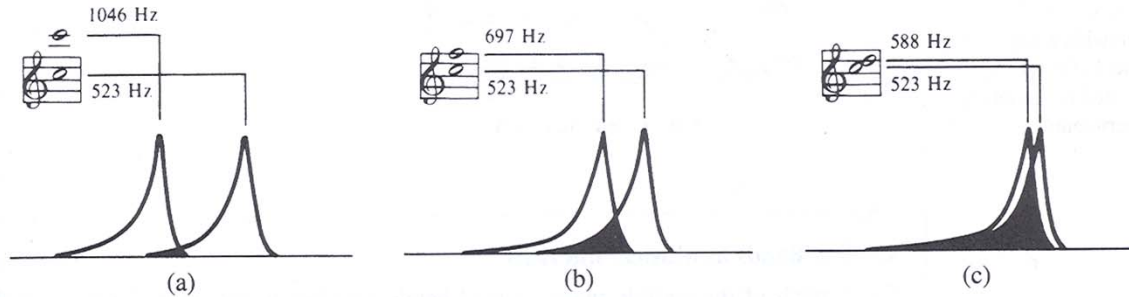
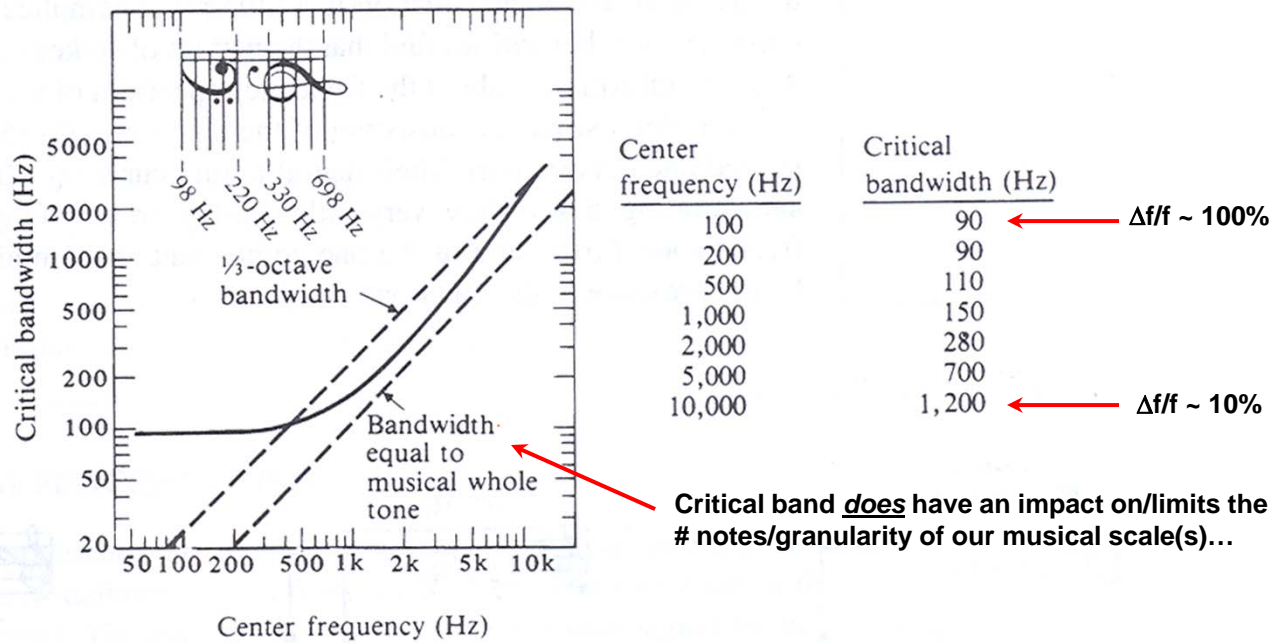
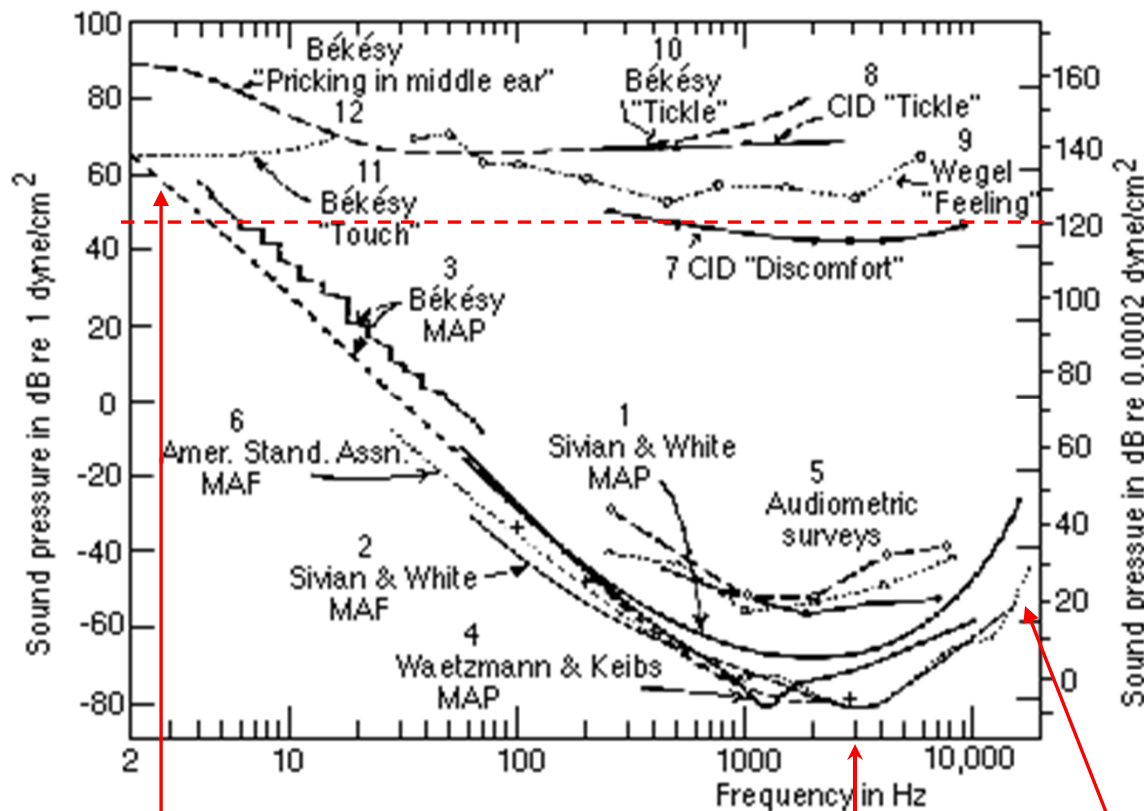

FIGURE 5.9 Frequency response curves for pairs of pure tones. As the interval between them decreases, their response curves show increasing overlap.



Sensitivity of Human Hearing vs. Frequency:



The human ear responds ~ logarithmically to pressure. The minimum audible RMS over-pressure (MAP) amplitude defined at $f = 1 \text{ KHz}$:

$$p_o(f = 1 \text{ KHz}) = 2 \times 10^{-5} \text{ RMS Pascals}$$

Since $p_{atm} = 10^5 \text{ Pascals}$, humans can detect pressure variations of order ~ 1 part in 10^{10} of atmospheric pressure (n.b. dogs ~ 100× better!)

Corresponding minimum audible longitudinal particle velocity, longitudinal particle displacement and sound intensity at $f = 1 \text{ KHz}$ are:

$$u_o(f = 1 \text{ KHz}) = 4.8 \times 10^{-8} \text{ RMS m/s}$$

$$\xi_o(f = 1 \text{ KHz}) = 7.7 \times 10^{-12} \text{ RMS m}$$

$$I_o(f = 1 \text{ KHz}) = 10^{-12} \text{ RMS Watts/m}^2$$

n.b. typical size of an atom ~ few Angstroms (i.e. ~ $\text{few} \times 10^{-10} \text{ m}$)

{Bohr radius of Hydrogen atom ~ $\frac{1}{2}$ Angstrom}

Sensitivity at high frequencies needed for transients – e.g. intelligibility of consonants

n.b. Low-frequency roll-off totally desensitizes us e.g. to ambient ~ $1/f$ noise, and also e.g. draft noise around ears while walking...

Frequency range of low-order harmonics of typical human voice

Max sensitivity here due to resonance in ear canal (open-closed organ pipe)

Our Perception of Frequency – Pitch – is {also} Non-Linear:

Only 3 decades of dynamic range in frequency: $20 \text{ Hz} < f < 20 \text{ KHz}$

Define “units” associated with
subjective pitch = **mels**
 \Leftrightarrow analogous to **Hz**.

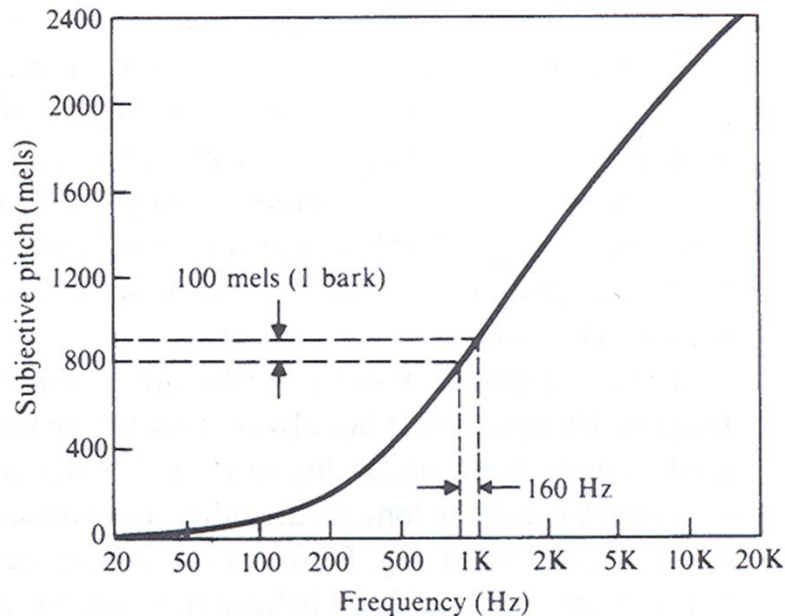

We also require a minimum time duration (min # cycles) in order to perceive a definite pitch:

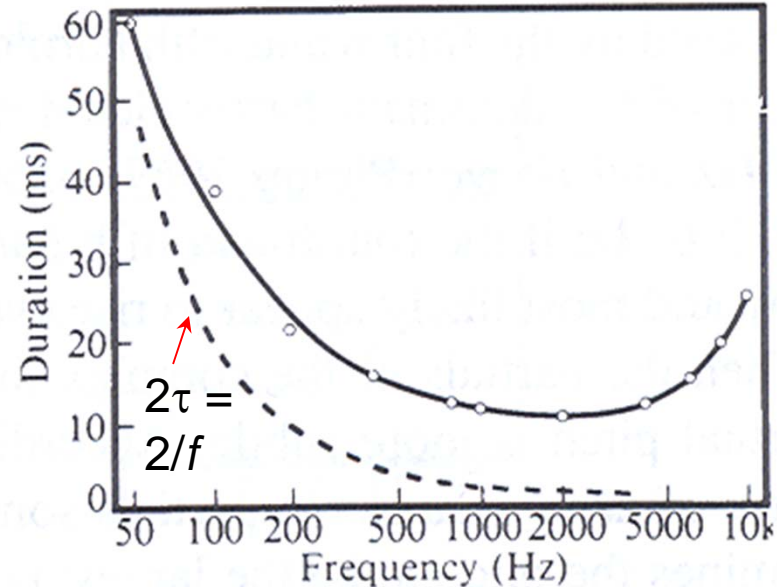

Binaural Hearing and Sound Localization:

For frequencies between $\sim 100 \text{ Hz} < f < \sim 1.5 \text{ KHz}$, we use inter-aural arrival time difference information Δt (for impulse-type sounds) or equivalently, phase difference information $\Delta\phi = \Delta t/\tau$ (for periodic sounds) for localizing source(s) of sounds:

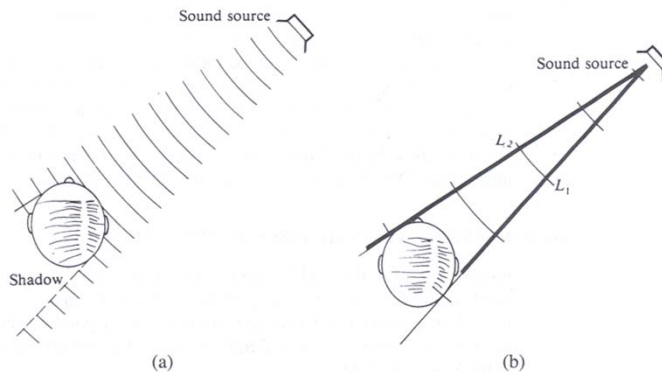

For frequencies above $\sim 4 \text{ KHz}$, sound localization increasingly relies on sound intensity difference information (JND $\sim 1 \text{ dB}$) – Our head casts a shadow on the “away” side.

At $f \sim 1 \text{ KHz}$, $\Delta\text{SPL} \sim 8 \text{ dB}$; at $f \sim 10 \text{ KHz}$, $\Delta\text{SPL} \sim 30 \text{ dB}$ or more. This spatial localization “algorithm” fails at low frequencies due to sound diffraction...

The “algorithm” also fails at certain angles due to the acoustic analog of the Fresnel / Arago / Poisson bright spot!

Typical {adult} ear-ear separation distance is $d_{\text{ears}} \sim 15 \text{ cm}$. Corresponding *maximum* arrival time *difference* in air (@ NTP) is $\Delta t \sim d_{\text{ears}}/v \sim 0.44 \text{ msec}$. Can easily localize sounds to within $\sim 5^\circ$ in horizontal plane in front of us $\Rightarrow \Delta t_{\text{min}} \sim 10 \mu\text{sec!}$



n.b. Human's have extremely difficult time localizing sounds in water $v_{\text{H}_2\text{O}} \sim 4.4x v_{\text{air}}$, whereas e.g. dolphins, etc. have no such problems!

\Rightarrow Their hearing optimized for sound propagation in water, whereas our hearing is optimized for sound propagation in air!

\Rightarrow Alien life forms: their hearing optimized for specifics of their environment!

Forward orientation of our pinnae aids us {optimally} in localizing sounds in \sim horizontal plane in front of us (vertical & rearward sound localization degraded as a consequence).

Folds in the pinnae (unique to each human!) enhance our ability to localize sounds in the higher frequency region.

n.b. Long ago, we used to have movable ears (like donkeys)...

Localization of Sounds Using Phase/Inter-aural Time-Difference Information:

One ear – not sensitive to absolute phase.

Two ears – sensitive to phase (= time) differences over frequency range of $\sim 100 \text{ Hz} < f < 1500 \text{ Hz}$.

We humans can easily localize e.g. pure-tone/single frequency sounds {in this frequency range} with angular resolution of $\delta\theta \sim 5^\circ$, which corresponds to a time diff resolution of $\delta t \sim 40 \mu\text{s}$ {also relevant for impulsive/transient sounds/sound pulses (consisting of a spectral continuum of frequencies)}

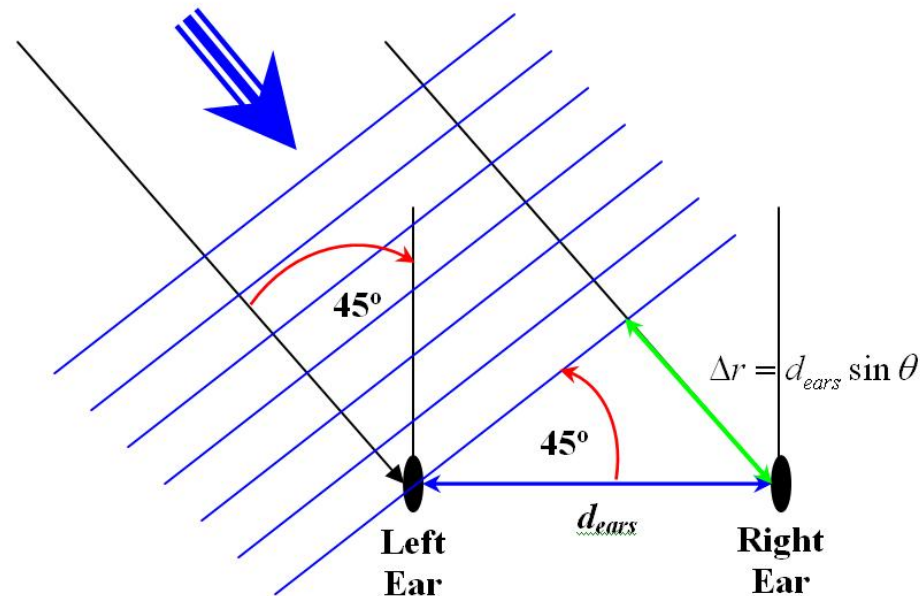

Acoustic Analog of the Fresnel/Arago/Poisson Bright Spot:

Circular obstacle, $d = 1$ mm

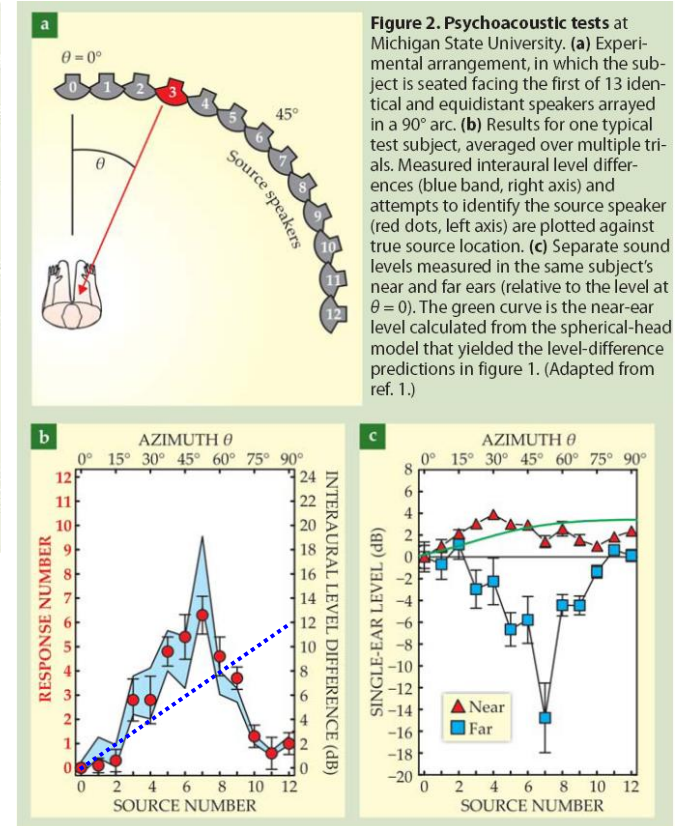
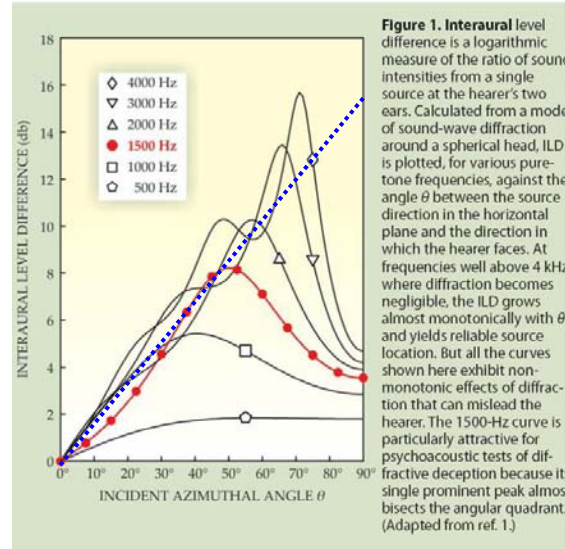
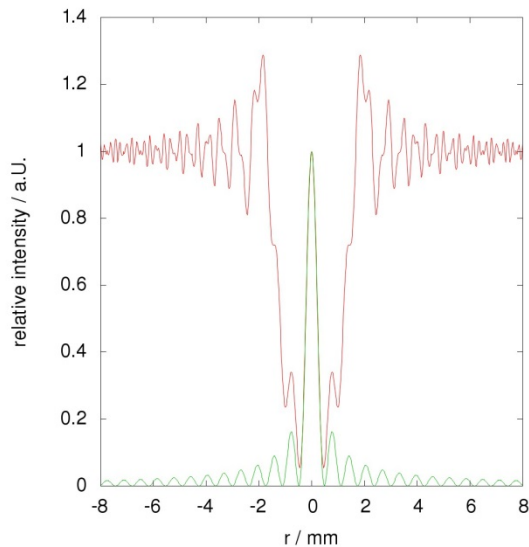
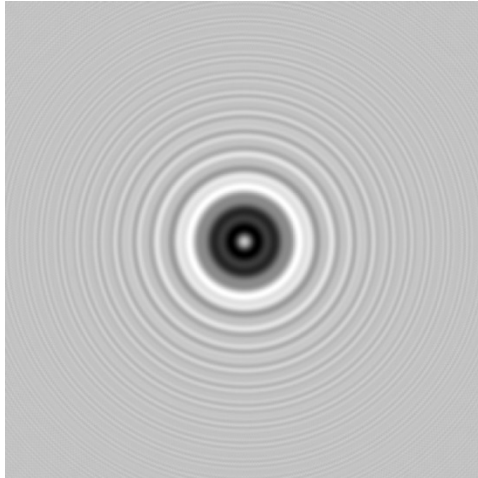

E. Macaulay, *et al.*, (EM's MSU PhD Thesis; former 2003 POM UIUC NSF REU student!) "The Acoustical Bright Spot and Mislocalization of Tones By Human Listeners", *J. Acoust. Soc. Am.* 127, 1440-1449 (2010)

Harmonic Content of the Human Voice – First Human Musical Instrument: Comparison of 3 UIUC Physics 193POM/UIUC Women’s Choir students singing D4 “Ooooh” (293.66 Hz):

Abby

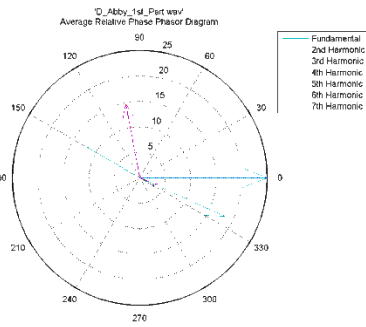
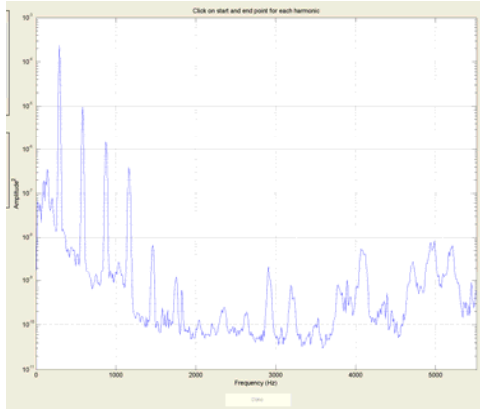

R = Mean Normalized Amplitude (dB) (Fundamental = 25 dB)
Theta = Relative Phase (degrees)

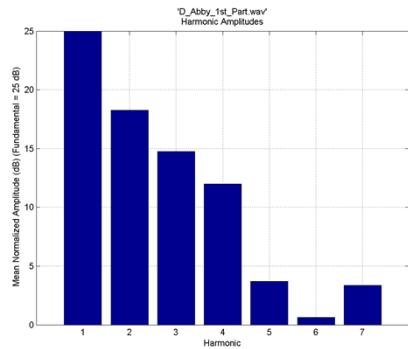

Molly

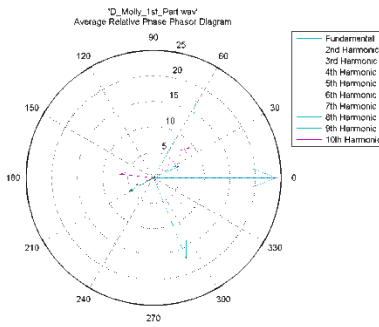
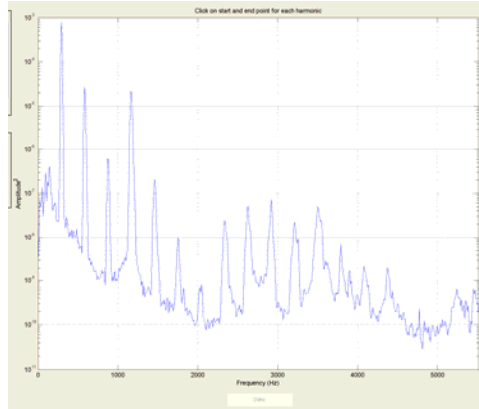

R = Mean Normalized Amplitude (dB) (Fundamental = 24 dB)
Theta = Relative Phase (degrees)

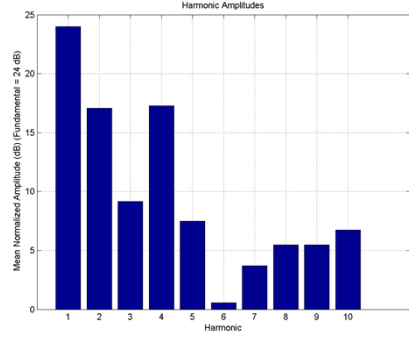

Cheryl

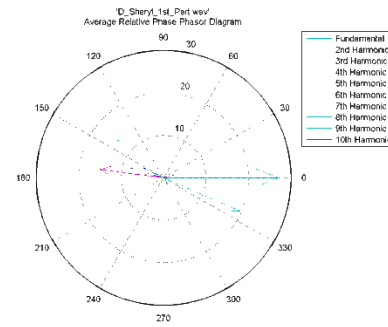
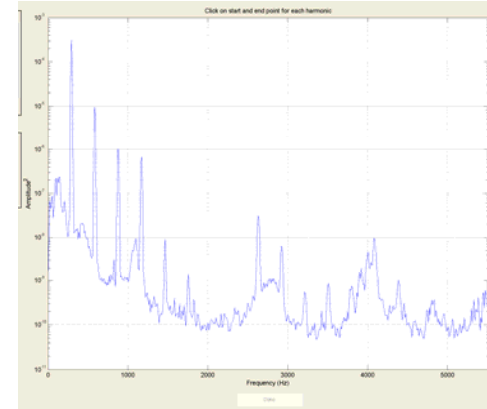

R = Mean Normalized Amplitude (dB) (Fundamental = 27 dB)
Theta = Relative Phase (degrees)

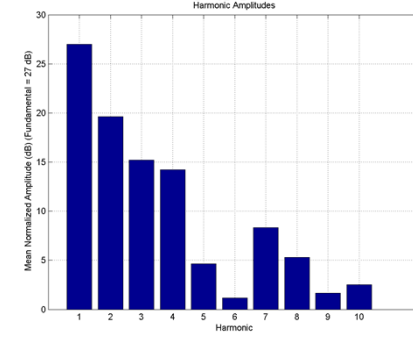

Harmonic Content of Vowels: John Nichols, P498POM Spring, 2010

High "Aaaaay"

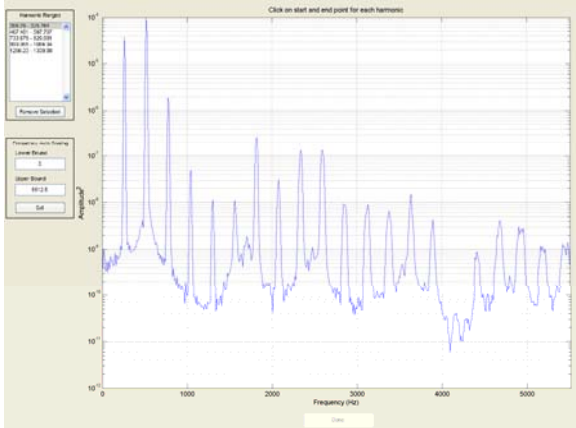

High "Eeeey"

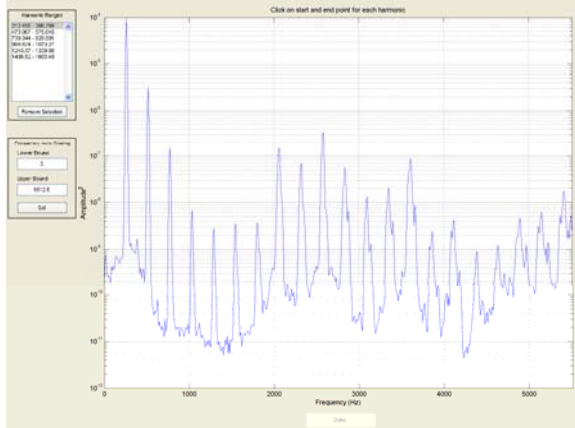

High "Oooooh"

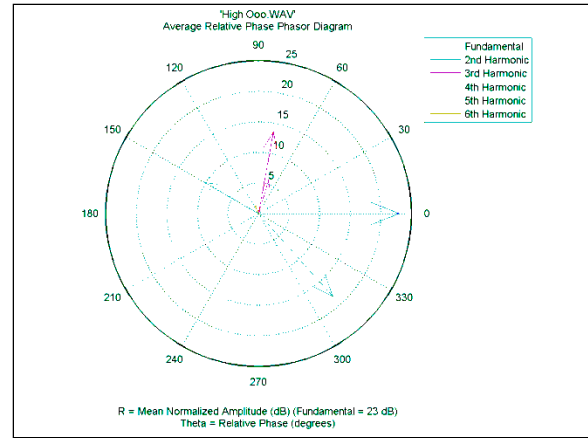
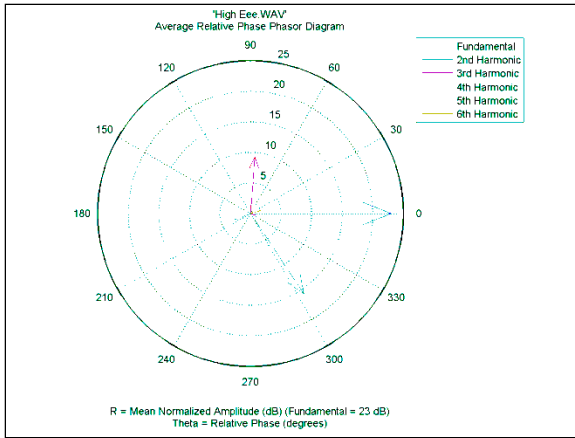
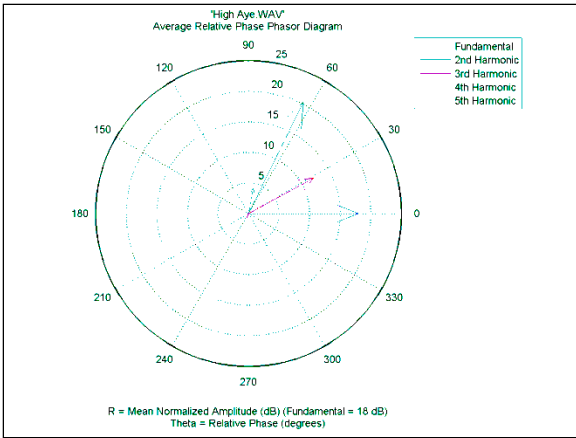
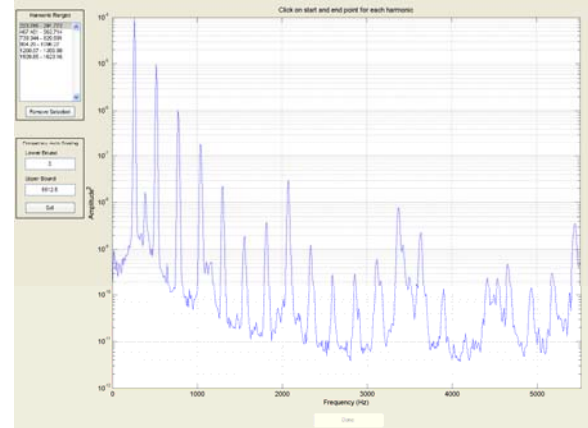

The Phenomenon of Consonance & Dissonance – Pleasing & Displeasing Sounds – Why So???

Studied by Greek Philosopher Pythagoras (~ 500 BCE) – e.g. using the monochord:

Two frequencies (fundamentals) associated with the vibrating string segments (with common string tension T:

$$f_x = v/2x \quad f_{L-x} = v/2(L-x)$$

Consonance occurs when frequency ratios = ratio of two low-order integers $m:n$
 \Rightarrow phase stable waveforms, e.g:

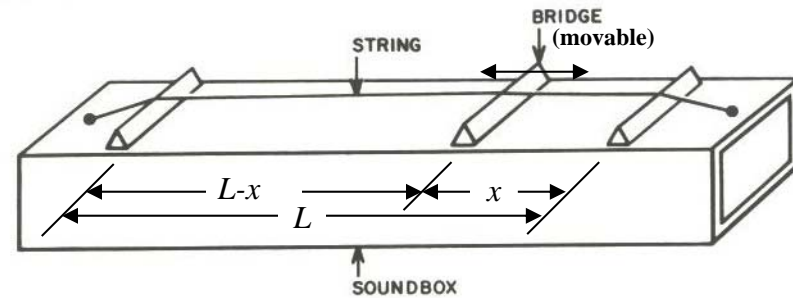

FIG. 1. The monochord.

Unison {1:1}

In-Phase:

Quadrature:

Major Fifth {3:2}

In-Phase:

Quadrature:

Octave {2:1}

In-Phase:

Quadrature:

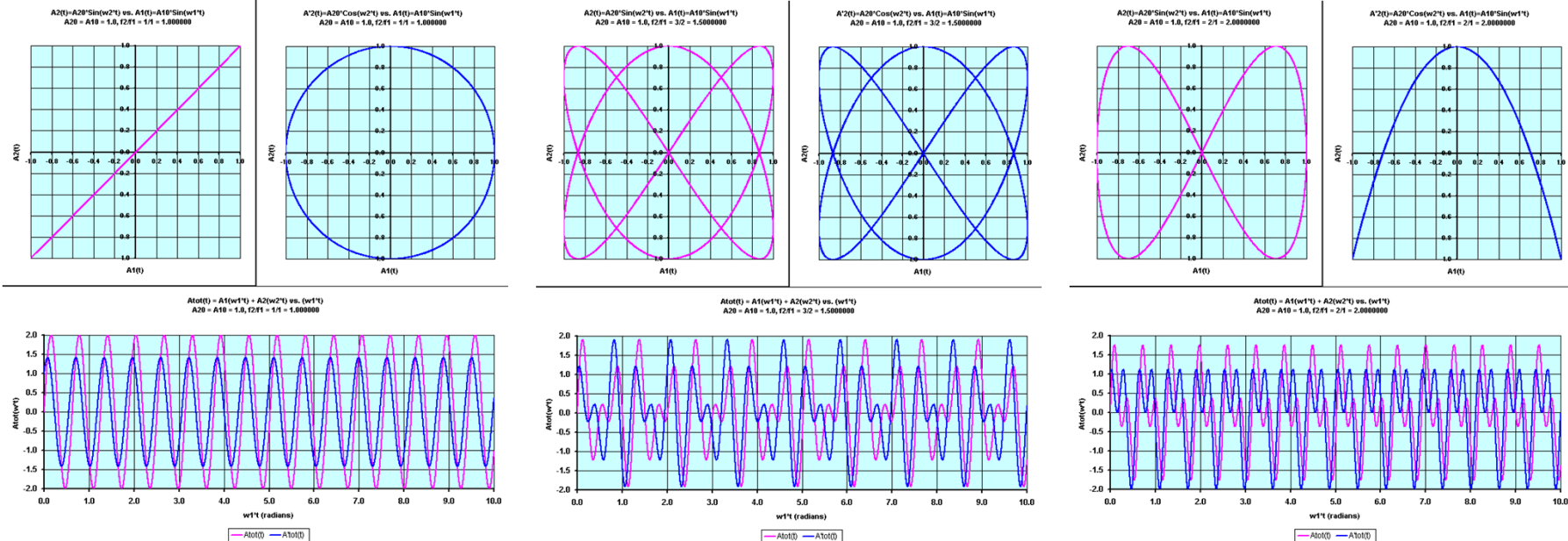

Consonance/Dissonance Demo: hear/see/touch/feel...

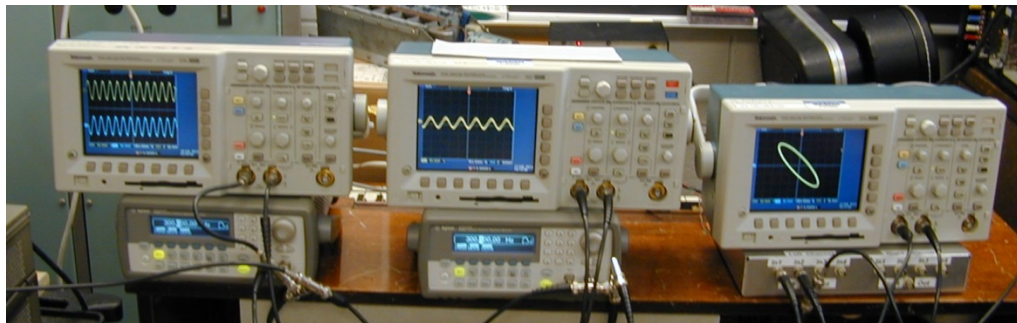
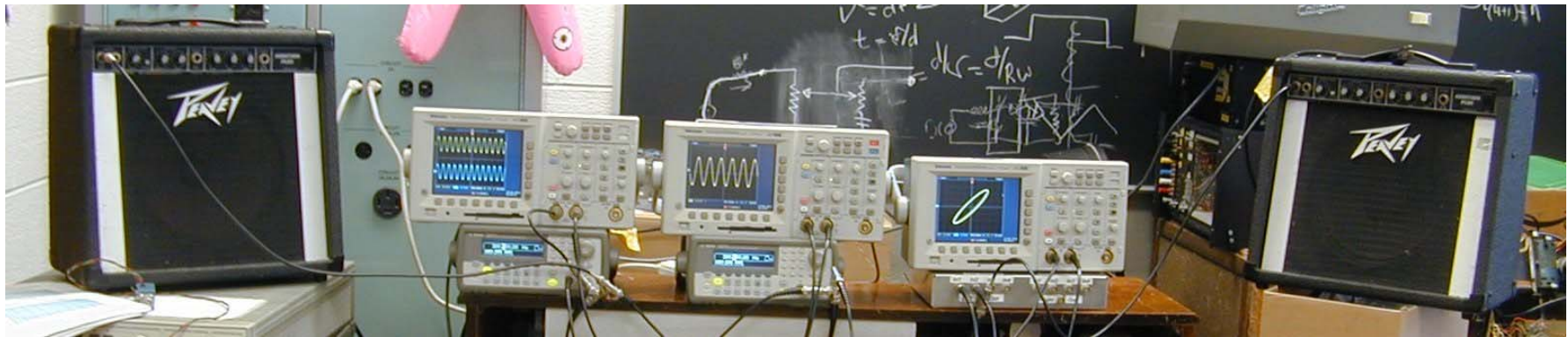

Consonant frequency intervals have phase-stable waveforms – with short repeat times
 – very easy for human ear to analyze:

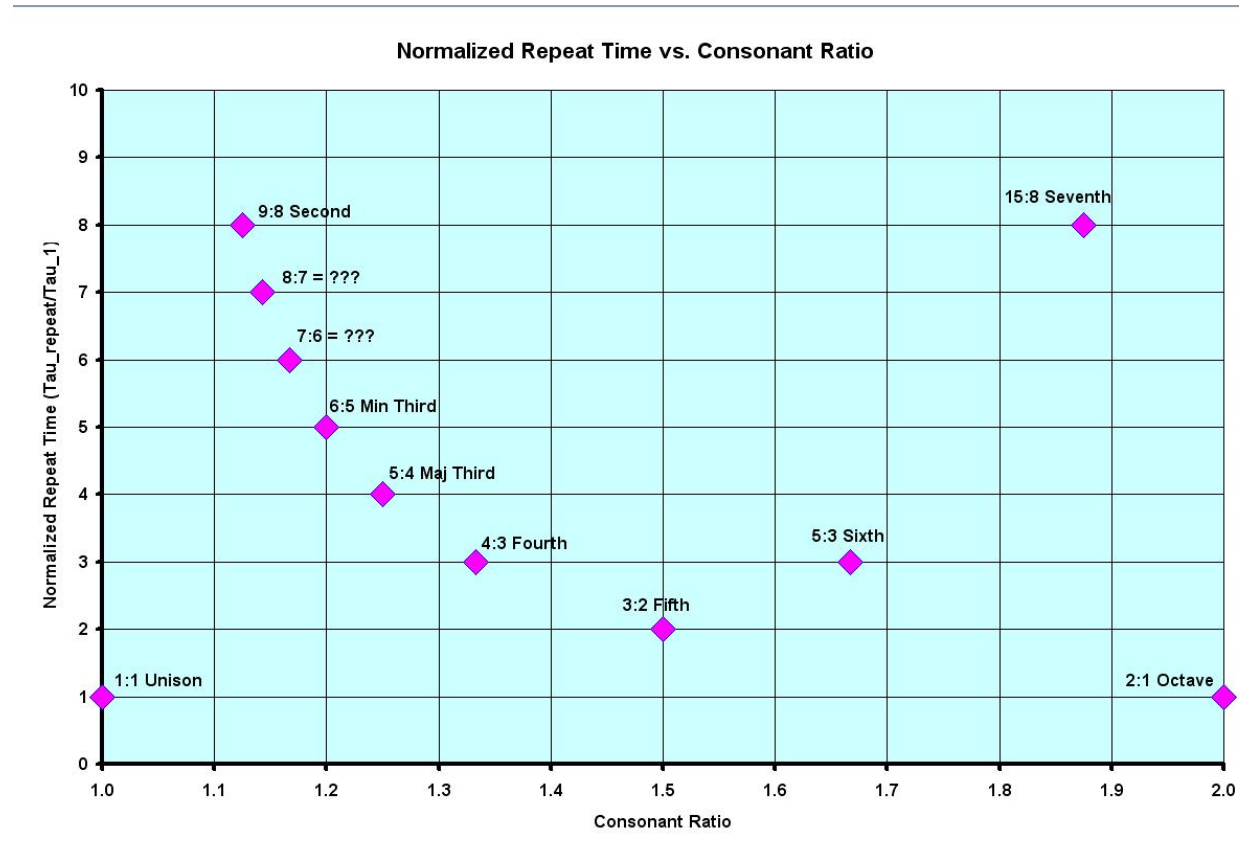

The lower frequency determines the repeat time

No phase stability for dissonant/non-consonant/non-integer frequency ratios – repeat times can be infinitely long... requires more mental effort to analyze...

Our human brains have separate neural circuits for analyzing sounds to determine whether sounds are consonant {human voice-like sound – i.e. integer-related harmonics} vs. dissonant {not-human voice-like sound...} – the outputs of which are also wired into different emotional centers!

“Natural” notion of musical scale{s} (& e.g. circle of fifths) intimately connected to consonant intervals:

Note:	C	D	F	G	A	C
Frequency:	f	$\frac{9}{8}f$	$\frac{4}{3}f$	$\frac{3}{2}f$	$\frac{27}{16}f$	$2f$

FIG. 3. A pentatonic scale.

Musical scale is fundamentally imperfect (consonance perspective):

	D \flat	E \flat		G \flat	A \flat	B \flat							
	C \sharp	D \sharp		F \sharp	G \sharp	A \sharp							
	C	D	E	F	G	A	B	C					
$a \equiv 2^{1/12}$	a	a^3		a^6	a^8	a^{10}							
	1	a^2	a^4	a^5	a^7	a^9	a^{11}	a^{12}					
	1.000	1.059	1.122	1.189	1.260	1.335	1.414	1.498	1.587	1.682	1.782	1.888	2.000

FIG. 10. The tempered scale.

The tempered scale enables one to play songs in any key – The song will then sound the same {equally musically “bad”} in each key!

Note:	C	D	E	F	G	A	B	C
Frequency:	1	$\frac{9}{8}$	$\frac{81}{64}$	$\frac{4}{3}$	$\frac{3}{2}$	$\frac{27}{16}$	$\frac{243}{128}$	2
Interval:		$\frac{9}{8}$	$\frac{9}{8}$	$\frac{256}{243}$	$\frac{9}{8}$	$\frac{9}{8}$	$\frac{9}{8}$	$\frac{256}{243}$

FIG. 4. The Pythagorean scale.

Note:	C	D	E	F	G	A	B	C
Frequency:	1	$\frac{9}{8}$	$\frac{5}{4}$	$\frac{4}{3}$	$\frac{3}{2}$	$\frac{5}{3}$	$\frac{15}{8}$	2
Interval:		$\frac{9}{8}$	$\frac{10}{9}$	$\frac{16}{15}$	$\frac{9}{8}$	$\frac{10}{9}$	$\frac{9}{8}$	$\frac{16}{15}$

FIG. 8. The just diatonic scale.

n.b. For musical instruments, if transpose songs in these scales to another key, won’t sound the same because the *intervals* between the notes are not the same in all keys....

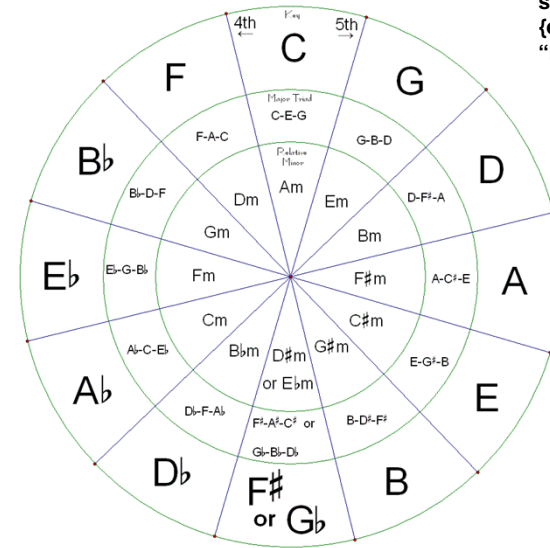

The Circle of Fifths

Consonance & Dissonance of Complex Tones – Just Diatonic Scale

Consonance of Harmonics – Just Diatonic Scale

Explanation: If two complex tones – e.g. two square or triangle waves and/or two musical tones with integer-related harmonics are superposed/added together – e.g. as unison, 2nd, minor 3rd, major 3rd, 4th, 5th, ... octave in the just diatonic scale, the colored boxes in the tables below indicate the overlap of harmonics from the two sounds that will be consonant with each other. Thus, e.g. two complex tones in unison, a fifth apart or an octave apart are quite consonant with each other, whereas two complex tones that are e.g. a 2nd or a 7th apart are quite dissonant-sounding.

Fundamental Frequency, $f_0 = 100$ Hz

Harmonic #	Unison C-C 1:1	Second D-C 9:8	??? ???-C 8:7	??? ???-C 7:6	Minor 3rd E _b -C 6:5	Major 3rd E-C 5:4	Fourth F-C 4:3	Fifth G-C 3:2	Sixth A-C 5:3	Seventh B-C 15:8	Octave C-C 2:1
1	100.0	112.5	114.3	116.7	120.0	125.0	133.3	150.0	166.7	187.5	200.0
2	200.0	225.0	228.6	233.3	240.0	250.0	266.7	300.0	333.3	375.0	400.0
3	300.0	337.5	342.9	350.0	360.0	375.0	400.0	450.0	500.0	562.5	600.0
4	400.0	450.0	457.1	466.7	480.0	500.0	533.3	600.0	666.7	750.0	800.0
5	500.0	562.5	571.4	583.3	600.0	625.0	666.7	750.0	833.3	937.5	1000.0
6	600.0	675.0	685.7	700.0	720.0	750.0	800.0	900.0	1000.0	1125.0	1200.0
7	700.0	787.5	800.0	816.7	840.0	875.0	933.3	1050.0	1166.7	1312.5	1400.0
8	800.0	900.0	914.3	933.3	960.0	1000.0	1066.7	1200.0	1333.3	1500.0	1600.0
9	900.0	1012.5	1028.6	1050.0	1080.0	1125.0	1200.0	1350.0	1500.0	1687.5	1800.0
10	1000.0	1125.0	1142.9	1166.7	1200.0	1250.0	1333.3	1500.0	1666.7	1875.0	2000.0
11	1100.0	1237.5	1257.1	1283.3	1320.0	1375.0	1466.7	1650.0	1833.3	2062.5	2200.0
12	1200.0	1350.0	1371.4	1400.0	1440.0	1500.0	1600.0	1800.0	2000.0	2250.0	2400.0
13	1300.0	1462.5	1485.7	1516.7	1560.0	1625.0	1733.3	1950.0	2166.7	2437.5	2600.0
14	1400.0	1575.0	1600.0	1633.3	1680.0	1750.0	1866.7	2100.0	2333.3	2625.0	2800.0
15	1500.0	1687.5	1714.3	1750.0	1800.0	1875.0	2000.0	2250.0	2500.0	2812.5	3000.0
16	1600.0	1800.0	1828.6	1866.7	1920.0	2000.0	2133.3	2400.0	2666.7	3000.0	3200.0
17	1700.0	1912.5	1942.9	1983.3	2040.0	2125.0	2266.7	2550.0	2833.3	3187.5	3400.0
18	1800.0	2025.0	2057.1	2100.0	2160.0	2250.0	2400.0	2700.0	3000.0	3375.0	3600.0
19	1900.0	2137.5	2171.4	2216.7	2280.0	2375.0	2533.3	2850.0	3166.7	3562.5	3800.0
20	2000.0	2250.0	2285.7	2333.3	2400.0	2500.0	2666.7	3000.0	3333.3	3750.0	4000.0
21	2100.0	2362.5	2400.0	2450.0	2520.0	2625.0	2800.0	3150.0	3500.0	3937.5	4200.0
22	2200.0	2475.0	2514.3	2566.7	2640.0	2750.0	2933.3	3300.0	3666.7	4125.0	4400.0
23	2300.0	2587.5	2628.6	2683.3	2760.0	2875.0	3066.7	3450.0	3833.3	4312.5	4600.0
24	2400.0	2700.0	2742.9	2800.0	2880.0	3000.0	3200.0	3600.0	4000.0	4500.0	4800.0
25	2500.0	2812.5	2857.1	2916.7	3000.0	3125.0	3333.3	3750.0	4166.7	4687.5	5000.0
26	2600.0	2925.0	2971.4	3033.3	3120.0	3250.0	3466.7	3900.0	4333.3	4875.0	5200.0
27	2700.0	3037.5	3085.7	3150.0	3240.0	3375.0	3600.0	4050.0	4500.0	5062.5	5400.0
28	2800.0	3150.0	3200.0	3266.7	3360.0	3500.0	3733.3	4200.0	4666.7	5250.0	5600.0
29	2900.0	3262.5	3314.3	3383.3	3480.0	3625.0	3866.7	4350.0	4833.3	5437.5	5800.0
30	3000.0	3375.0	3428.6	3500.0	3600.0	3750.0	4000.0	4500.0	5000.0	5625.0	6000.0
31	3100.0	3487.5	3542.9	3616.7	3720.0	3875.0	4133.3	4650.0	5166.7	5812.5	6200.0
32	3200.0	3600.0	3657.1	3733.3	3840.0	4000.0	4266.7	4800.0	5333.3	6000.0	6400.0

Dissonance of Harmonics – Just Diatonic Scale

Explanation: If two complex tones – e.g. two square or triangle waves and/or two musical tones with integer-related harmonics are superposed/added together – e.g. as unison, 2nd, minor 3rd, major 3rd, 4th, 5th, ... octave in the just diatonic scale, the colored boxes in the tables below indicate the overlap of harmonics from the two sounds are within the critical band of the human ear and hence will be dissonant with each other. Thus, e.g. two complex tones in unison, a fifth apart or an octave apart are quite consonant with each other, whereas two complex tones that are e.g. a 2nd or a 7th apart are quite dissonant-sounding.

Fundamental Frequency, $f_0 = 100$ Hz

Harmonic #	Unison C-C 1:1	Second D-C 9:8	??? ???-C 8:7	??? ???-C 7:6	Minor 3rd E _b -C 6:5	Major 3rd E-C 5:4	Fourth F-C 4:3	Fifth G-C 3:2	Sixth A-C 5:3	Seventh B-C 15:8	Octave C-C 2:1
1	100.0	112.5	114.3	116.7	120.0	125.0	133.3	150.0	166.7	187.5	200.0
2	200.0	225.0	228.6	233.3	240.0	250.0	266.7	300.0	333.3	375.0	400.0
3	300.0	337.5	342.9	350.0	360.0	375.0	400.0	450.0	500.0	562.5	600.0
4	400.0	450.0	457.1	466.7	480.0	500.0	533.3	600.0	666.7	750.0	800.0
5	500.0	562.5	571.4	583.3	600.0	625.0	666.7	750.0	833.3	937.5	1000.0
6	600.0	675.0	685.7	700.0	720.0	750.0	800.0	900.0	1000.0	1125.0	1200.0
7	700.0	787.5	800.0	816.7	840.0	875.0	933.3	1050.0	1166.7	1312.5	1400.0
8	800.0	900.0	914.3	933.3	960.0	1000.0	1066.7	1200.0	1333.3	1500.0	1600.0
9	900.0	1012.5	1028.6	1050.0	1080.0	1125.0	1200.0	1350.0	1500.0	1687.5	1800.0
10	1000.0	1125.0	1142.9	1166.7	1200.0	1250.0	1333.3	1500.0	1666.7	1875.0	2000.0
11	1100.0	1237.5	1257.1	1283.3	1320.0	1375.0	1466.7	1650.0	1833.3	2062.5	2200.0
12	1200.0	1350.0	1371.4	1400.0	1440.0	1500.0	1600.0	1800.0	2000.0	2250.0	2400.0
13	1300.0	1462.5	1485.7	1516.7	1560.0	1625.0	1733.3	1950.0	2166.7	2437.5	2600.0
14	1400.0	1575.0	1600.0	1633.3	1680.0	1750.0	1866.7	2100.0	2333.3	2625.0	2800.0
15	1500.0	1687.5	1714.3	1750.0	1800.0	1875.0	2000.0	2250.0	2500.0	2812.5	3000.0
16	1600.0	1800.0	1828.6	1866.7	1920.0	2000.0	2133.3	2400.0	2666.7	3000.0	3200.0
17	1700.0	1912.5	1942.9	1983.3	2040.0	2125.0	2266.7	2550.0	2833.3	3187.5	3400.0
18	1800.0	2025.0	2057.1	2100.0	2160.0	2250.0	2400.0	2700.0	3000.0	3375.0	3600.0
19	1900.0	2137.5	2171.4	2216.7	2280.0	2375.0	2533.3	2850.0	3166.7	3562.5	3800.0
20	2000.0	2250.0	2285.7	2333.3	2400.0	2500.0	2666.7	3000.0	3333.3	3750.0	4000.0
21	2100.0	2362.5	2400.0	2450.0	2520.0	2625.0	2800.0	3150.0	3500.0	3937.5	4200.0
22	2200.0	2475.0	2514.3	2566.7	2640.0	2750.0	2933.3	3300.0	3666.7	4125.0	4400.0
23	2300.0	2587.5	2628.6	2683.3	2760.0	2875.0	3066.7	3450.0	3833.3	4312.5	4600.0
24	2400.0	2700.0	2742.9	2800.0	2880.0	3000.0	3200.0	3600.0	4000.0	4500.0	4800.0
25	2500.0	2812.5	2857.1	2916.7	3000.0	3125.0	3333.3	3750.0	4166.7	4687.5	5000.0
26	2600.0	2925.0	2971.4	3033.3	3120.0	3250.0	3466.7	3900.0	4333.3	4875.0	5200.0
27	2700.0	3037.5	3085.7	3150.0	3240.0	3375.0	3600.0	4050.0	4500.0	5062.5	5400.0
28	2800.0	3150.0	3200.0	3266.7	3360.0	3500.0	3733.3	4200.0	4666.7	5250.0	5600.0
29	2900.0	3262.5	3314.3	3383.3	3480.0	3625.0	3866.7	4350.0	4833.3	5437.5	5800.0
30	3000.0	3375.0	3428.6	3500.0	3600.0	3750.0	4000.0	4500.0	5000.0	5625.0	6000.0
31	3100.0	3487.5	3542.9	3616.7	3720.0	3875.0	4133.3	4650.0	5166.7	5812.5	6200.0
32	3200.0	3600.0	3657.1	3733.3	3840.0	4000.0	4266.7	4800.0	5333.3	6000.0	6400.0

Universal $1/f^\beta$ “Noise” in Natural (and Man-Made) Systems:

There exists an ever-growing, long list of natural & man-made processes exhibiting “universal” $1/f^\beta$ fluctuations (aka “noise”) where the exponent $0 < \beta < 2$:

⇒ Intimately connected to fractals
(B. Mandelbrot, 1977)

Examples:

- Carbon-composition resistors, vacuum tubes, semiconducting devices
- Weather patterns (e.g. rainfall, annual flooding of Nile River...)
- Radioactive decay(s)
- Traffic Flow, Financial Transactions, ...
- Signals in {mylenated} nerves ← important ramifications for human music!
-
-

For a more comprehensive list of such processes, see e.g.

<http://www.nslj-genetics.org/wli/1fnoise/index-by-category.html>

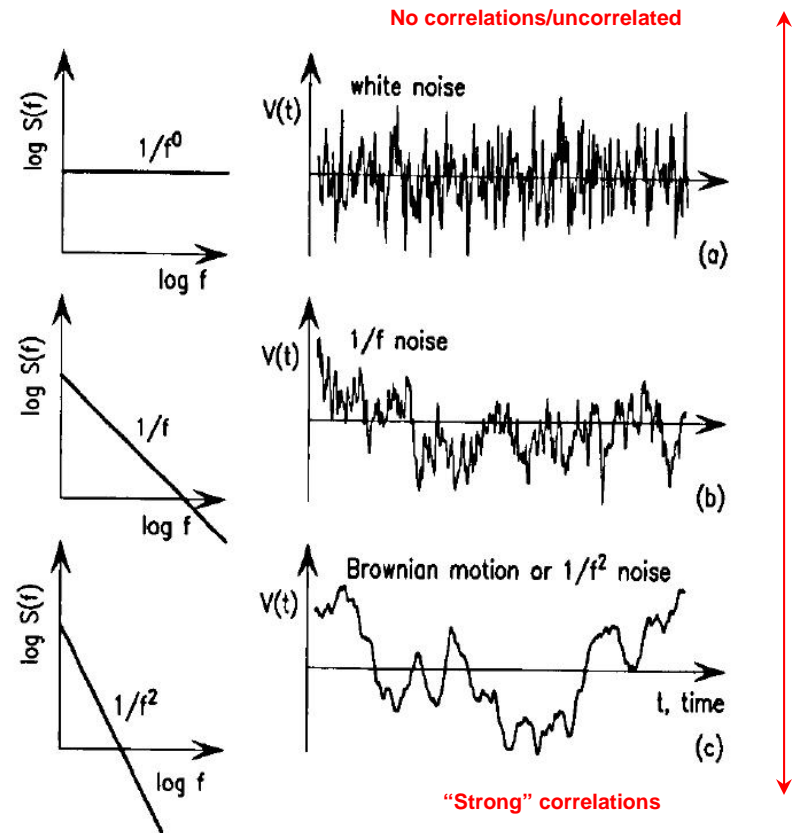
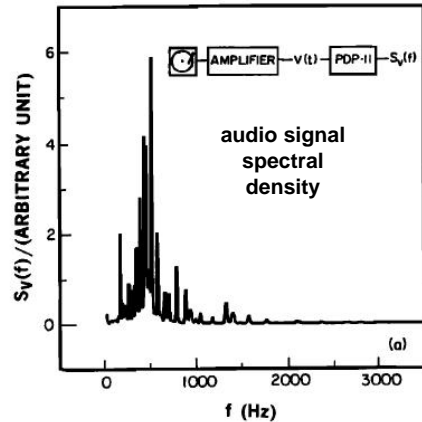

Fig. 3. Typical noises and their spectral densities $S_V(f)$.

R.F. Voss, “Random Fractals: Self Affinity in Noise, Music, Mountains, and Clouds”
Physica D 38, p. 362-371 (1989).

Does Human Music Exhibit 1/f-Type Fluctuations?

YES INDEED! 3 Possible ways: Amplitude, Frequency & Phase (Tempo)!



R.F. Voss and J. Clarke, "1/f noise in Music: Music from 1/f noise" J. Acoust. Soc. Am. 63, p. 258-263 (1978)

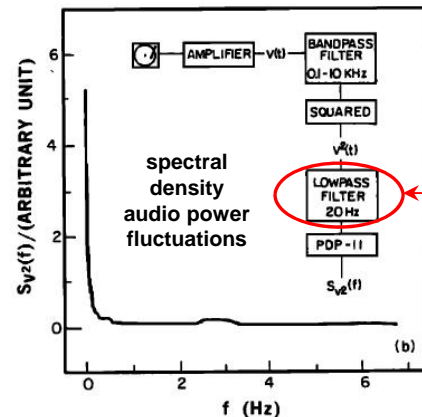

n.b. 20 Hz LPF smoothing unfortunately removed info associated with fluctuations on fluctuations...

FIG. 2. Bach's First Brandenburg Concerto (linear scales). (a) Spectral density of audio signal, $S_V(f)$ vs f ; (b) spectral density of audio power fluctuations, $S_{V^2}(f)$ vs f .

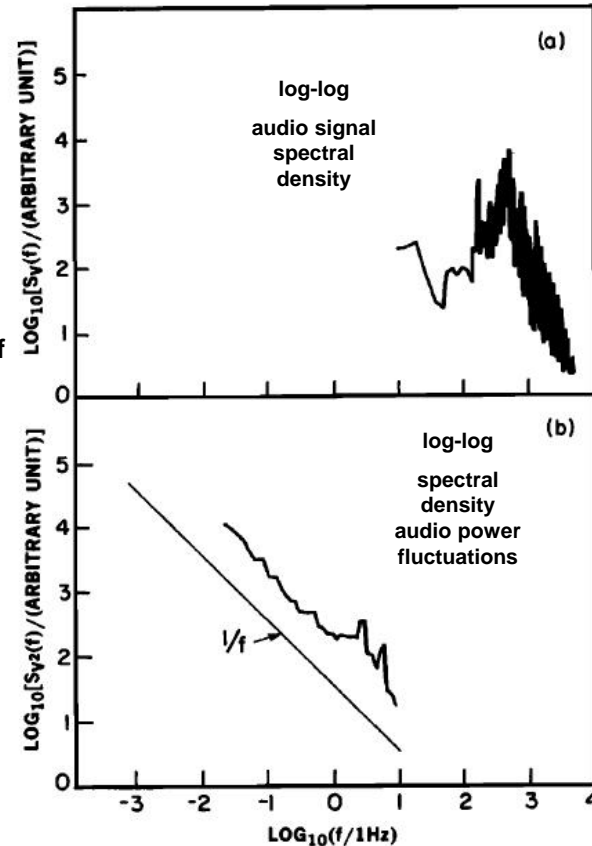

FIG. 3. Bach's First Brandenburg Concerto (log scales). (a) $S_V(f)$ vs f ; (b) $S_{V^2}(f)$ vs f .

Audio Power (Amplitude) Fluctuations:

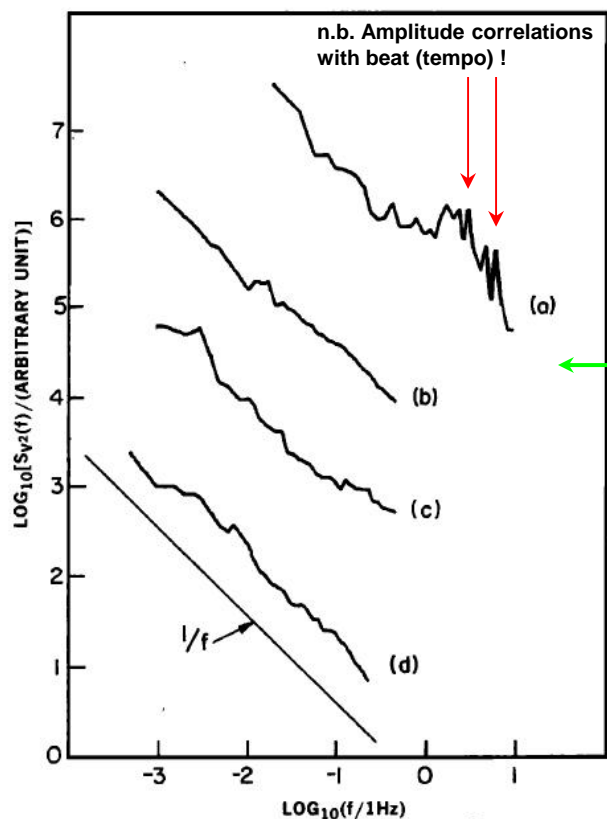

FIG. 4. Spectral density of audio power fluctuations, $S_{v^2}(f)$ vs f for (a) Scott Joplin piano rags; (b) classical radio-station; (c) rock station; and (d) news and talk station.

Consistent with $1/f^1$

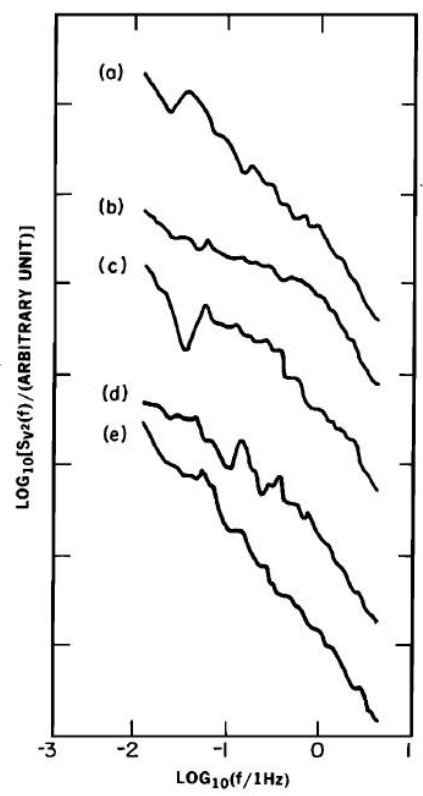

FIG. 6. Audio power fluctuation spectra densities, $S_{v^2}(f)$ vs f for (a) Davidovsky's Synchronism I, II, and III; (b) Babbitt's String Quartet number 3; (c) Jolas' Quartet number 3; (d) Carter's Piano concerto in two movements; and (e) Stockhausen's Momente.

Frequency Fluctuations:

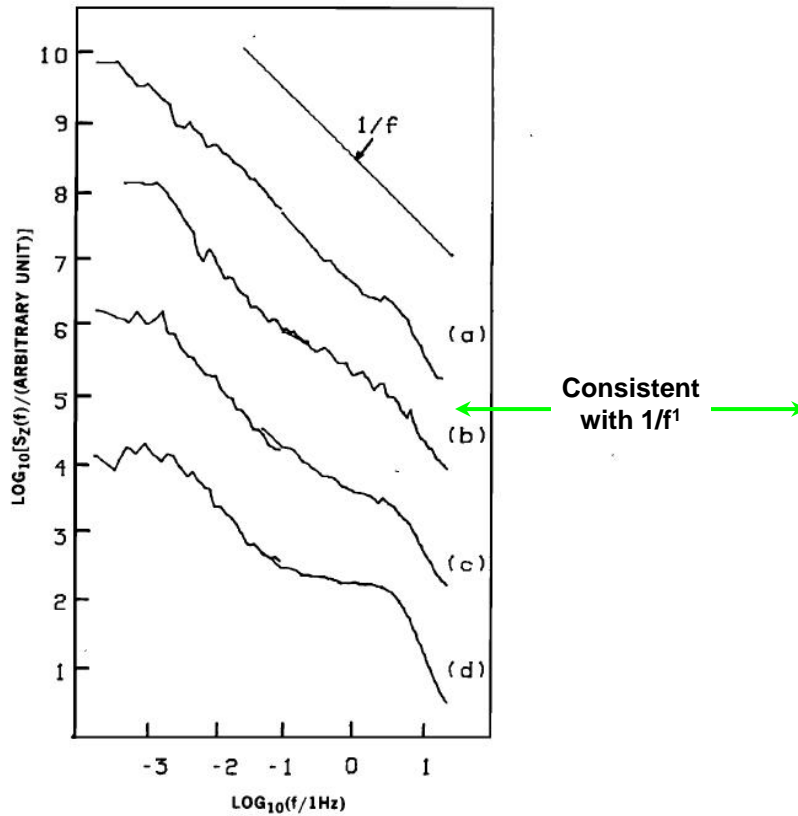

FIG. 5. Spectral density of frequency fluctuations, $S_z(f)$ vs f for four radio stations (a) classical; (b) jazz and blues; (c) rock; and (d) news and talk.

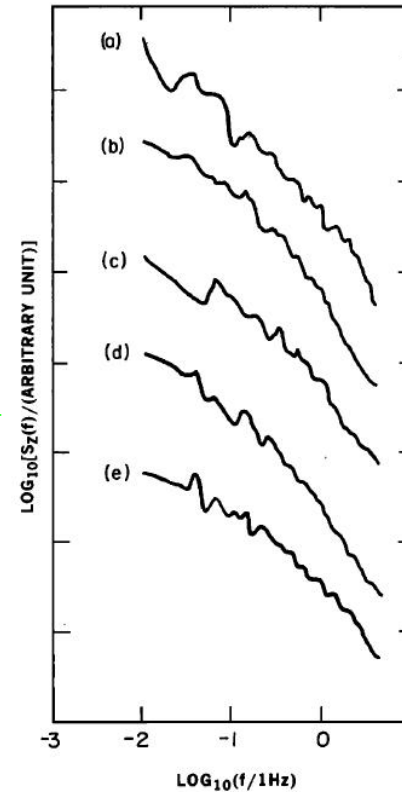

FIG. 7. Frequency fluctuation spectral densities, $S_z(f)$ vs f for (a) Davidovsky's Synchronism I, II, and III; (b) Babbit's String Quartet number 3; (c) Jolas' Quartet number 3; (d) Carter's Piano concerto in two movements; and (e) Stockhausen' Momente.

Frequency Fluctuations:

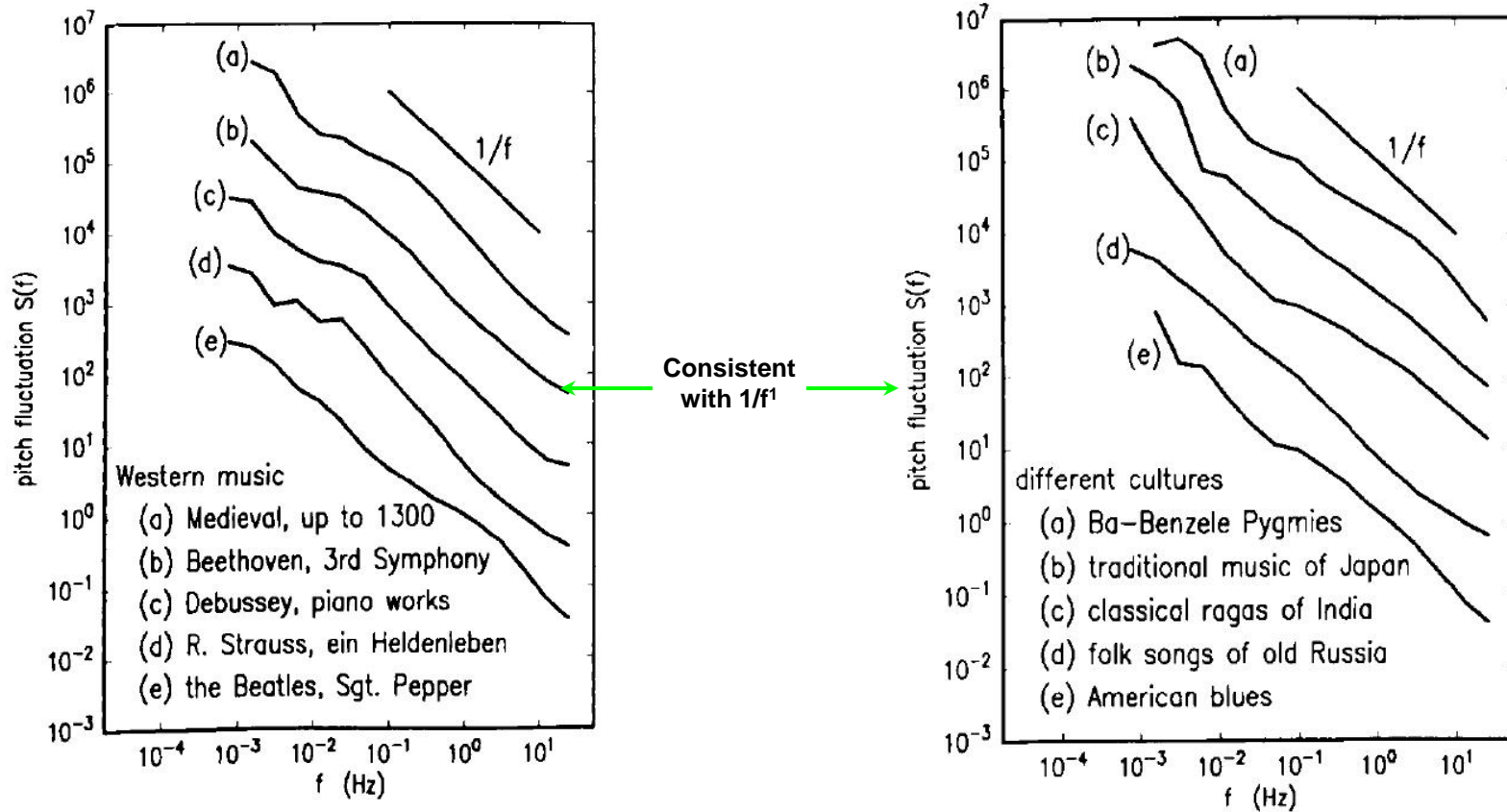
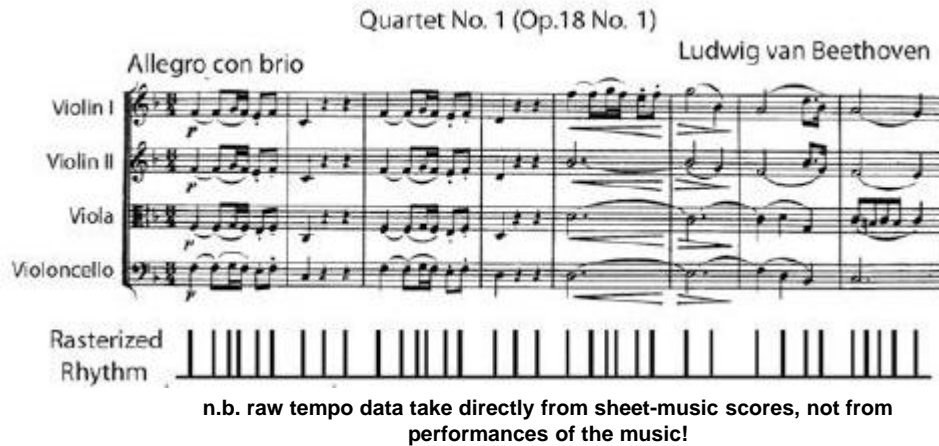

Fig. 4. Melody fluctuation spectral densities.

R.F. Voss, "Random Fractals: Self Affinity in Noise, Music, Mountains, and Clouds" *Physica D* 38, p. 362-371 (1989).

Tempo (Phase) Fluctuations:



D.J. Levitin, P. Chordia, V. Menon, “Musical Rhythm Spectra From Bach to Joplin Obey a 1/f Power Law”
www.pnas.org/cqi/doi/10.1073/pnas.1113828109

Used a multi-taper spectral analysis algorithm {commonly used in estimation of spike trains in neurobiology datasets} to analyze tempo data associated with past ~ 4 centuries of {western} music, totaling ~ 1800 movements from ~ 560 compositions across 16 sub-genres of human music...

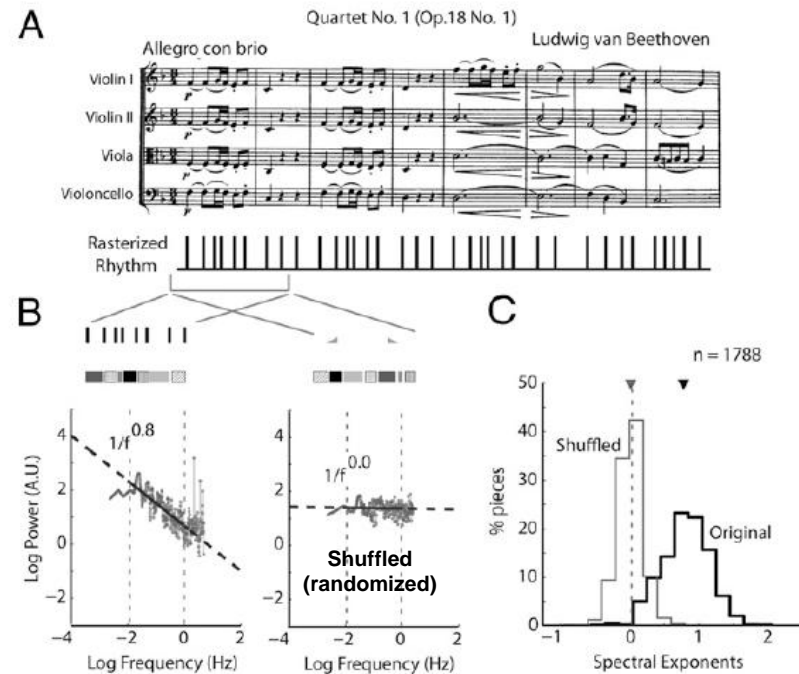

Fig. 2. Musical rhythm spectra obey a $1/f$ power law. (A) Rasterized rhythm representation (*Lower*) showing note onsets extracted from Beethoven's Quartet Op. 18, No. 1 (score, *Upper*). The representation shown is schematic: actual durations were extracted from the Humdrum kern format (*Materials and Methods*). (B) (*Left*) The spectrum of the rhythm raster from A has power that decays linearly (in a log-scale) with frequency as $1/f$ (gray dots). The slope of the spectrum (spectral exponent or β) is 0.8. Colored segments show the sequence of durations (internote intervals). Black line represents the linear fit to the spectrum in the frequency range of 0.01 to 1 Hz (delineated by dotted vertical gray lines). Dashed line represents extrapolation of the linear fit to other frequencies. (*Right*) The spectrum of a sequence with the note onsets shuffled randomly, keeping durations intact. The shuffled spectrum is flat ($\beta = 0.0$). Other conventions are as shown (*Left*). (C) Distribution of rhythm spectral exponents pooled across genres (black) obtained by linear fits to individual pieces across the population of 1,788 pieces analyzed. Gray: spectral exponent distribution for the corresponding shuffled rhythms. Inverted triangles represent the distribution median. Dashed vertical line: $\beta = 0$.

Tempo (Phase) Fluctuations – Different Types/Genres of Music:

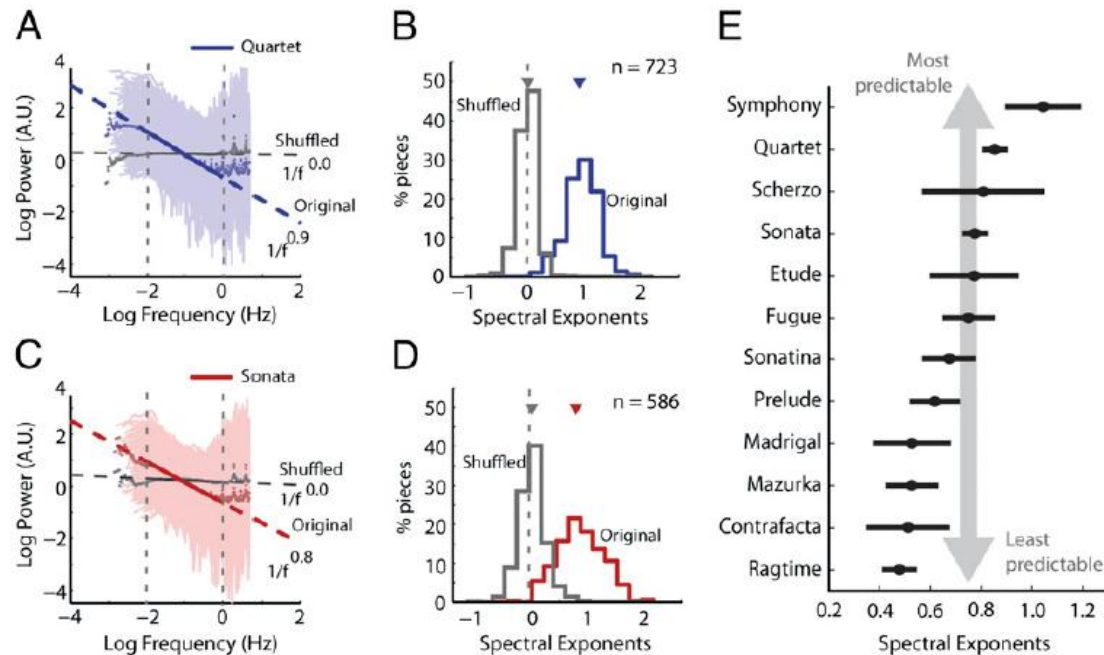

Fig. 3. The $1/f$ rhythm spectra are ubiquitous across genres. (A) Rhythm spectra for quartets. Average spectra (dark blue points) and linear fit (dark blue) to average spectrum in the frequency range of 0.01 to 1 Hz. Faded blue lines represent spectra of individual pieces. Gray data represent spectra of shuffled rhythms. Other conventions are as in Fig. 2B. (B) Distribution of rhythm spectral exponents obtained by linear fits to individual pieces (blue), and for the corresponding shuffled rhythms (gray). Inverted triangle represents median exponents. Dashed vertical line: $\beta = 0$. (C) Rhythm spectra for sonatas (red) and corresponding shuffled rhythms (gray). Other conventions are as in A. (D) Distribution of rhythm spectral exponents for sonatas (red) and corresponding shuffled rhythms (gray). Other conventions are as in B. (E) Distribution of rhythm spectral exponents for musical genres ordered from largest mean exponent to smallest. Larger exponents indicate correlations over longer timescales, and hence more predictable rhythms (vertical gray arrow). Circles are mean exponents, and error bars are 95% CI. Disjoint intervals indicate significantly different mean exponents (Tukey–Kramer HSD).

Tempo (Phase) Fluctuations – Different Composers:

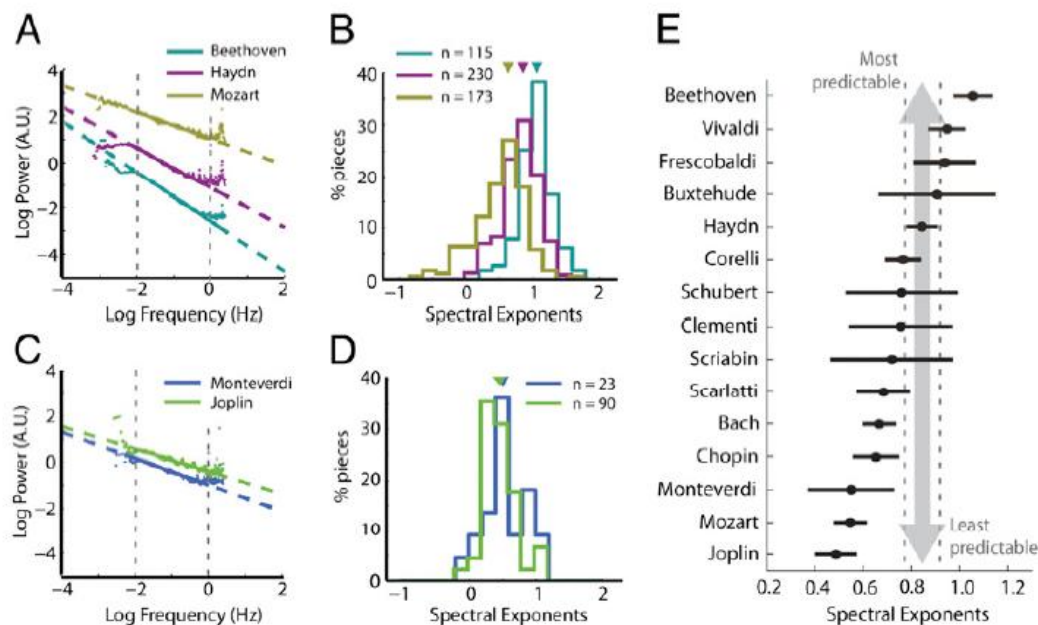

Fig. 4. Composers exhibit distinct $1/f$ rhythm spectra. (A) Average rhythm spectra for Beethoven (dark green), Haydn (violet), and Mozart (olive green): contemporary composers belonging to the Classical era (1750–1820). Other conventions are as in Fig. 3A. (B) Distribution of rhythm spectral exponents for compositions of Beethoven, Haydn, and Mozart. Color conventions are as in A. Other conventions are as in Fig. 3B. (C) Average rhythm spectra for Monteverdi (blue) and Joplin (green): composers separated by nearly three centuries of compositions. Other conventions are as in Fig. 3A. (D) Distribution of spectral exponents for compositions of Monteverdi and Joplin. Color conventions are as in C. Other conventions are as in Fig. 3B. (E) Distribution of spectral exponents for composers ordered from largest mean exponent to smallest. Spectral exponents of Haydn, for example (dotted vertical lines, 95% CI), are significantly different from those of Beethoven and Mozart ($P < 0.05$, Tukey–Kramer HSD). Other conventions are as in Fig. 3E.

⇒ It would be ***extremely*** interesting to carry out amplitude/frequency/tempo fluctuation analyses e.g. on ***whale*** songs and also songs from ***other*** singing animals! Do they ***also*** have $1/f^\beta$ structure??

⇒ Could potentially give us additional insight(s) as to what ***alien*** music (if exists) might sound like...

Turn the Physics Around – Generate “Music” from $1/f^\beta$ “Noise”!



Fig. 5. Samples of stochastically composed fractal music based on the different types of noises shown in fig. 3. (a) “White” music is too random; (b) “ $1/f$ ” music is the closest to actual music (and most pleasing) and (c) “brown” or $1/f^2$ music is too correlated.

Fluctuations of Fluctuations in Computer-Generated $1/f^\beta$ music:

A.) perfect beat/tempo
 $\tau = \text{constant}$
(least preferred)

B.) $1/f^0$ white noise fluctuations in beat/tempo
(better)

C.) $1/f^1$ noise fluctuations in beat/tempo
(best/most preferred!)

We humans appreciate / enjoy (some degree) of complexity in our music !!!

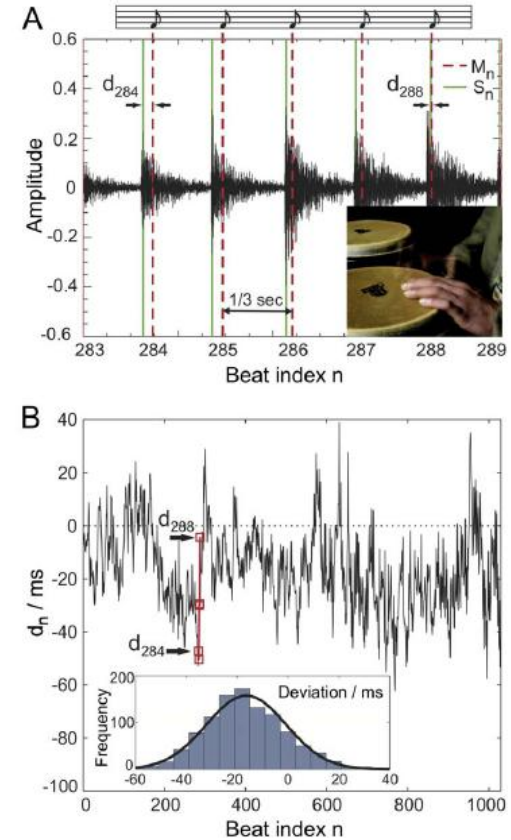

Figure 1. Demonstration of the presence of temporal deviations and LRC in a simple drum recording. A professional drummer (inset) was recorded tapping with one hand on a drum trying to synchronize with a metronome at 180 beats per minute (A). An excerpt of the recorded audio signal is shown over the beat index n at sampling rate 44.1 kHz. The beats detected at times S_n (green lines, see Methods) are compared with the metronome beats (red dashed lines). (B) The deviations $d_n = S_n - M_n$ fluctuate around a mean of -16.4 ms, i.e. on average the subject slightly anticipates the ensuing metronome clicks. Inset: The probability density function of the time series is well approximated by a Gaussian distribution (standard deviation 15.6 ms). Our main focus is on more complex rhythmic tasks, however (see Table 1). A detrended fluctuation analysis of $\{d_n\}$ is shown in Fig. 2C (middle curve). doi:10.1371/journal.pone.0026457.g001

Musicians have fractal $1/f$ -noise in playing the actual music! Neural noise!
We humans (definitely) prefer this!

The Musicality of a Chaotic “Leaky” Water Faucet

It has been extraordinarily difficult/frustrating to find/locate period-doubling/bifurcation critical water flow-rate point(s) using visual information of water drop time-differences from an oscilloscope trace...

Convert time differences between successive water drops into audio frequencies – sounds like jazz music !!!
 The human ear + brain makes it “trivial” to locate these bifurcation points! From the immediately previous slides, now we understand why!



UIUC Physics 406 Chaotic “Leaky” Water Faucet Experiment

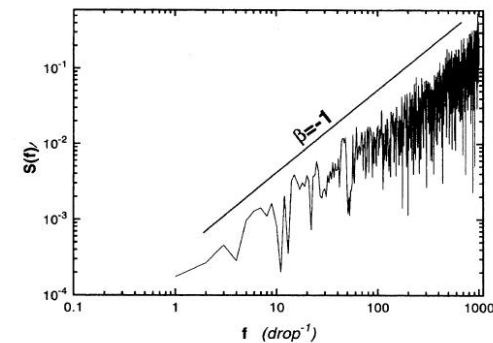
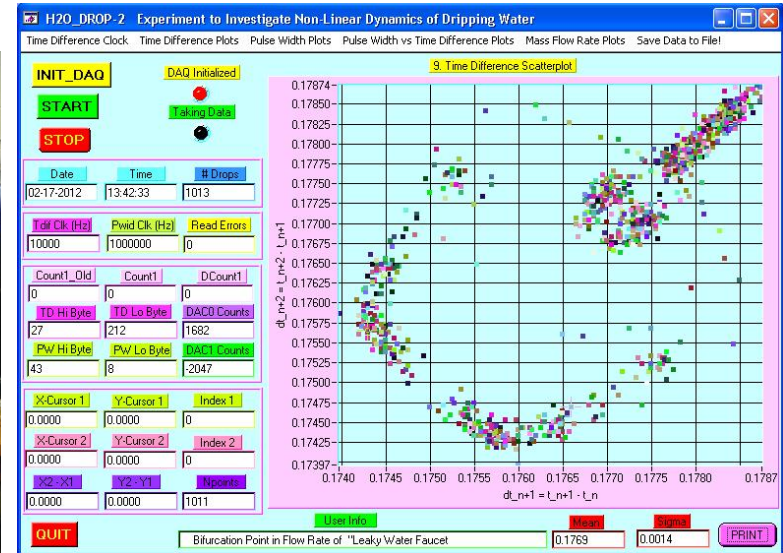
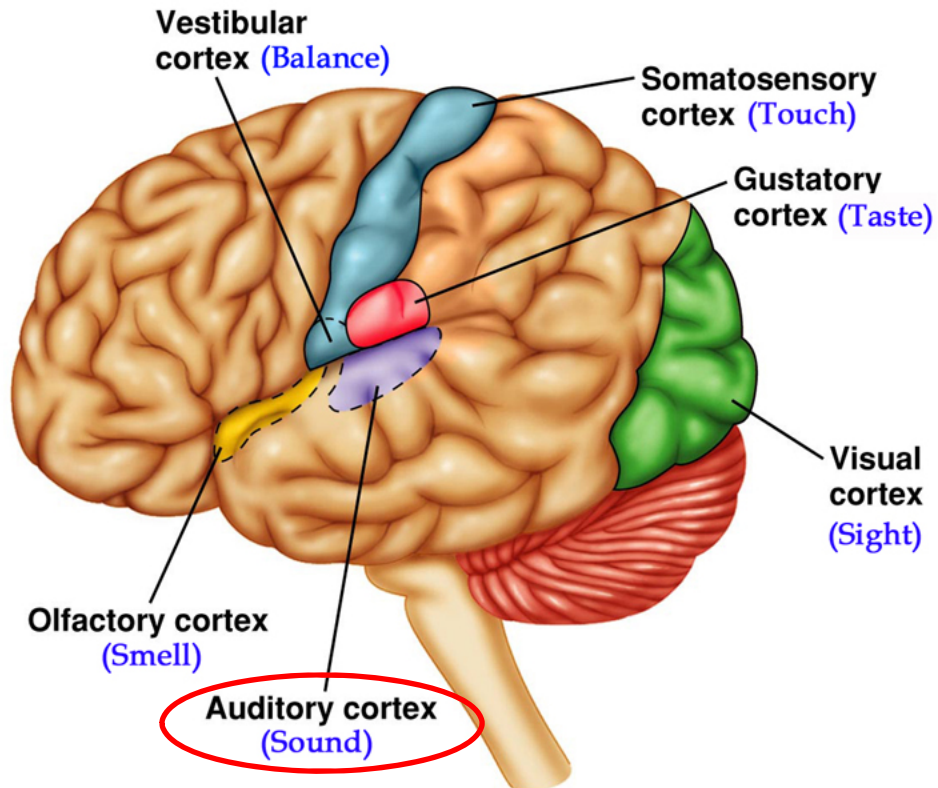

FIG. 4. Power spectra $S(f)$ for the interval increments for the time series presented in Fig. 1. A straight line corresponding to the $\beta = -1$ curve is presented for comparison.

Basic Sensory Organization of the Human Brain:



Copyright © 2008 Pearson Education, Inc., publishing as Benjamin Cummings

Regions of the Human Brain Associated with Music:

Outside:

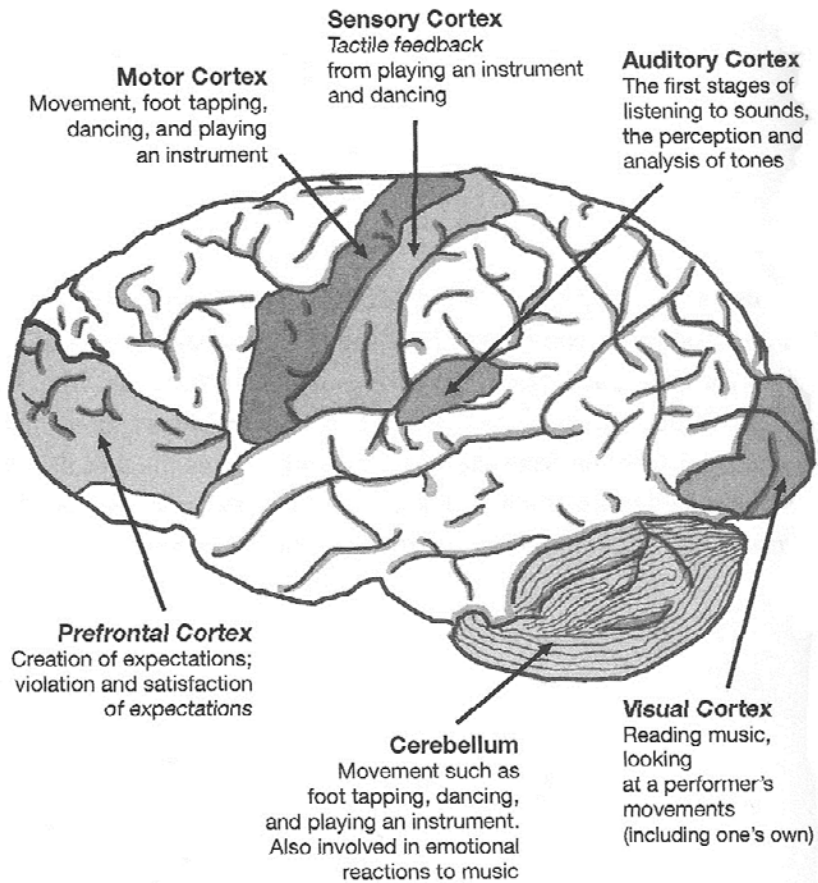

Inside:

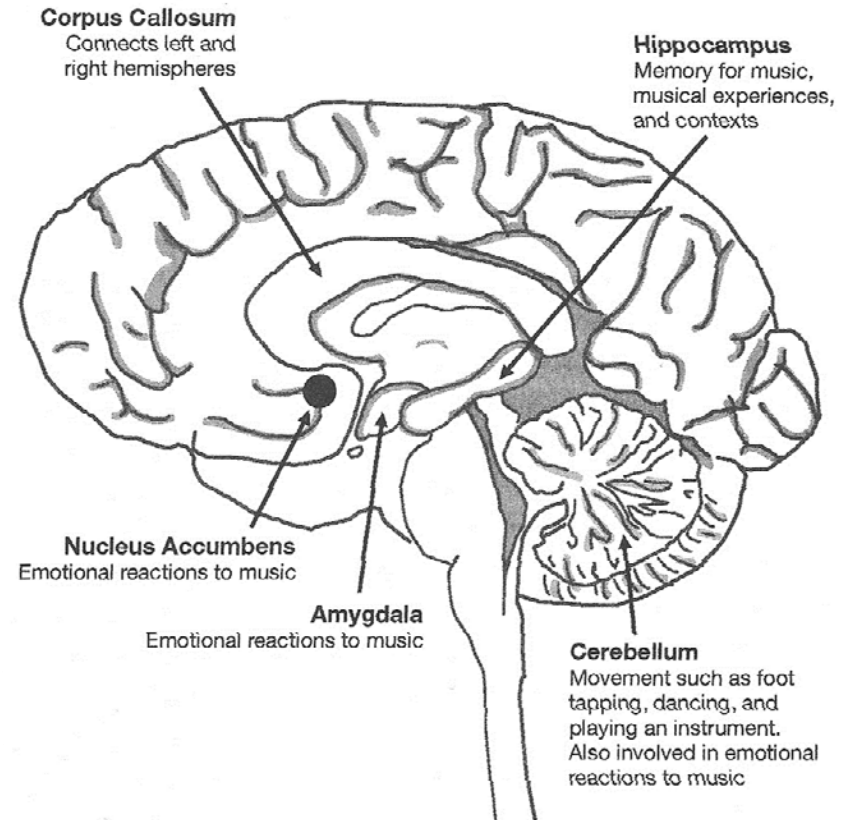

Tonotopic organization of the human auditory cortex – fMRI scans – pitch discrimination circuitry is geometrically laid out in ascending order – like keys on a piano!

24

D. Bilecen et al. / Hearing Research 126 (1998) 19–27

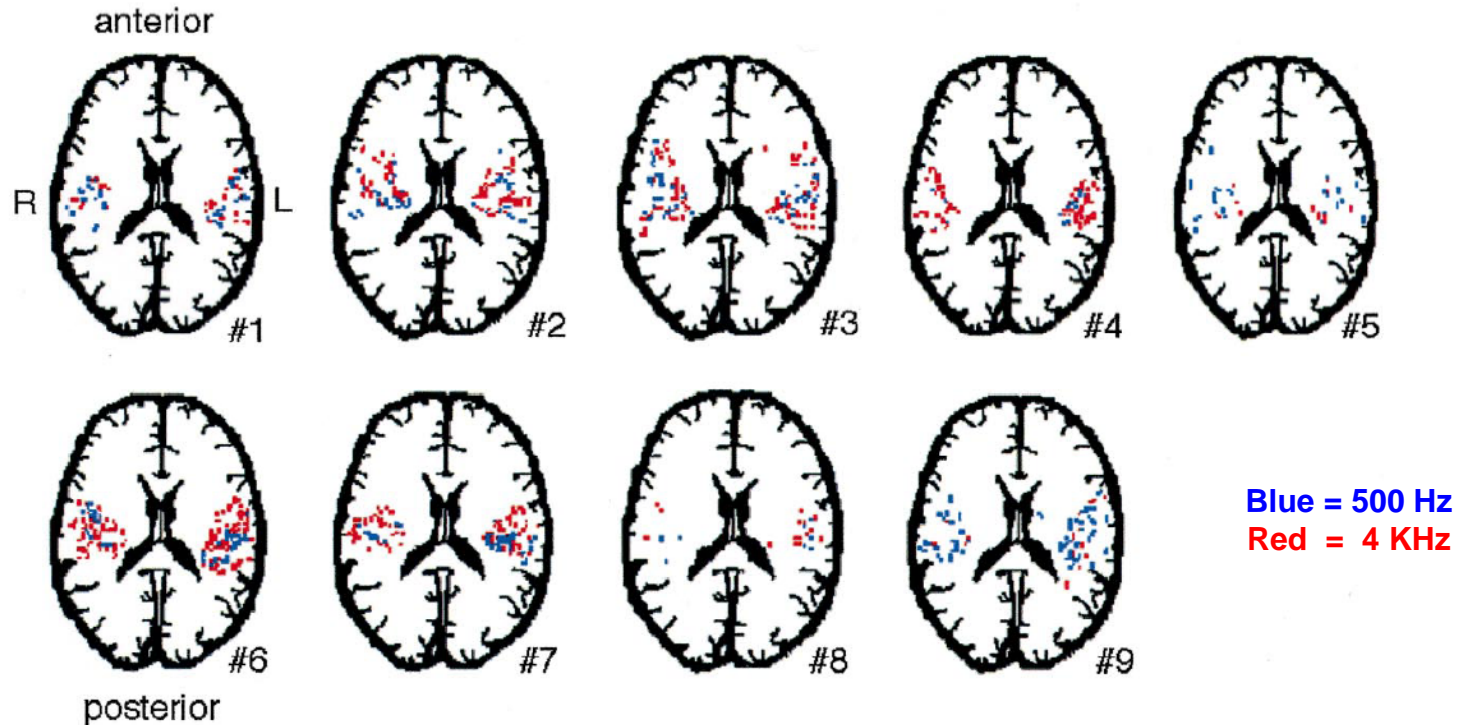
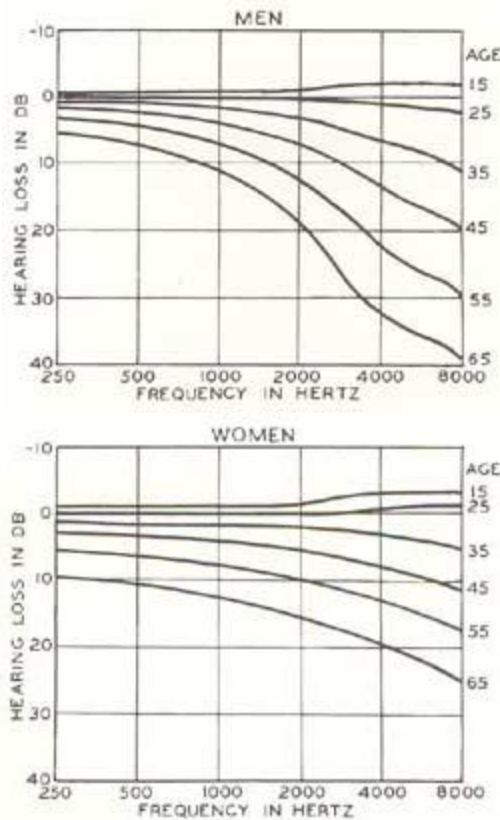

Fig. 5. Activated pixels in axial projection of all nine subjects. Blue pixels represent 500 Hz and red pixels 4000 Hz tone activated areas. All functional images were imposed on a schematic sketch. In general, high tone areas are located more frontally and closer to the medio-sagittal plane than the low tone activated areas.

“Natural” hearing loss as we age – worse for men than for women; Can also be cause for tinnitus – the brain apparently generates “spurious” signals...



fMRI studies: Tonotopic reorganization of the auditory cortex in tinnitus:

10342 Psychology: Mühlnickel *et al.*

Proc. Natl. Acad. Sci. USA 95 (1998)

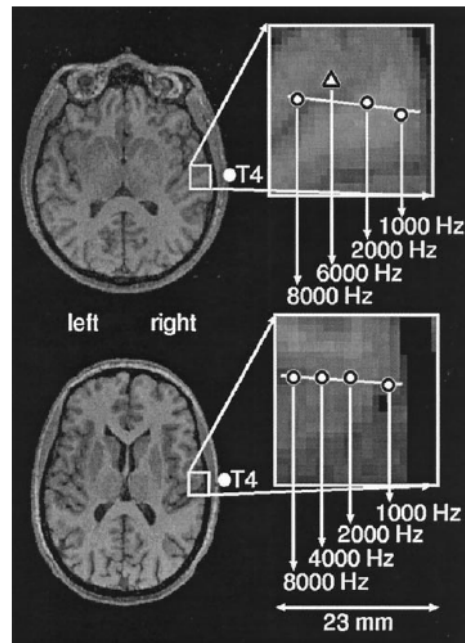

FIG. 1. A typical example of the tonotopic map is shown for a left ear tinnitus (*Upper*) and a control subject (*Lower*). Equivalent current dipoles elicited by auditory stimulation at the three standard and the tinnitus frequency in the tinnitus subject and the four standard frequencies in the healthy control are superimposed onto an axial slice of Brodmann's area 41 of the right hemisphere. The line in the upper portion of the figure shows the trajectory of the dipole locations of the three standard tones (circles). The triangle (*Upper*) represents the location of the tinnitus frequency (6,000 Hz in this case). Note that the trajectory of the dipole locations of the four standard frequencies in the healthy control subject (circles, *Lower*) is linear, whereas the dipole of the affected frequency in the tinnitus subject diverges from the linear trajectory established by the three standard frequencies. The location of T₄ as well as the scale of measurement are marked.

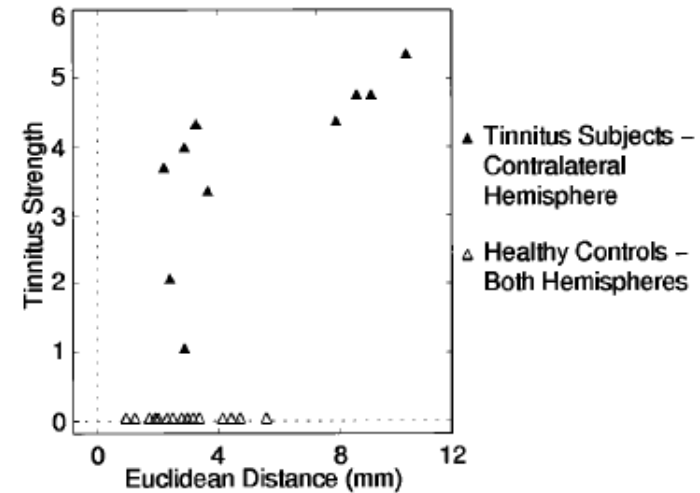

FIG. 2. Scatterplot of amount of subjective tinnitus strength and deviation of the tinnitus frequency from the tonotopic map in the contralateral hemisphere. A measure of deviation of the tinnitus frequency was obtained by determining the Euclidean distance between the trajectory of the standard tones and the location of the tinnitus frequency in tinnitus subjects or the corresponding comparison frequency in control subjects (see text). The tinnitus strength was assessed by the MTL. Greater subjective tinnitus strength was related to larger deviations from the trajectory of the standard frequencies. This figure suggests that there might not be a linear relationship between tinnitus and reorganization but rather a bimodal distribution of tinnitus sufferers with and without map distortions. The size of the sample studied is too small to clarify this point.

Music and the Human Brain:

Music is processed simultaneously in multiple regions of our brain – sequentially and in parallel – for frequency, amplitude/loudness, tempo/beat/rhythm, contour, as well as e.g. recalling memories of the same song and/or related songs – stored in several places in the brain – not just one place... explains why we have very robust recall of music! Alzheimer's patients remember songs/song lyrics long after forgetting everything else....

The outputs of these sound/music processing centers are also wired into our emotional centers in our brains – music can make us feel happy/sad/...

Various brain chemicals/neuro-transmitters are produced when listening to/participating in music:

Serotonin – produced by neurons of the raphe nuclei in the brain stem {regulates mood, appetite, sleep & metabolism}

Dopamine – released in nucleus accumbens {regulates emotions, mood, alertness and coordination of movement, aids in encoding of memory, and is also part of brain's pleasure and reward system – e.g. gamblers/drug addicts/chocoholics}. Its role in music was only recently discovered (V. Menon, D.J. Levitin, *NeuroImage* 28(1): 175-84, 2005).

Oxytocin – released by the pituitary gland, amygdala, ventromedial hypothalamus, septum and brain stem during communal singing, rituals & sexual arousal, enhances bonding & trust, reduces fear and/or apprehension, affects generosity by increasing empathy, ... Its role in music was also only recently discovered {1995, 2003, 2005}.

Endorphins – released by the pituitary gland & hypothalamus during singing, strenuous exercise, pain, orgasm, death – resembles opiates in analgesic (painkiller) ability and produces a sense of well-being...

Music increases our alertness – via modulation of norepinephrine and epinephrine (*aka adrenaline*)...
Music also ameliorates the effects of stress – reduces cortisol levels (a hormone produced by stress).

The release of “feel-good” neuro-chemicals in human brain in response to playing / listening to music points to an ancient and evolutionarily beneficial connection to music, e.g. helps sooth/ease tensions/smooth over differences/forgo social bonds/... helps to preserve/maintain/stabilize social structure of the group...

The release of these brain chemicals also boosts the immune system – humans stay healthier/fend off illness/disease – again improves the odds of one's survival!

Production of “feel-good” neurotransmitters human brains in response to music evolutionarily beneficial to humans – individuals who didn’t benefit from/have this response were at a disadvantage ⇒ reduced probability for passing on their genes. The humans who survived enjoyed/benefitted from music! ← “positive” feedback mechanism!

Social interactions of early prehistoric tribes very likely coupled music, dance, food, celebration – benefitting everyone in group, also helping to ease tensions/squabbles, etc. – maintain stability of social structure of group...

Robust memory of music/song ⇒ effective tool e.g. for education of young – worldly do’s n’ don’t’s, how-to’s, etc. and also oral/musical preservation of early human culture’s history...

n.b. written language developed only “very recently” (~ 6000 years ago – @ transition from hunter-gatherer to agrarian societies – to keep track of transactions of goods, etc. between members of society in that era...)

Earliest music presumably utilized only the human voice & e.g. clapping of hands, stomping of feet, etc. ⇒ naturally led to development of musical instruments such as early flutes, drums, etc. to accompany & thereby enhance such activities/ceremonies...



Early humans:

Likely entire group participated in music & dance celebrations...

Tradition still carried on today in many indigenous / native groups...

Mirror Neurons

- **Mirror neuron = neuron that fires both when animal performs an action and when animal observes the same action by another {similar} animal.**
- **The neuron “mirrors” the behavior of the other animal, as though the observer were itself performing the action!**
- **Exist in the brains of humans, primates and also certain birds (e.g. Zebra Finch)**
- **Important for understanding the actions & intentions of others?**
- **Enables us to experience empathy for/understanding of others?**
- **Important for imitation & learning new skills?**

A newborn
macaque
monkey
imitating a
human facial
expression:



- **Important for language acquisition?**
- **Important for learning in general? ← Incorporate this info into our teaching methods!**
- **Provides the physiological mechanism for perception-action coupling?**
- **Activate e.g. when watching movies, people playing sports games, performing music, ... e.g. many musicians listen just once to a new music composition and then perform it...**
- **Helps form/define the basis for a species' social behavior?**
- **Responsible for self-awareness/consciousness?**
- **Dysfunction/deficiency of mirror neurons – associated with autism?**

Genes for Language and Music:

Examination of fossil skulls reveals that Brodmann area 44 (BA44) – part of the frontal cortex {important for cognitive and perceptual tasks, as well as auditory motor imitation via mirror neurons} may well have been in place ~ 2 Myrs ago (i.e. long before Homo sapiens – first emerged ~ 200 Kyrs ago).

⇒ Neural mechanisms for *language* were in place long before they were fully exploited...

The FOXP2 gene (located on chromosome 7) is closely associated with human language – also existed in Neanderthals {recent DNA analysis!}. Chimpanzees and songbirds, such as the Zebra Finch {as well as other animals - e.g. fish, mice, crocodiles,...} have their own versions of the FOXP2 gene.

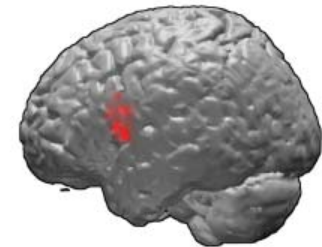

Brodmann area 44

Microcephalin is part of the human genome that encodes for brain development. A genetic variant of this gene emerged ~ 37,000 years ago – i.e. at the beginning of culturally modern humans, and coincides with the emergence of tonal languages and the appearance of artistic artifacts and bone flutes... →

A second genetic variation of microcephalin arose ~ 5,800 yrs ago – coincides with the first record of written language, spread of agriculture, development of cities, ...

n.b. Social interactions can/do alter gene expression in the brain {and vice versa}!

⇒ ramifications for evolutionary forces operative in today's modern world???

The earliest {unambiguously} known musical instrument – ivory flute (made from woolly mammoth tusk) found in a mountain cave {Geissenklösterle}, near Ulm, in southwestern Germany in 2004, ~ 37,000 years old, and is ~ 18.7 cm long:

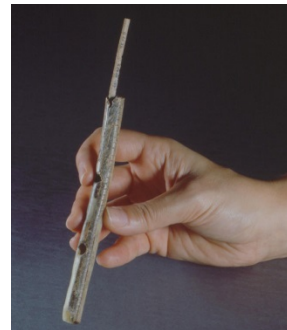

n.b. other flutes (made from swan bones) discovered earlier in same cave;

A bone drumstick has also found in this cave....

2nd Bone Flute (Griffon vulture, > 35K yrs old) recently found in cave near Hohle Fels (SW Germany) in 2008:



n.b. An exact copy of this flute was made (via laser scan \Rightarrow 3-D printing), given to professional musician, who, after learning how to play it, was able to play “Amazing Grace” on it (key of D - uses the white notes on piano) and the German National Anthem – (uses both the white and black notes on piano) !!!

\Rightarrow Evidence for 12-note natural/“consonant” musical scale in existence at that time, ~ 30,000 years before the Greeks !!!

\Rightarrow Presumably this flute was not a prototype !!!

July 31, 2013

UIUC NSF REU POM Talk

48

Connection Between Prehistoric Art and Music in Palaeolithic Caves:

Grotte du Peche Merle (Blackbird Hill), Caberets, Departement Lot, Southern France

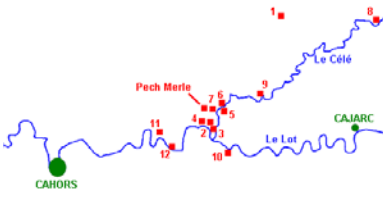
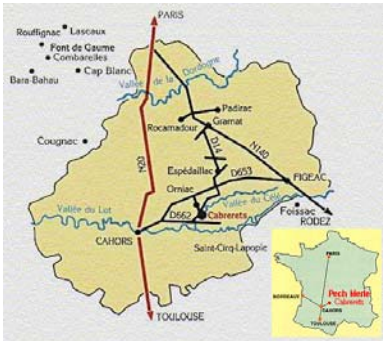

Paintings dated ~ 20,000 – 25,000 yrs old ⇒

Caves were a good place to live / camp out in during the last glacial period:

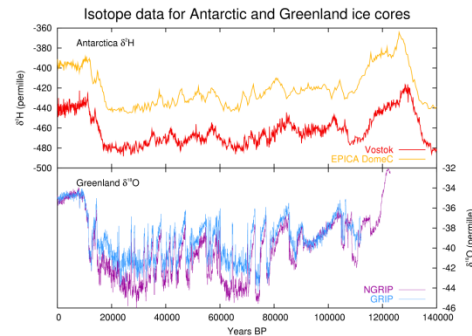

Red dots are markers for acoustic resonances !!!

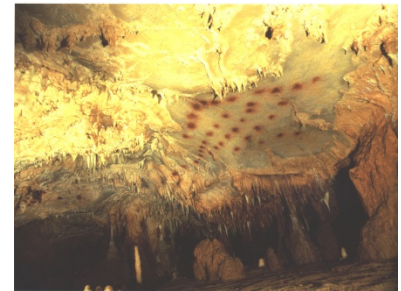

La Grotte du Portel, Ariège Pyrenees, Southern France:

Acoustical resonance properties of this cave recently studied by Prof. Igor Reznikoff & his University Paris/Nanterre research team.



Paeleolithic man would have explored caves by dull light of torches, and using his voice like sonar/echo-location to navigate around corners, avoid holes, explore nooks/crannies of the cave...

Reznikoff's team discovered that the red dots in this cave were markers of acoustic resonances – and were very often within ~ 1-2 meters of paintings in the cave.

Brought in trained vocalist to map out the acoustic resonances.

Also discovered that by modulating the harmonic content and amplitude, some acoustic resonances sounded very similar to those made by the animals painted on the nearby wall – i.e. animal paintings also a marker for humans to make the animal's sound !!!

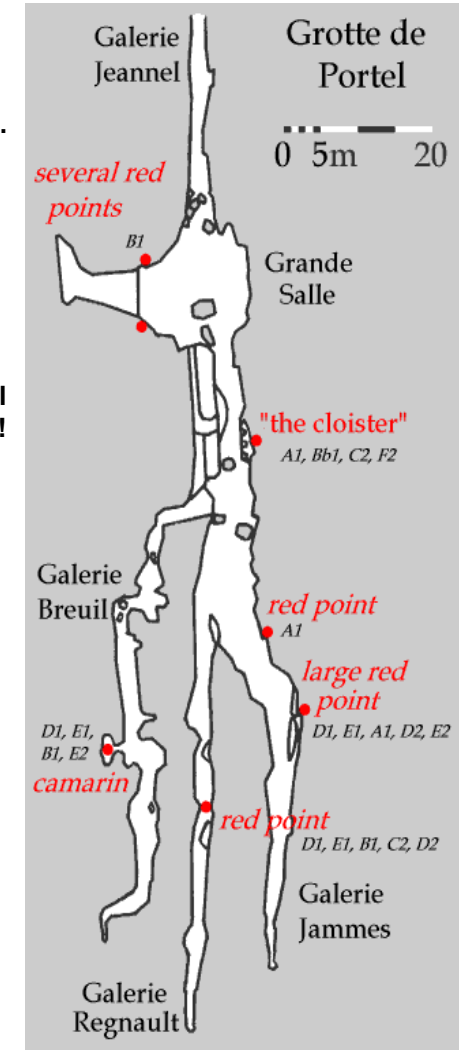

From the perspective of “survival of the fittest”, all animals living on our planet are fundamentally / primarily interested in their own species, and secondarily in other species (e.g. as food/keep from becoming food...)

We humans are no different in this regard. Our anthropocentric view of interest primarily in our own species is also reflected in our music - e.g. consonant intervals, musical scales, etc. as well as the sounds made by musical instruments that we have developed over the millennia....

It is absolutely not an accident that our musical instruments mimic the human voice – i.e. 1-D vibrating systems with integer-related harmonics $\{f_n = nf_1\}$ for overtones – some musical instruments succeed in this more closely than others, which can be viewed as ~ artistic abstractions of the human voice. Skilled musicians playing such instruments can evoke in us strong emotions as if we were listening to a human in agony/pain, joy/ecstasy, sorrow, etc. Tempo/timing – which parallels the temporal aspects of various human gestures/movements recently found to be critical in this regard, in terms of evoking human emotion(s) in response to music!

Similarly, it is also not an accident that {anharmonic $f_n \neq nf_1$ } 2-D percussion instruments – drums etc. are used to mimic the impulsive sounds associated with internal human rhythms – e.g. our heart beat, blood pulsing through our veins, breathing, etc.

Both classes {1-D and 2-D} of musical instruments can also be/have been used in musically artistic ways to mimic the voices, etc. of animal species that are of secondary interest to us – e.g. the singing of birds, the roar of lions, howling of wolves, the clip-clop of horses hooves, etc.



A Test of My Own Long-Term Musical Memories:

I played {electric} guitar in mid-60's – mid-70's; started playing again in ~ mid-90's:
 “Faithful” modern-day re-issues of vintage guitars didn't sound like the real deal to
 my ears... Due to false memories, or actual truth??? I explicitly checked:

Gibson P-90's in Les Pauls, Les Paul Jr, ...

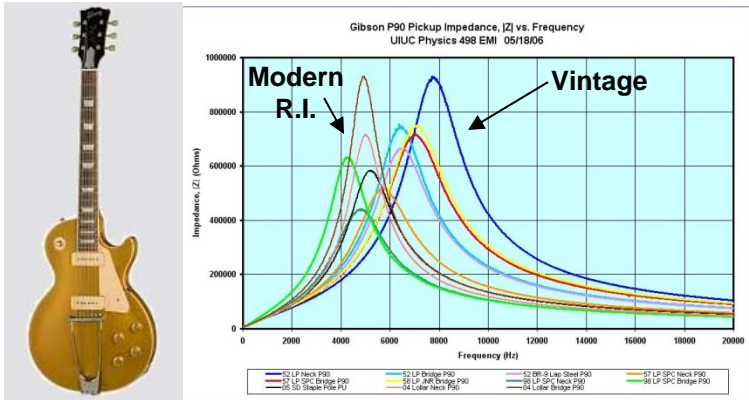

Fender Stratocaster Pickups

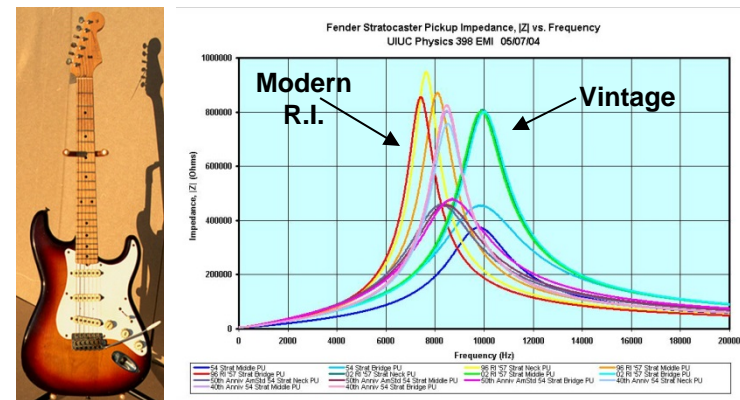

X-ray of P-90 PUs from '52 (top) vs. '98 R.I. (bottom) Gibson Les Paul Guitars:

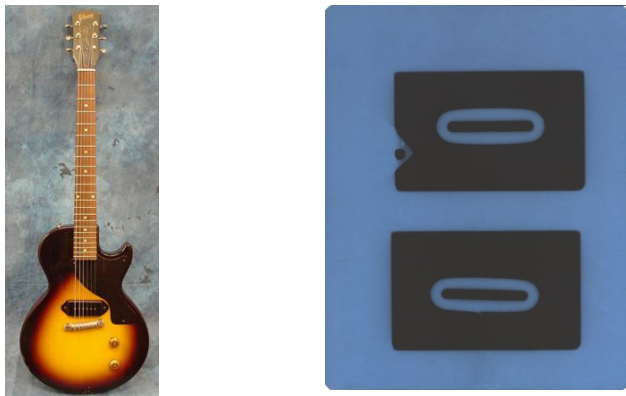

Gibson Firebird Pickups

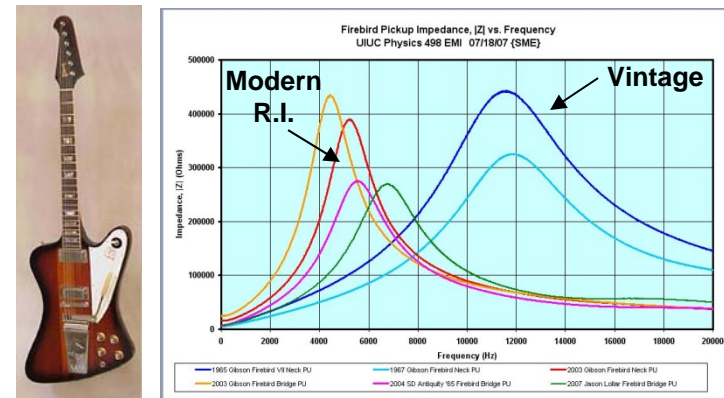

Some Closing Comments:

⇒ **Nature vs. Nurture:** Infants & young children (< 8 yrs) undergo enormous development in their brains – literally wiring the connections in their brains in a myriad of ways. Children deprived of sight/vision for any significant length of time (e.g. due to eye infection) are at risk of life-long adverse impact because of this... Presume similar/analogous adverse effect(s) will occur if children grow up in environment completely *devoid* of all music – those brain areas not used for nominally the processing of music will be wired for other uses... Will we eventually lose our “musical roots”? {e.g. Our bodies have lost the ability to internally produce vitamin C because of eating fruit in our diet – Our bodies still do produce other vitamins, e.g. vitamin D, etc...}

⇒ Importance of music in fostering development of our children, and synergy in their education! {n.b. For the UIUC POM courses, I have quite consciously/deliberately capitalized on the intrinsic human interest/enjoyment/pleasure in music – to get students excited about acoustical physics {& science in general} – it really works, amazingly well !!!}

⇒ Think about ramifications of/impact on societies whose leaders outright ban all music – e.g. the Taliban in Afghanistan...

⇒ Information Overload: What is the impact – *short* and *long-term* – on us humans (and other creatures – effects of our own noise pollution) living in the modern-day world, filling our heads 24/7 with overdoses of information & sounds coming at us seemingly from all directions, and at an ever-increasing pace? Think about this in terms of our biological origins... {will our heads explode at some point???) Human culture planet-wide is exponentially changing, far faster than human evolutionary time scales... what are long-term implications of this?

⇒ The development of new technologies {e.g. fMRI, DNA sequencing, ...} in multiple areas of research has led to many exciting discoveries in the past few years, in terms of us gaining a better understanding of the importance of music in our daily lives in the here-and-now, and how this all came about – i.e. our past – Why is our own musical memory so strong? *Did* music play an important evolutionary role in our development???

⇒ The current picture on this topic is far from complete... However, more and more people appear to be getting involved & investigating as more becomes known – the pace is accelerating.... The nature of this subject is such that it requires/would benefit greatly from multi-disciplinary research/collaboration...

⇒ *If* intelligent life exists elsewhere in the universe, would such beings *also* have music in *their* culture?

What would *their* music sound like? Did their music play an important role in *their* evolution?

Would their musical instruments also artistically mimic their own voices, their own internal rhythms?

⇒ Many, many things to think about, investigate & study!

⇒ We live in very exciting times in this regard {as well as many others}!

⇒ If you-all had really wanted to remember everything in this colloquium talk,

I should have sung everything to you, and we all should have danced!



“Malachy”

{Best In Show, 2012}

Men In Black 5 ???

If Interested: Suggested/Recommended Books for Further Reading:

- “*This is Your Brain on Music – The Science of Human Obsession*”, Daniel Levitin, Dutton, 2006.
- “*The World in Six Songs*”, Daniel Levitin, Dutton, 2008.
- “*The Singing Neanderthals – The Origins of Music, Language, Mind and Body*”, Steven Mithen, Harvard University Press, 2007.
- “*The Origins of Music*”, Nils Lennart Wallin, Björn Merker, Steven Brown, MIT Press, 2001.
- “*Musicophilia – Tales of Music and the Brain*”, Oliver Sachs, Alfred A. Knopf, Inc., 2007.

Website(s) for UIUC Physics of Music/Musical Instruments Courses (if interested):

Freshman “Discovery” Course: <http://online.physics.uiuc.edu/courses/phys193/>

Upper-Level Undergrad Physics Course: <http://online.physics.uiuc.edu/courses/phys406/>

Some Experimental Results from the UIUC Physics of Music/Musical Instruments Lab...

Phase-Sensitive Analysis of Sounds

Complex Sound Field Measurements

Fourier {aka Harmonic} Analysis of Periodic Waveforms:

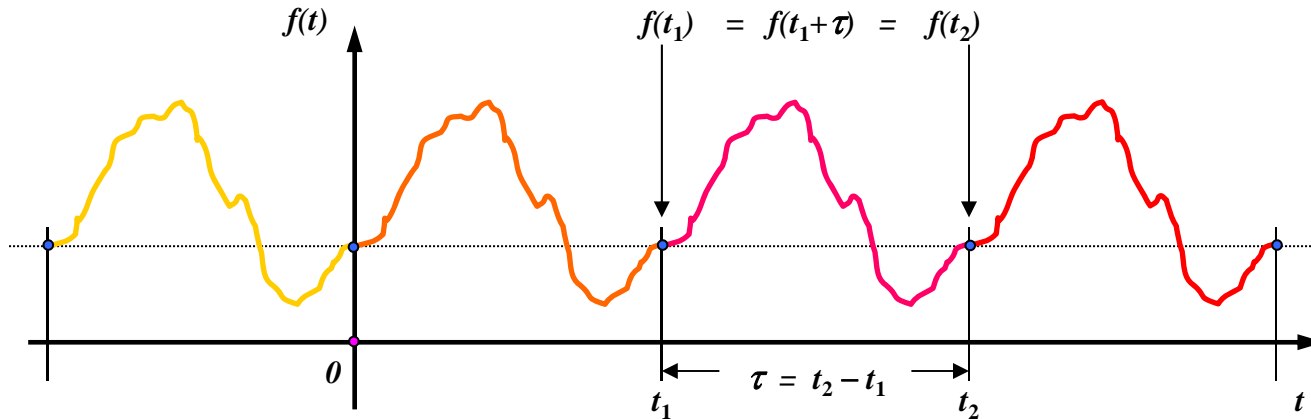

$$f(t) = a_o + \sum_{n=1}^{\infty} a_n \cos \omega_n t - \sum_{n=1}^{\infty} b_n \sin \omega_n t \quad (\omega_n = 2\pi f_n, \quad f_n = n f_1)$$

$$a_n = \frac{1}{\tau} \int_0^{\tau} f(t') \cos \omega_n t' dt' \quad b_n = \frac{1}{\tau} \int_0^{\tau} f(t') \sin \omega_n t' dt'$$

Define: $a_o \equiv c_o$ $a_n \equiv c_n \cos \varphi_n$ $b_n \equiv c_n \sin \varphi_n$ $\varphi_n = \tan^{-1}(b_n/a_n)$

$$f(t) = c_o + \sum_{n=1}^{\infty} c_n \cos(\omega_n t + \varphi_n) = \sum_{n=0}^{\infty} c_n \cos(\omega_n t + \varphi_n) \quad (\omega_o = \varphi_o \equiv 0)$$

$$c_n = \frac{1}{\tau} \int_0^{\tau} f(t') \cos(\omega_n t' + \varphi_n) dt'$$

Complexify: $\tilde{f}(t) = \sum_{n=0}^{\infty} c_n e^{i(\omega_n t + \varphi_n)}$ $c_n = \frac{1}{\tau} \int_0^{\tau} \tilde{f}(t') e^{i(\omega_n t' + \varphi_n)} dt'$

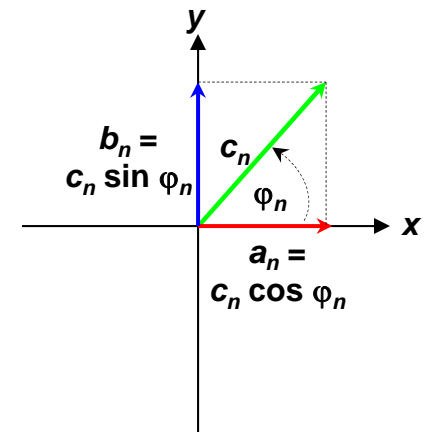

Harmonic Content of “Basic” Musical Waveforms:

⇒ Spatial (or temporal) shape of periodic waveform specifies what harmonics are present

e.g. Pluck a guitar string near bridge (over neck) ⇒ brighter (mellower) sound, respectively

[1] Sine Wave: mellow sound (no harmonics)

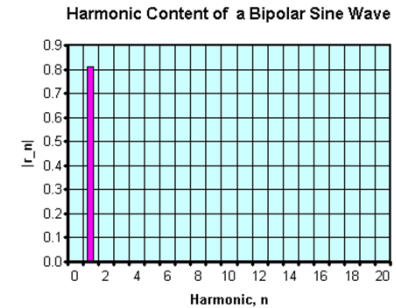
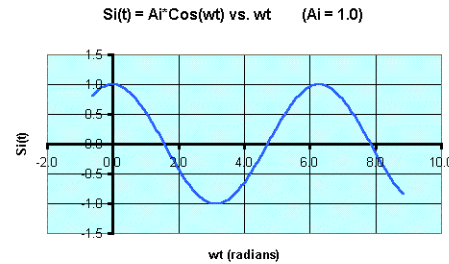

[2] Symmetrical Triangle Wave: A bit brighter sounding (low-order ODD harmonics)

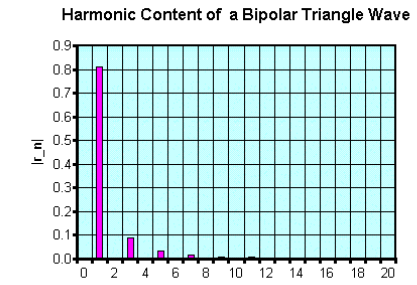
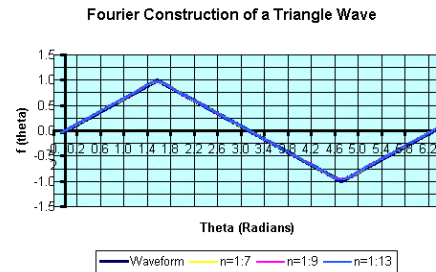

[3] Asymmetrical Triangle Wave: Brighter sounding (has EVEN & ODD harmonics)

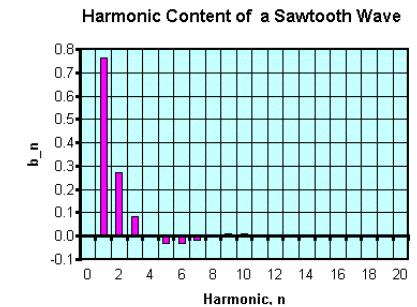
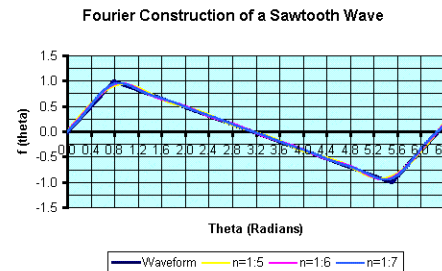

[4] Symmetrical Square Wave: Brighter sounding (has ODD harmonics)

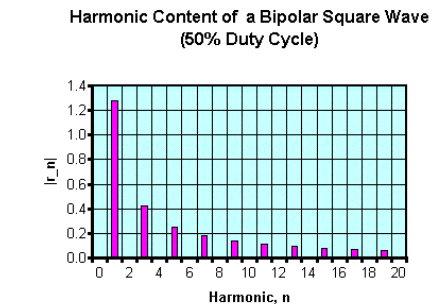
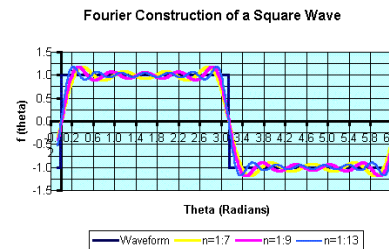

Early Waveform Synthesizers:



Greek Hydraulis
(water organ):
Ctesibius of
Alexandria, 3rd
century BCE



Pipe Organs:
2nd century ACE –
present

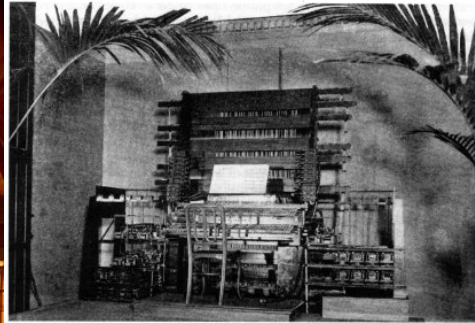

Telharmonium
Mk-I,II & III, NYC:
Thaddeus Cahill
1897-1916

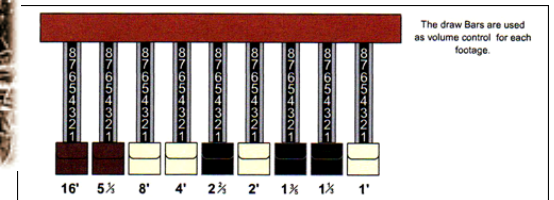

Hammond Organ:
1934 - present

Some Experimental Results from UIUC Physics of Music/Musical Instruments Course(s):

Analyze the harmonic content (amplitude, frequency and phase info vs. time) of quasi-steady complex sounds produced by musical instruments, human voice, etc. using 24-bit digital audio recorder + reference omni-directional condenser mic \Rightarrow .wav file e.g. Tibetan Bowl:

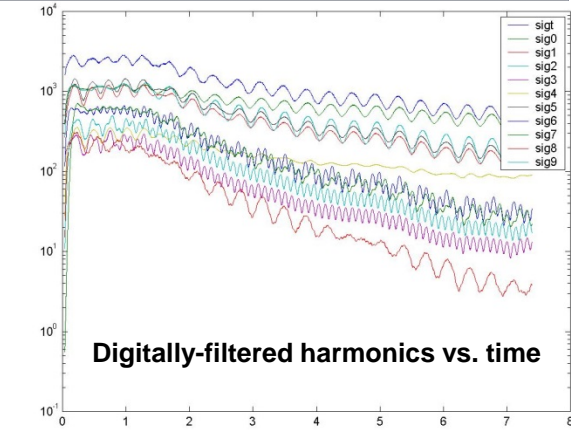
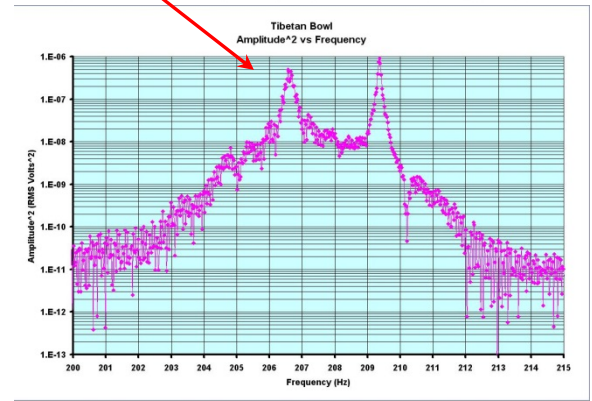
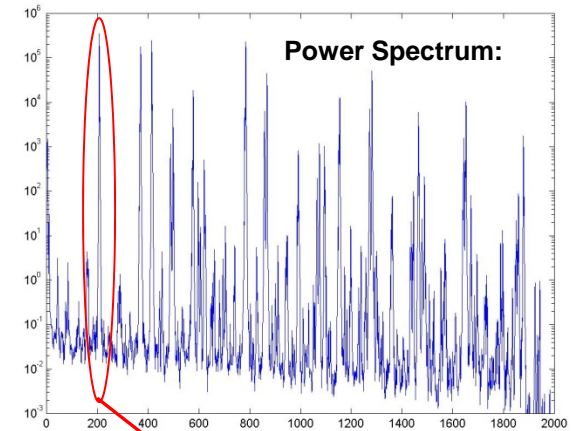
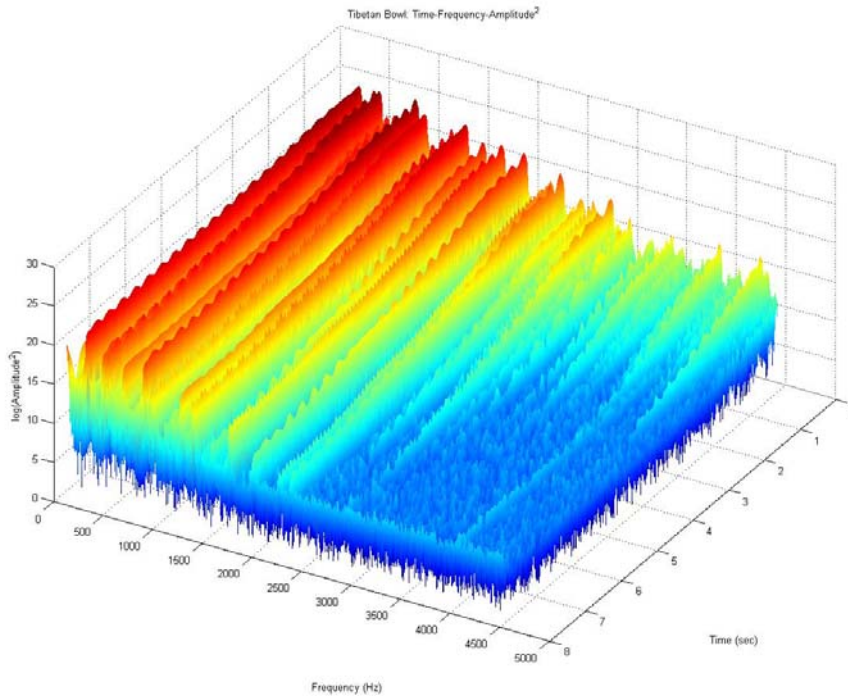

Measurement of Complex Harmonic/Periodic Sound Fields

Complex sound field at point in space *uniquely* determined if simultaneously measure pressure p and particle velocity \vec{u} (= <velocity> of air molecules, spatially averaged over an infinitesimal volume element d^3V).

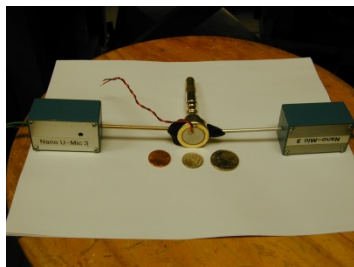
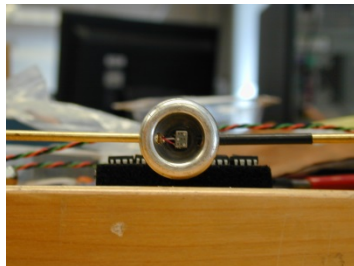
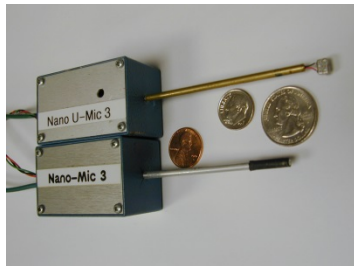

July 31, 2013

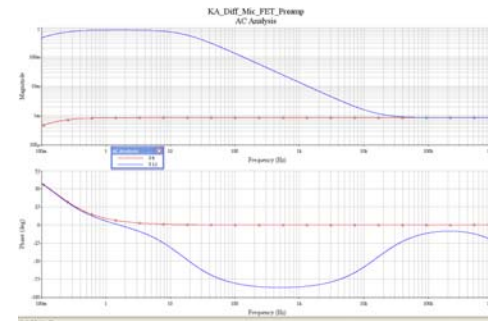
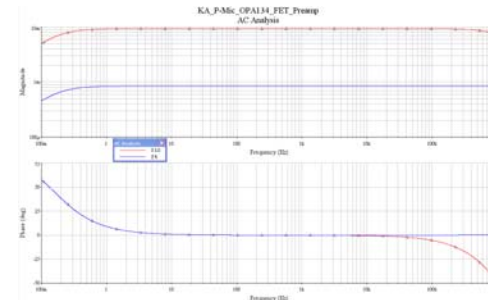
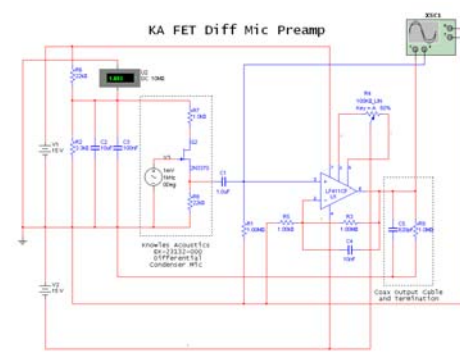
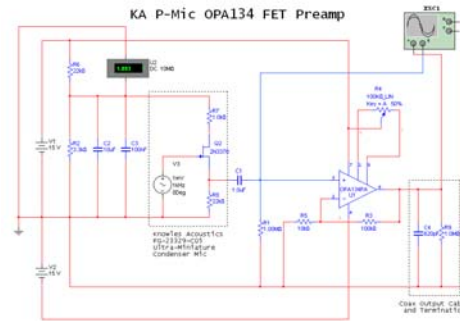

1-D Euler Eqn for *inviscid* fluid flow:

$$\frac{\partial \tilde{u}_z(z,t)}{\partial t} = -\frac{1}{\rho_o} \frac{\partial \tilde{p}(z,t)}{\partial z} \quad \rho_o = 1.204 \text{ kg/m}^3 \text{ for air @ NTP}$$

Integrate:

$$\tilde{u}_z(z,t) = -\frac{1}{\rho_o} \int_{-\infty}^t \frac{\partial \tilde{p}(z,t')}{\partial z} dt' \approx -\frac{1}{\rho_o \Delta z} \underbrace{\int_{-\infty}^t \Delta \tilde{p}(z,t') dt'}_{\text{op-amp integrator}}$$

Sensitivity & Calibration of Mics

Omni-directional Condenser P-mic

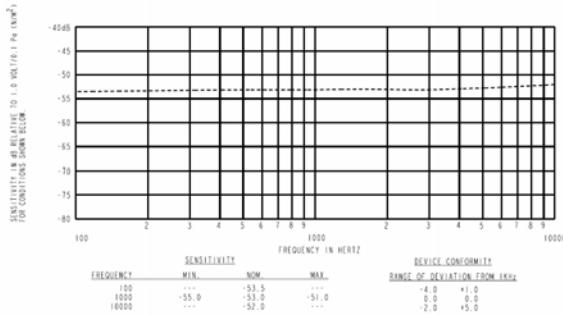

Differential P-mic

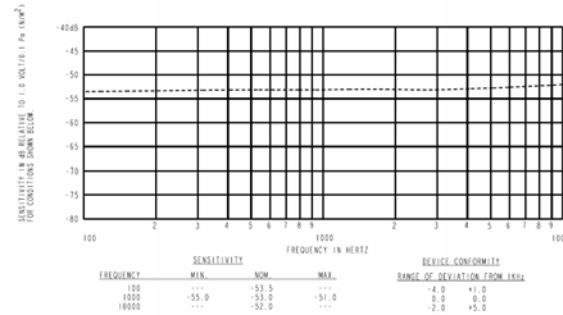

Calibrate Mics e.g. in $SPL = 94.0 \text{ dB}$ sound field:

$$SPL = 94.0 \text{ dB} = 20 \log_{10} \left(\frac{p}{p_{ref}} \right) = 20 \log_{10} \left(\frac{u_z}{u_{ref}} \right)$$

$$\Rightarrow p = 1.0 \text{ RMS Pascals}, \quad u_z = 2.42 \text{ RMS mm/sec}$$

Typical Mic Sensitivities:

$$S_{p-mic} \sim 280 \text{ RMS mV/RMS Pa}$$

$$S_{u-mic} \sim 90 \text{ RMS mV/RMS Pa}^*, \quad 1.0 \text{ RMS Pa}^* = 2.42 \text{ RMS mm/sec}$$

Extech SPL Calibrator



Block Diagram of PC-Based DAQ System

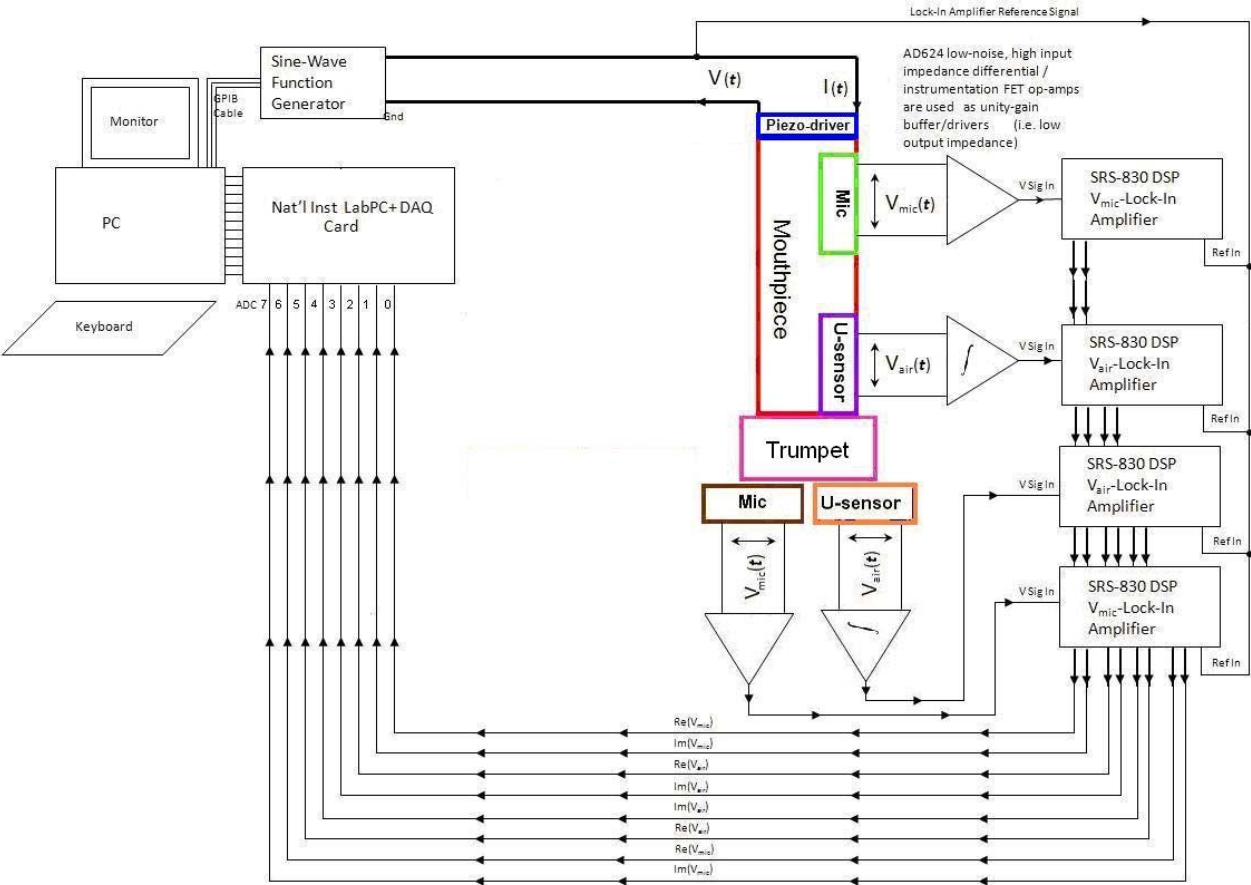

Lock-in Amplifiers (LIA's) measure the in-phase (=“Real”) and 90° out-of phase {aka “quadrature”} (=“Imaginary”) amplitude components (w.r.t. reference sine-wave function generator signal, e.g.

$$p(t) = p_o \cos(\omega t + \phi)$$

$$= p_o \cos \omega t \cos \phi$$

$$- p_o \sin \omega t \sin \phi$$

$$Re \{p\} = p_o \cos \phi$$

$$Im \{p\} = p_o \sin \phi$$

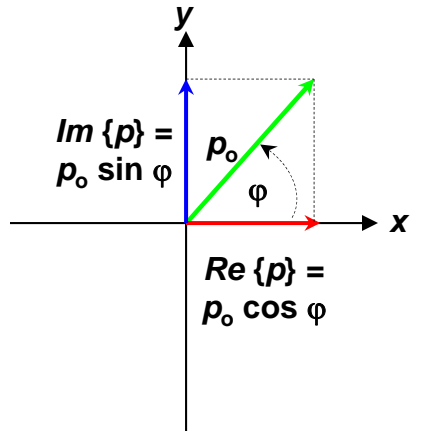

Time Domain (*instantaneous* pressure/particle velocity):

Use e.g. Digital Oscilloscope/Digital Recorder to Measure:

$$\left. \begin{aligned} p(\vec{r}, t) &= p_o(\omega) \cos[\omega t + \varphi_p(\omega)] \\ u_z(\vec{r}, t) &= u_{o_z}(\omega) \cos[\omega t + \varphi_{u_z}(\omega)] \end{aligned} \right\} \begin{array}{l} \text{n.b. phase-referenced w.r.t.} \\ \text{sine-wave fcn generator} \end{array}$$

Complexify:

$$\tilde{p}(\vec{r}, t) = p_o(\omega) e^{i(\omega t + \varphi_p(\omega))} = FT \{ \tilde{p}(\vec{r}, \omega) \}$$

$$\tilde{u}_z(\vec{r}, t) = u_{o_z}(\omega) e^{i(\omega t + \varphi_{u_z}(\omega))} = FT \{ \tilde{u}_z(\vec{r}, t) \}$$

Compute:

$$\xi_z(\vec{r}, t) = \int \tilde{u}_z(\vec{r}, t) dt = \frac{1}{i\omega} \tilde{u}_z(\vec{r}, t)$$

$$a_z(\vec{r}, t) = \frac{\partial \tilde{u}_z(\vec{r}, t)}{\partial t} = i\omega \tilde{u}_z(\vec{r}, t)$$

$$\tilde{Z}_z(\vec{r}, t) = \tilde{p}(\vec{r}, t) / \tilde{u}_z(\vec{r}, t) = I.I.R.(\vec{r}, t)$$

$$\begin{aligned} \tilde{I}_z(\vec{r}, t) &= \frac{1}{2} \tilde{p}(\vec{r}, t) \cdot \tilde{u}_z(\vec{r}, t) \\ &= \frac{1}{2} p_o(\omega) \cdot u_{o_z}(\omega) e^{i[\varphi_p(\omega) - \varphi_{u_z}(\omega)]} \left[1 + e^{-2i[\omega t + \varphi_p(\omega)]} \right] \\ &= \frac{1}{2} I_{o_z}(\omega) e^{i\varphi_{I_z}(\omega)} \left[1 + e^{-2i[\omega t + \varphi_p(\omega)]} \right] \end{aligned}$$

$$w(\vec{r}, t) = \frac{1}{4\rho_o c^2} |\tilde{p}(\vec{r}, t)|^2 + \frac{1}{4} \rho_o |\tilde{u}_z(\vec{r}, t)|^2$$

Frequency Domain:

Use e.g. LIA (and/or Spectral Analysis Techniques) to Measure:

$$\tilde{p}(\vec{r}, \omega) = p_o(\omega) e^{i(\omega t + \varphi_p(\omega))} = FT \{ \tilde{p}(\vec{r}, t) \} \quad \{Pascals\}$$

$$\tilde{u}_z(\vec{r}, \omega) = u_{o_z}(\omega) e^{i(\omega t + \varphi_{u_z}(\omega))} = FT \{ \tilde{u}_z(\vec{r}, t) \} \quad \{mm/sec\}$$

Compute:

$$\xi_z(\vec{r}, \omega) = \int \tilde{u}_z(\vec{r}, \omega) dt = \frac{1}{i\omega} \tilde{u}_z(\vec{r}, \omega) \quad \{mm\}$$

$$a_z(\vec{r}, \omega) = \frac{\partial \tilde{u}_z(\vec{r}, \omega)}{\partial t} = i\omega \tilde{u}_z(\vec{r}, \omega) \quad \{mm/sec^2\}$$

$$\begin{aligned} \tilde{Z}_z(\vec{r}, \omega) &= \tilde{p}(\vec{r}, \omega) / \tilde{u}_z(\vec{r}, \omega) \quad \{Acoustic Ohms(Pa-sec/m)\} \\ &= \frac{1}{2} p_o(\omega) \cdot u_{o_z}(\omega) e^{i[\varphi_p(\omega) - \varphi_{u_z}(\omega)]} = Z_{o_z} e^{i\varphi_{Z_z}(\omega)} \end{aligned}$$

$$\begin{aligned} \tilde{I}_z(\vec{r}, \omega) &= \frac{1}{2} \tilde{p}(\vec{r}, \omega) \cdot \tilde{u}_z^*(\vec{r}, \omega) \quad \{Watts/m^2\} \\ &= \frac{1}{2} p_o(\omega) \cdot u_{o_z}(\omega) e^{i[\varphi_p(\omega) - \varphi_{u_z}(\omega)]} = I_{o_z} e^{i\varphi_{I_z}(\omega)} \end{aligned}$$

$$w(\vec{r}, \omega) = \frac{1}{4\rho_o c^2} |\tilde{p}(\vec{r}, \omega)|^2 + \frac{1}{4} \rho_o |\tilde{u}_z(\vec{r}, \omega)|^2 \quad \{Joules/m^3\}$$

Real part of complex **I**, **Z** associated with propagating sound

Imaginary part of complex **I**, **Z** associated with non-propagating sound energy (e.g. in “near-field” $r \ll \lambda$ of sound source, or e.g. in SWT (where $\mathbf{Re}\{\mathbf{I}, \mathbf{Z}\} \sim 0$))

Acoustic Impedance analogous to Electrical Impedance

Electrical Impedance $\tilde{Z}_e = \frac{\tilde{V}}{\tilde{I}}$

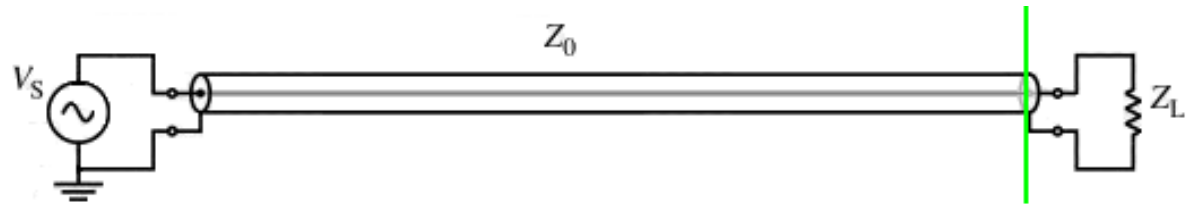

Acoustic Impedance $\tilde{Z}_a = \frac{\tilde{P}}{\tilde{U}}$

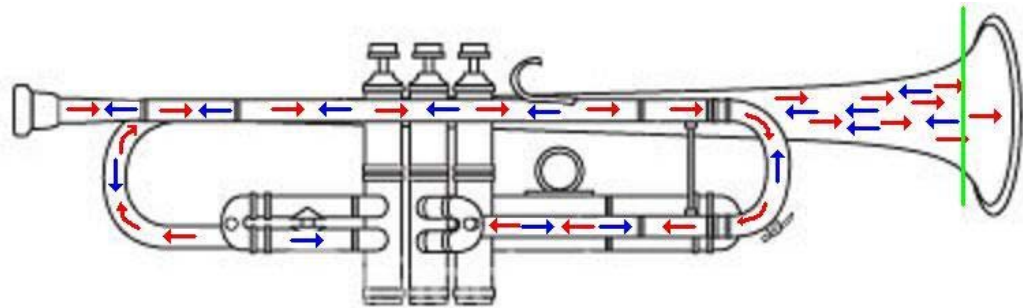

Impedance mismatch @ bell end means wave reflection, constructive interference of standing waves @ mouthpiece reinforces buzzing of player's lips!

$|Z_{in}|$ maxima (pressure maxima, particle velocity minima occur for constructive interference) corresponds to standing waves, i.e. playable notes!

Measure input & output impedances $Z(f) = p(f)/u(f)$ of brass/wind instruments
 \Rightarrow Maxima of $Z_{in}(f)$ defines which notes are playable on the instrument:

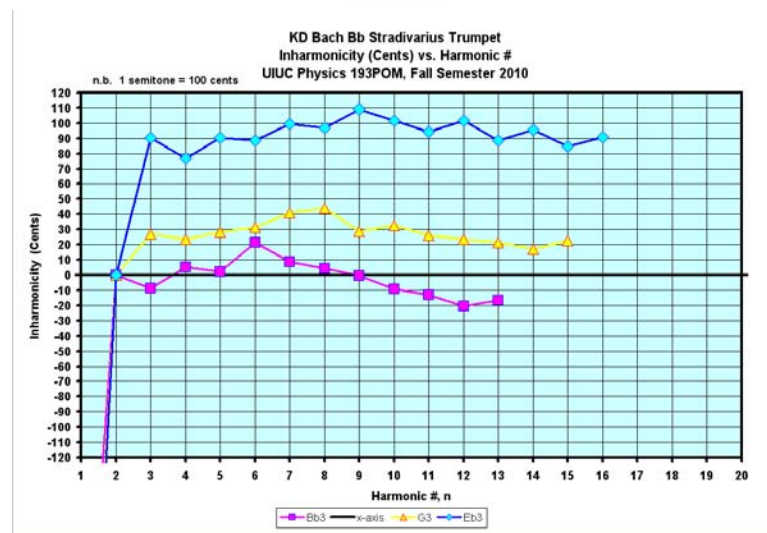
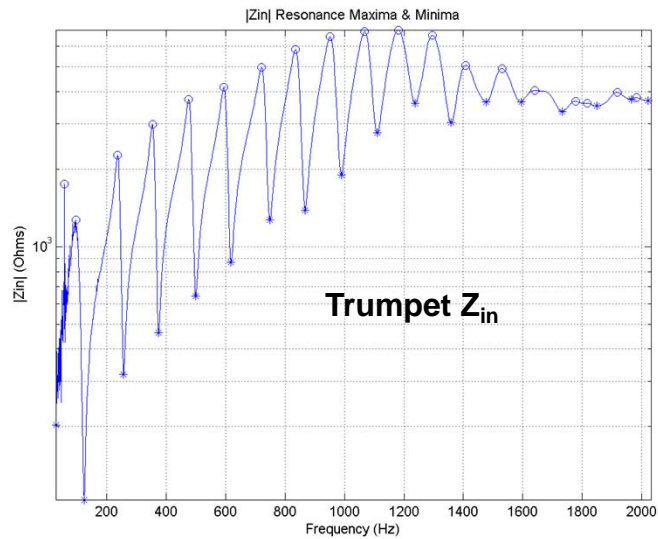
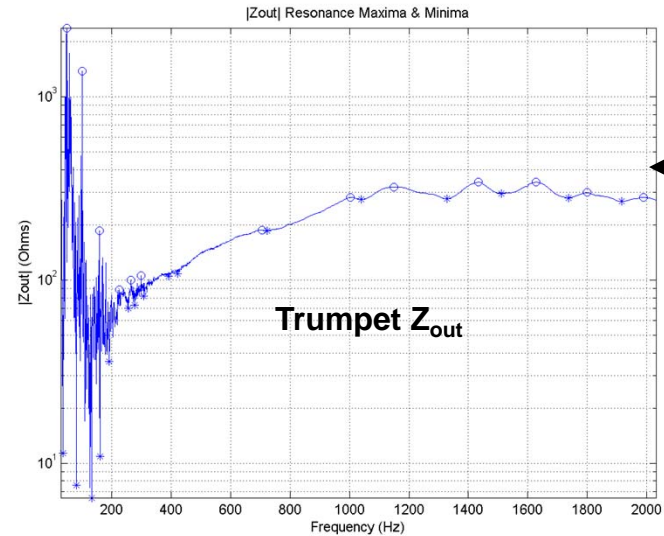

Acoustical Properties of Individual Components of Trumpet

J. Backus, JASA 60, 460-80, 1976

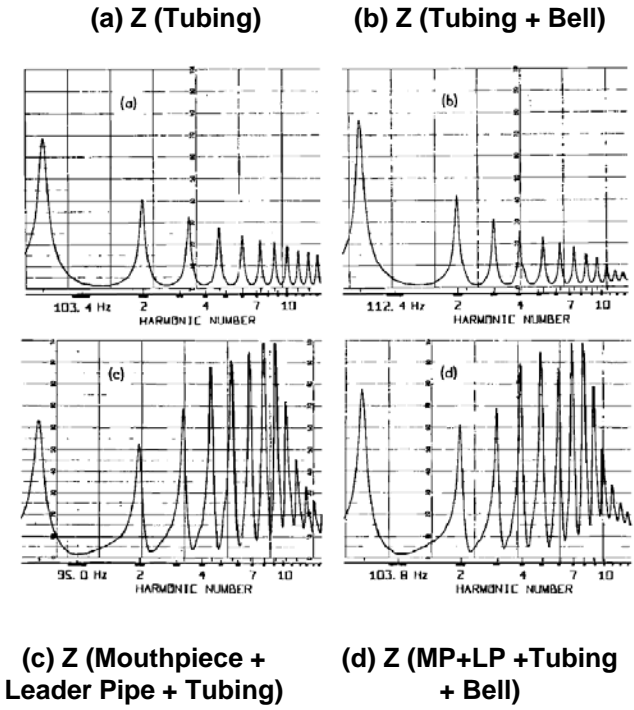

FIG. 2. Input impedance curves for (a) a length of cylindrical tubing; (b) tubing plus trumpet bell; (c) tubing plus mouthpiece and leader pipe; and (d) tubing plus bell plus mouthpiece and leader pipe. Full scale is 1000 Ω .

Trumpet Inharmonicity:

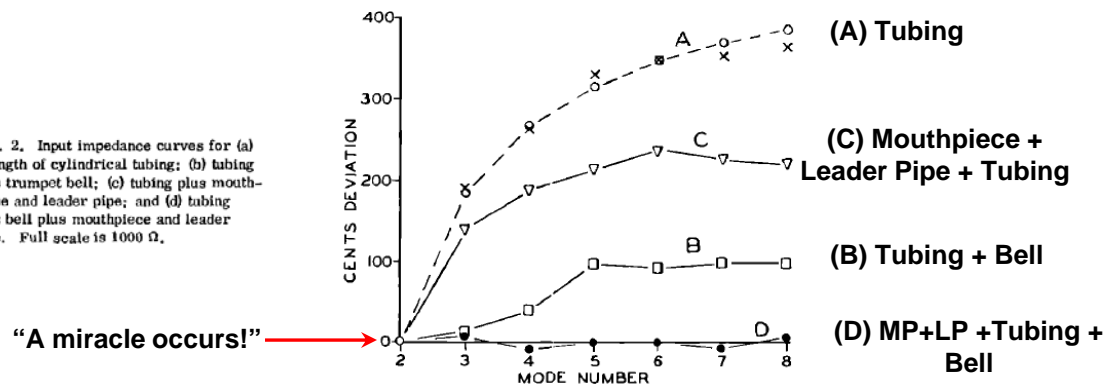
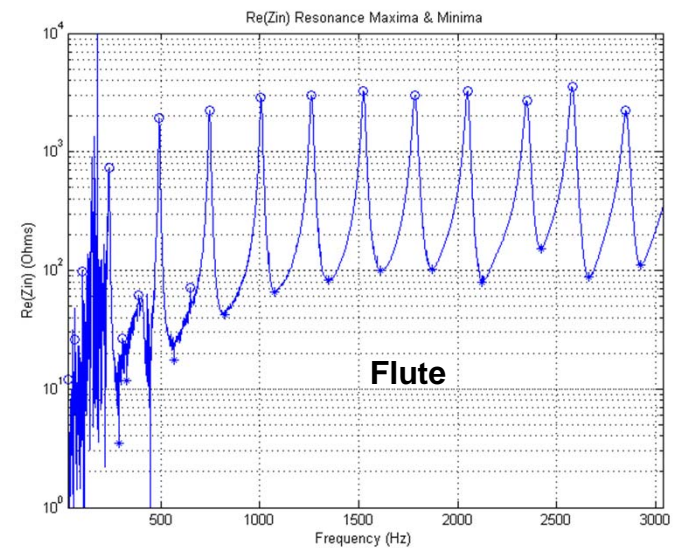
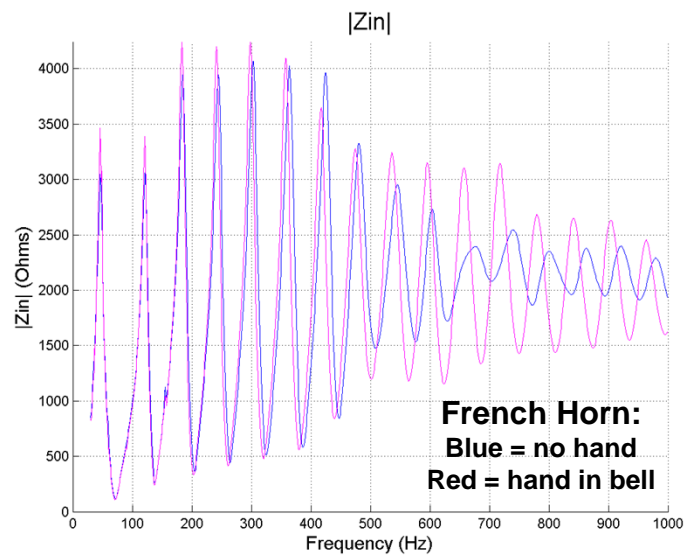

FIG. 3. Plots of the discrepancies in cents between the n th resonance and the n th harmonic, with the second resonance coinciding with the second harmonic. (a) Cylindrical tubing; (b) tubing plus bell; (c) tubing plus leader pipe and mouthpiece; and (d) tubing plus bell plus leader pipe and mouthpiece.

n.b. The design of the trumpet – centuries old instrument {1500 BCE; valves added ~ 1793} {as well as many other musical instruments} didn't have the benefit of the modern scientific knowledge of acoustics that we have today – musical solution(s) arrived at iteratively, by persistent effort(s) !!!

Have Measured Acoustic Properties of {Many Other} Other Brass/Wind Instruments, e.g.



UIUC P406POM Modal Vibes DAQ Experiment: *Phase-Sensitive* Near-Field Acoustic Holography!



p -complex plane

u -complex plane

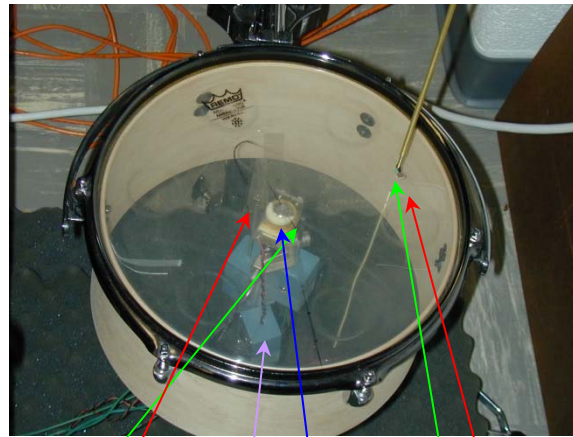

p, u monitor mics

CC NIC + coil driver + rare-earth magnet pair

p, u scan mics

Block Diagram of Modal Vibes DAQ System:

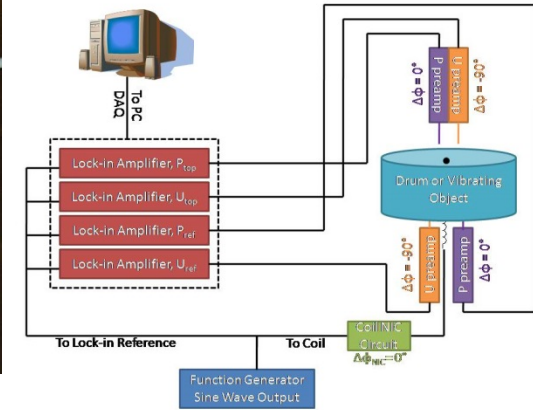

Mode-lock to resonant frequency of drum:

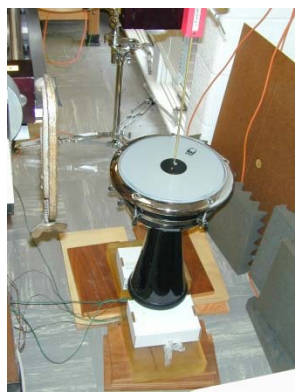
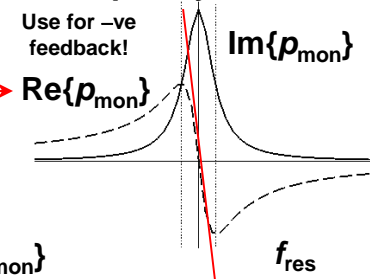

Dombek:

J_{11} Vibrational Mode of Dombek:
(32x32 = 1024 scan points, 1 cm step size)
 $Im\{p(x,y)\}$ $Re\{u(x,y)\}$

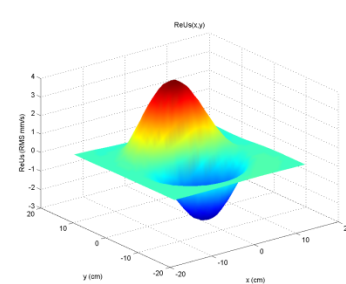
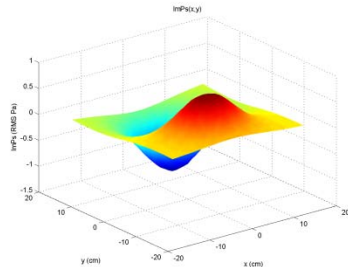

Phase{ p_{mon} }

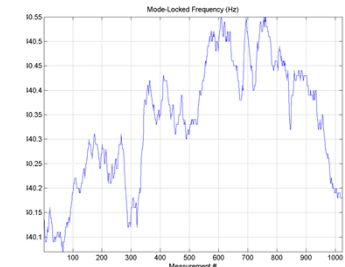
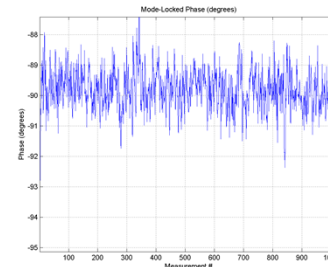

July 31, 2013

UIUC NSF REU POM Talk

Drums very sensitive to ambient temperature changes!

Mechanical Modal Vibrations of Stringed Instruments:

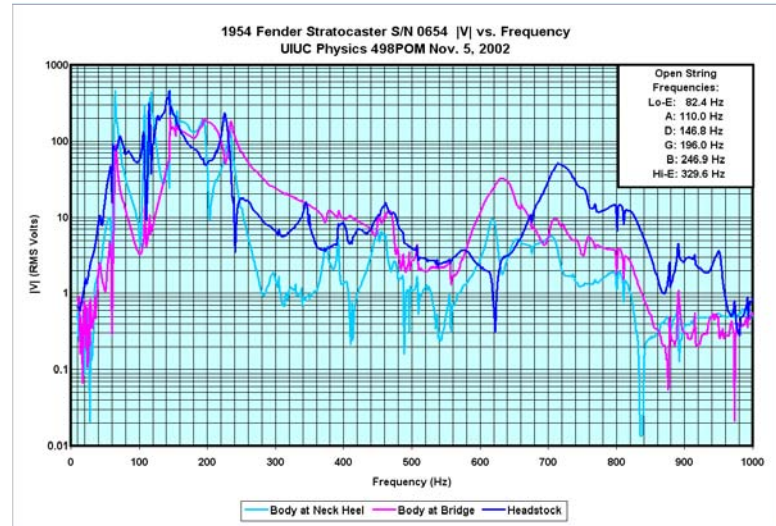
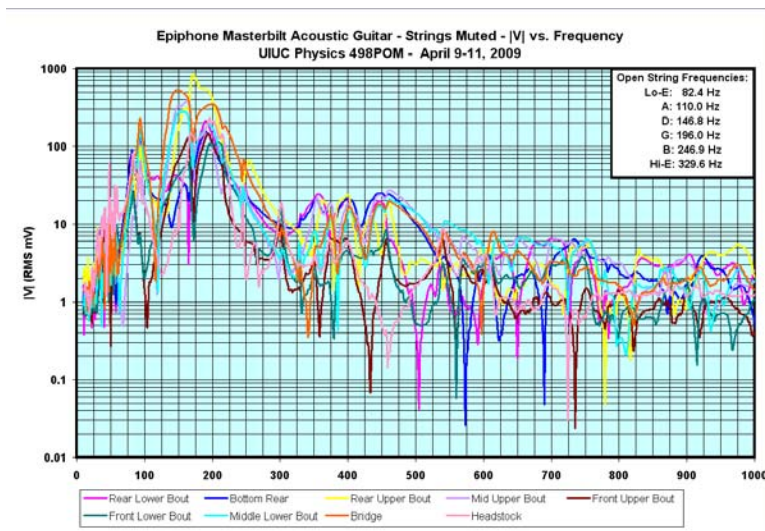
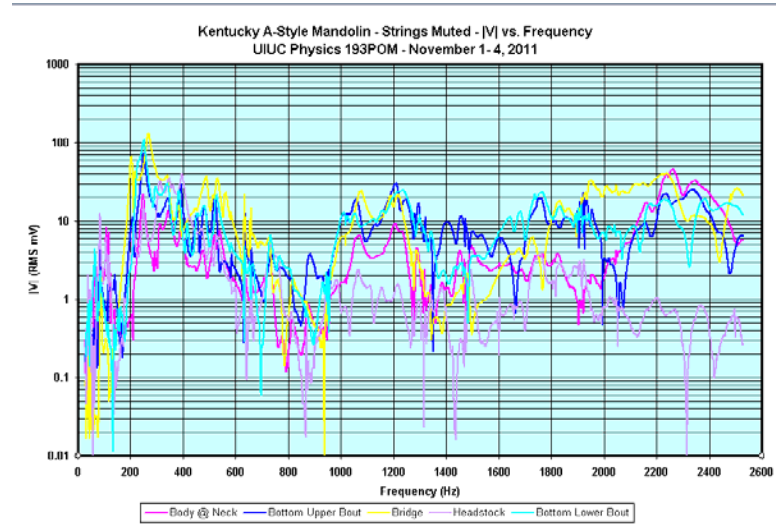

Complex Sound Field of Loudspeakers/Arrays of Loudspeakers:



f = 1 KHz

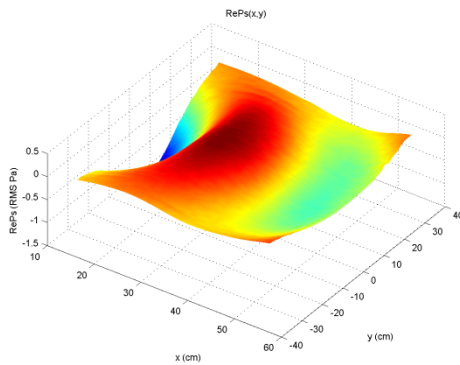

f = 2 KHz

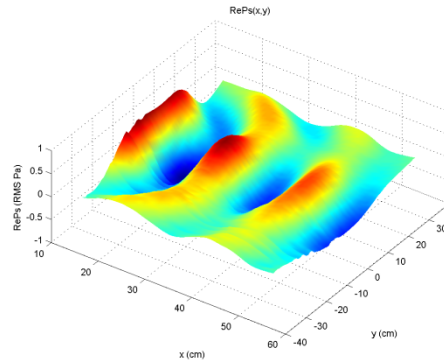

f = 5 KHz

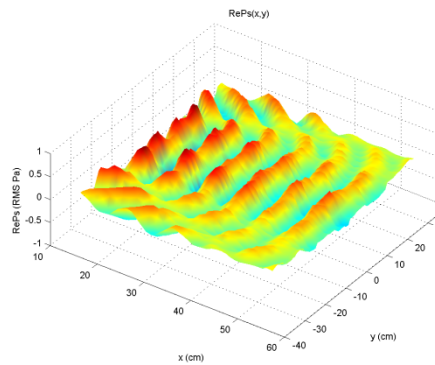

f = 10 KHz

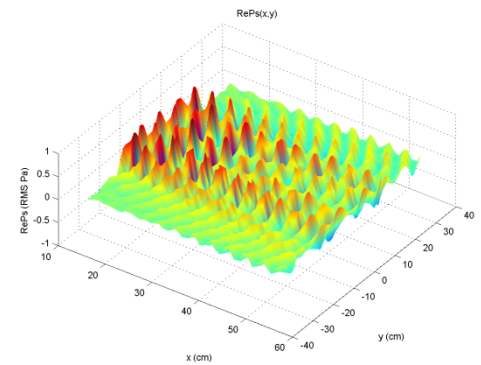

Auditorium/Room Acoustics:

Inject white noise (flat frequency spectrum) into a room, allow it to equilibrate, then adiabatically rapidly shut off sound source and measure exponential decay rate of sound vs. frequency (32 1/3-octave bands):

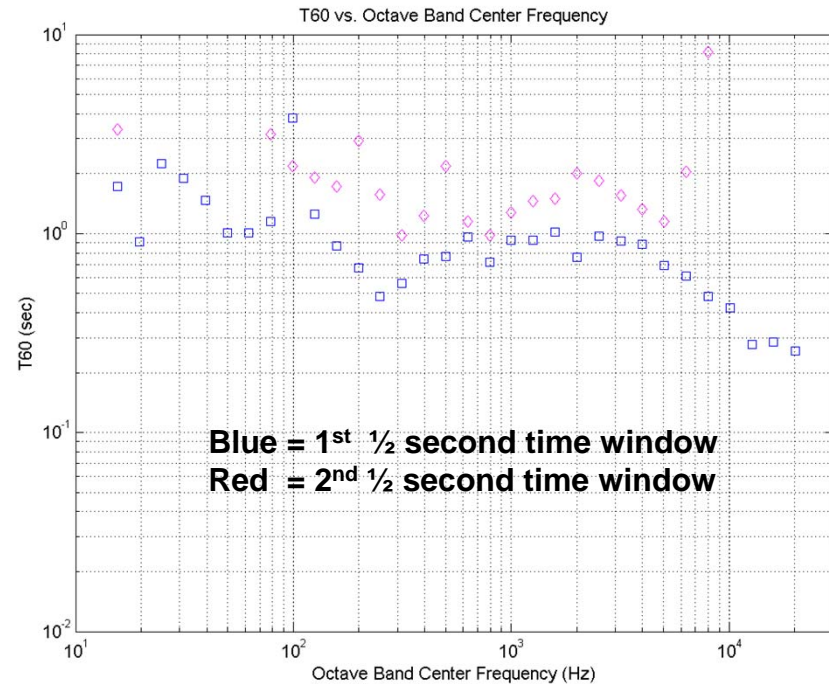
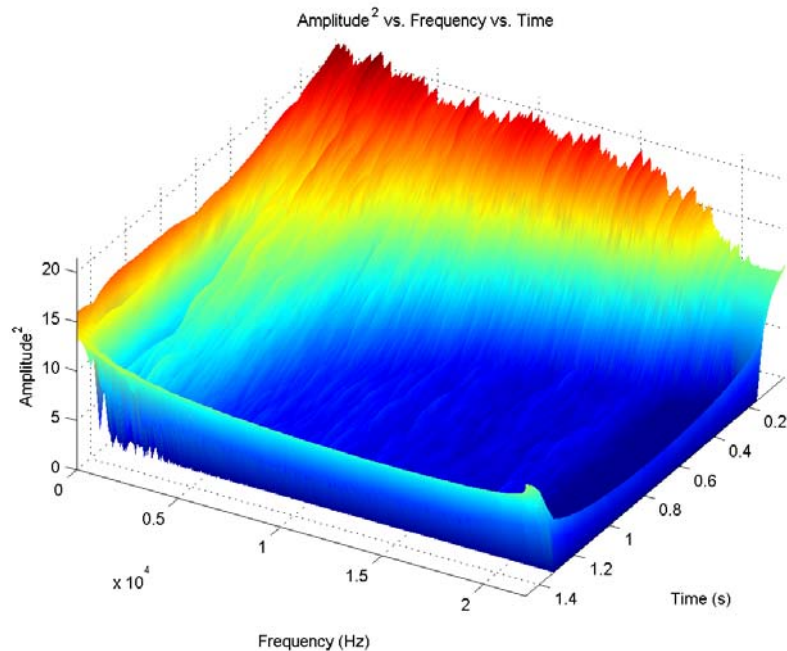

Recording Studio, UIUC School of Music

$$T_{60} \equiv -\frac{1}{2} \ln(10^{-6}) \cdot \tau_p \approx 6.91 \tau_p$$

Time for sound to fall to 1 millionth of initial intensity

$$(\Delta \text{SIL} = -60 \text{ dB} = 10 \log_{10}(I_{\text{final}}/I_{\text{init}}))$$

Marimba Studies:



Sculpting of underside of marimba bar tunes bar, and harmonic content: 1 (fund), 4th, 10th & 20th...

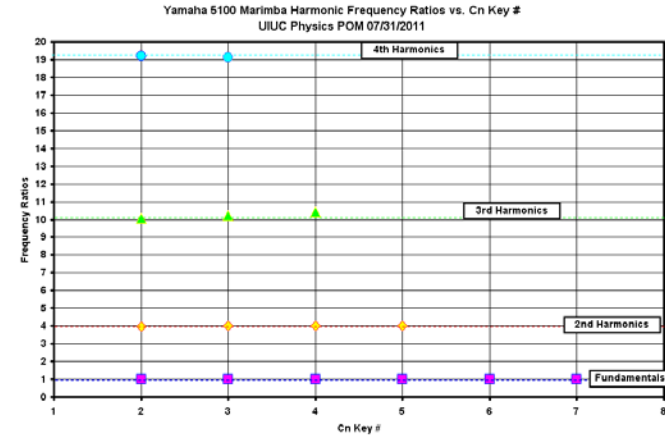

Mallet strike location – varies harmonic content/tone:

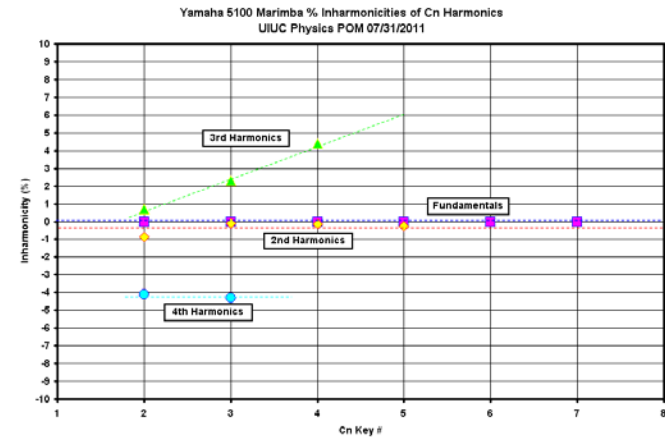
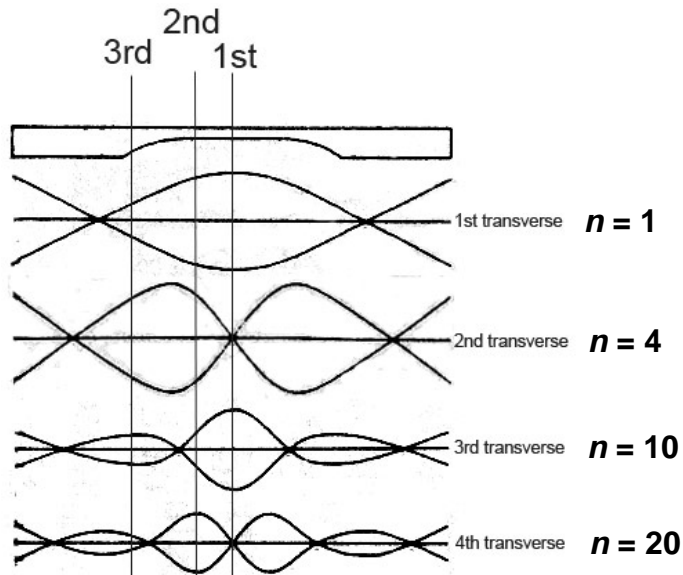

Resonators underneath marimba = open-closed organ pipe, matched to fundamental of each bar.

$$f_n = n f_1, n = 1, 3, 5, 7 \dots \{\text{odd harmonics}\}$$

⇒ Boosts fundamental

Marimba Studies – Measurement of the decay time(s) of harmonics of the C_n marimba bars ($n = 2:7$) and extraction of absorption coefficient η of rosewood

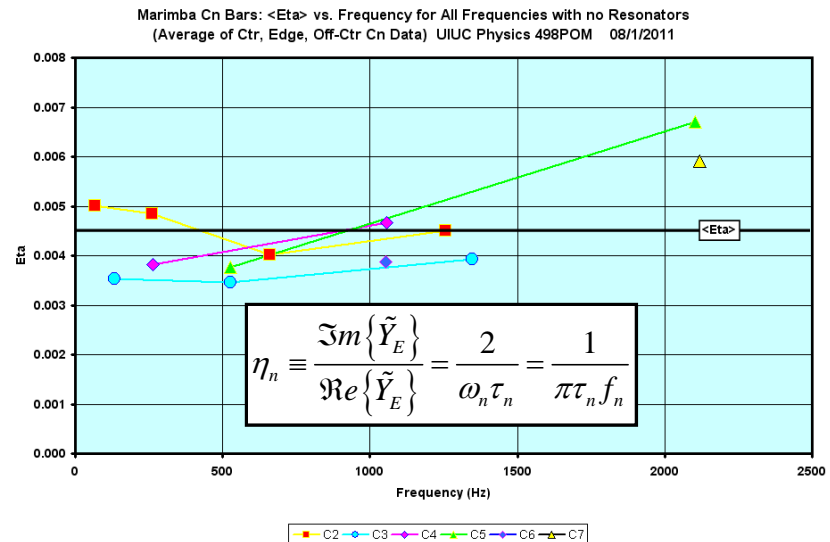
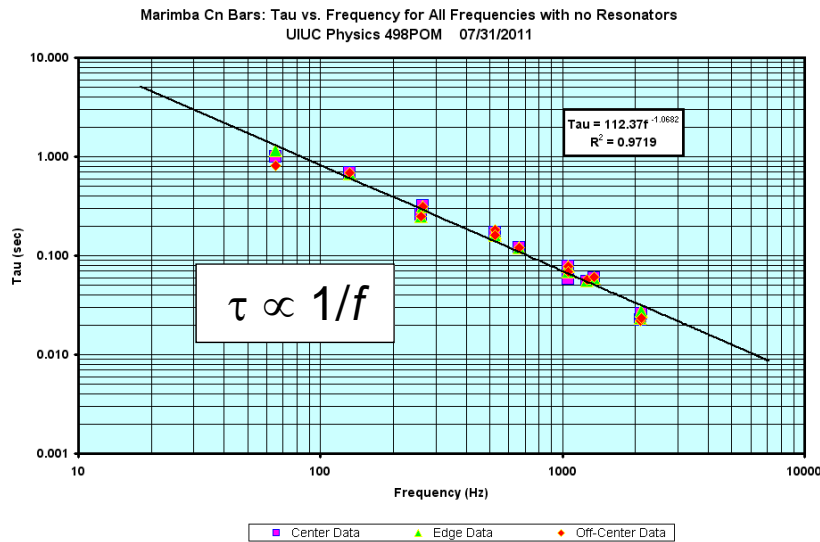
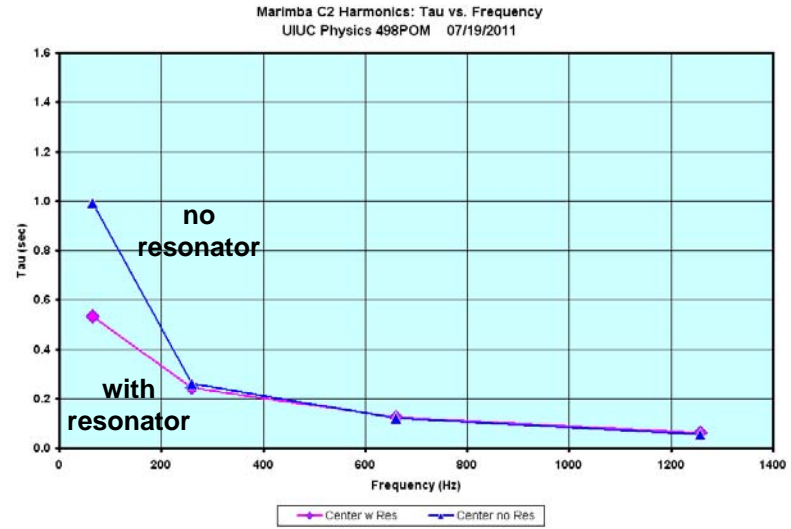
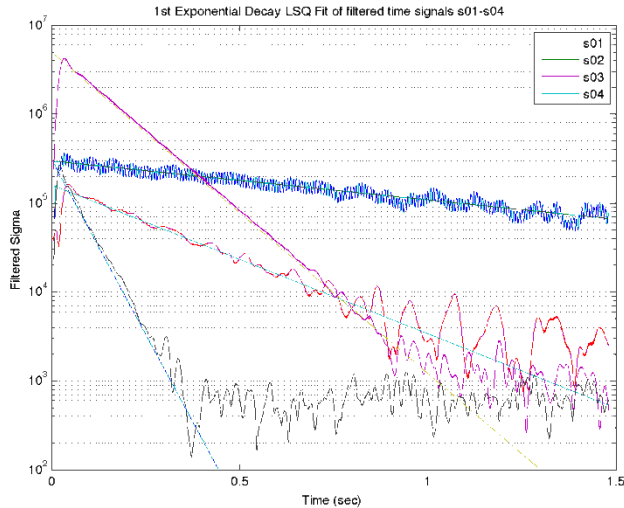

Fun with Spectral Analysis of (Any Kind of/YOUR Favorite) Music: Use e.g. AUDACITY (free-ware)

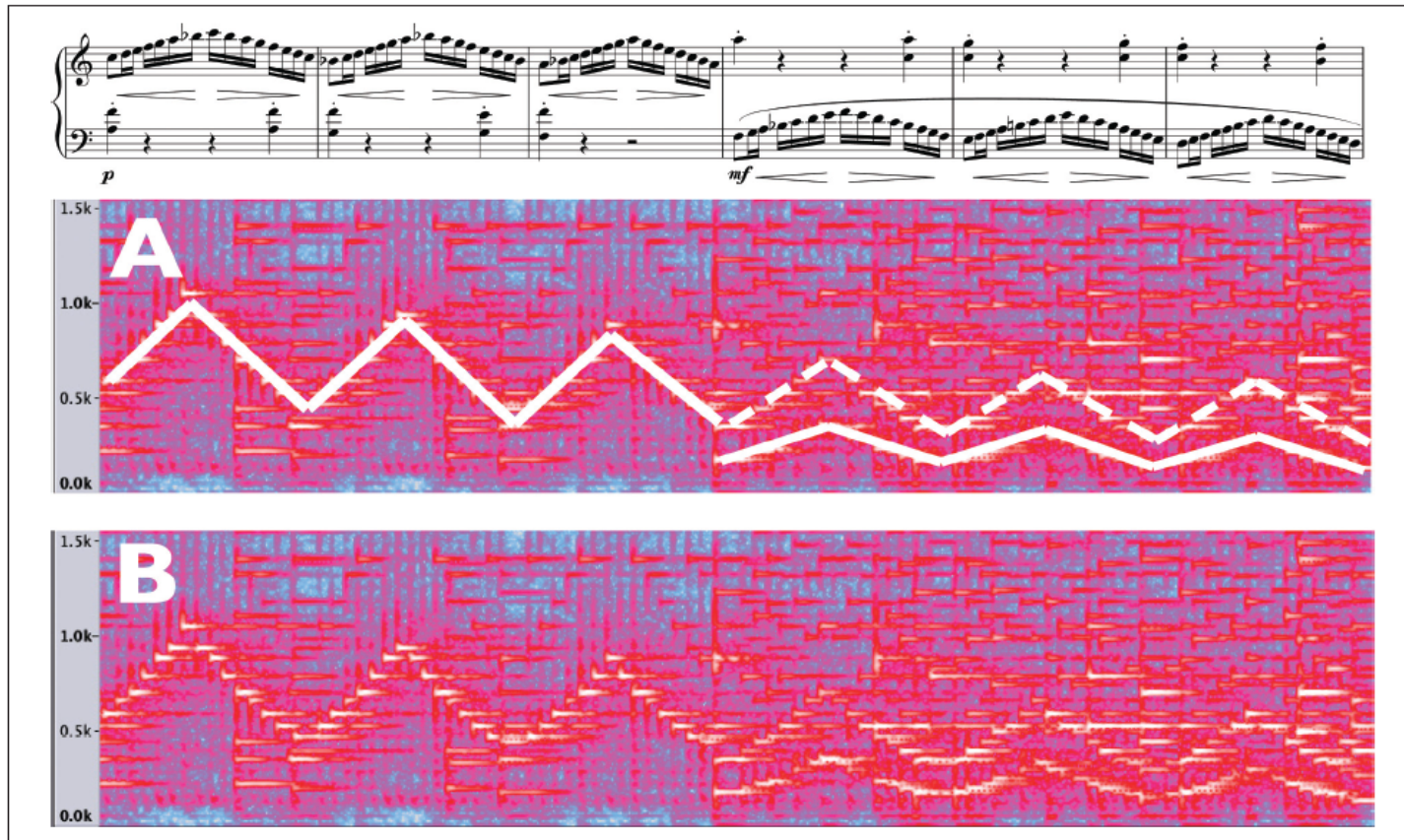

Figure 2. Underneath a standard score view, a spectrogram presents the false transition from Mozart K545. Image (A) is marked to help notice the octaves in unmarked image (B), which presents one reason listeners comfortably adapt to octave jumps. The top image (A) marks the fundamental pitch with a solid white line, which jumps down one octave halfway through the passage. When the line jumps, the dashed line makes clear that the overtone at the octave continues the original line

See e.g. Matthew D. Thibeault paper at: <http://gmt.sagepub.com/content/25/1/50>