

**PHYS 575,
Particle Physics I
Spring 2022**

What is a particle?

Theory:

irreducible representation of the Poincaré group
labeled by mass, spin, charge
(more on this in next 3 weeks!)

$$P^\mu P_\mu = m^2, \quad W^\mu W_\mu = -m^2 s(s+1), \quad \delta\phi = iQ\alpha\phi$$

**This course:
use these theory tools...**

Experiment:

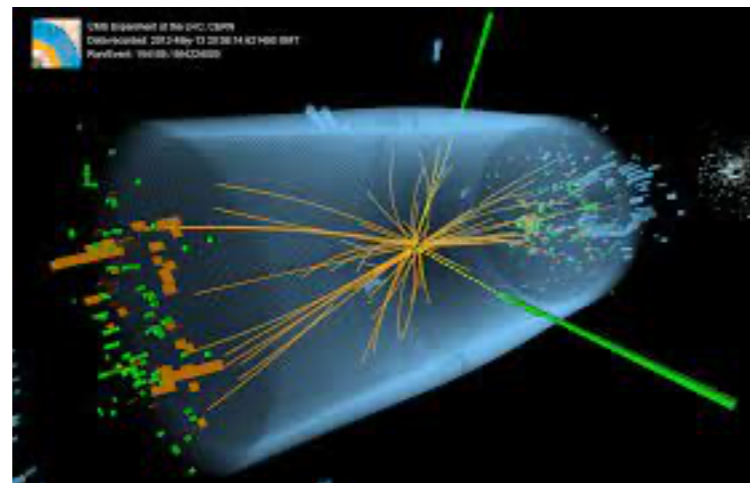
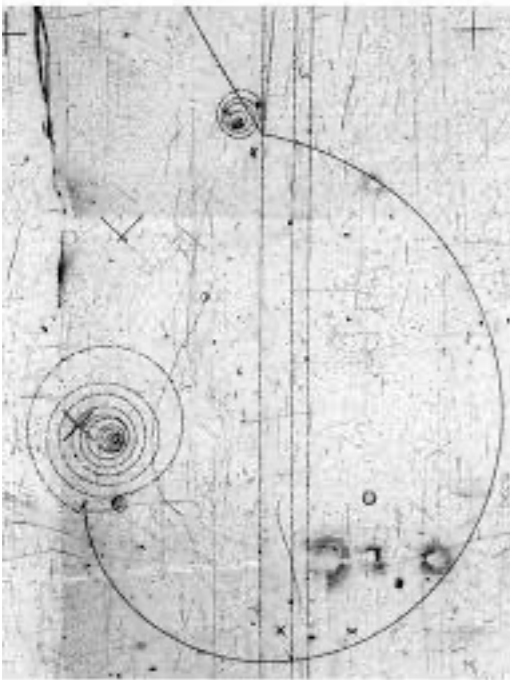

**...to understand
experimental results
like these**

The Standard Model

A theory which explains the results of every experiment ever done on Earth, to up to 12 decimal places, with exceptions you can count on one hand.

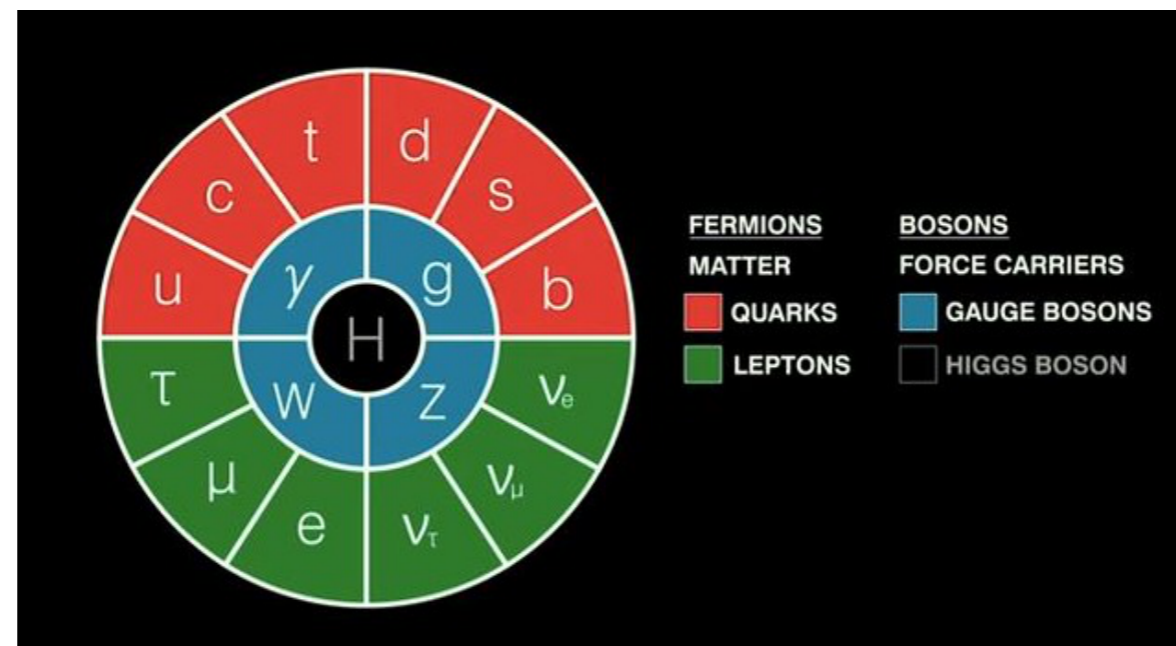

These are just the elementary particles:
they can combine in myriad ways to give composite particles.

Historically, we mostly saw the composite particles first, which led to some rather confusing naming conventions, so let's take a brief tour through history... (mostly borrowed from Ch. 1 of Griffiths, "Introduction to Elementary Particles")

Particle physics in 1932

1897: J.J. Thomson discovers **electron**
in cathode ray tubes

1908-1913: Rutherford gold foil experiments
show nucleus is positively charged -> **proton**

1905 - 1923: Photoelectric effect + Compton
scattering show light is a particle -> **photon**

1932: Chadwick discovers the **neutron**

What is stuff made of?

$$p, n, e^{-}, \gamma$$

Atoms have a nucleus of
protons + neutrons,
with orbiting electrons,
which emit photons
when excited

Not for long...

Pions and muons

What causes the nucleus to stay together? Need a short-range force (“strong force”) that overcomes the electrostatic repulsion between protons

Yukawa 1932: a particle of mass ~ 150 MeV could mediate the strong force.

This is midway between electron mass (511 keV) and proton mass (939 MeV), so called it a “**meson**” (middle-weight). Similarly, electron is a “**lepton**” (light-weight) and protons and neutrons are “**baryons**” (heavy-weight)

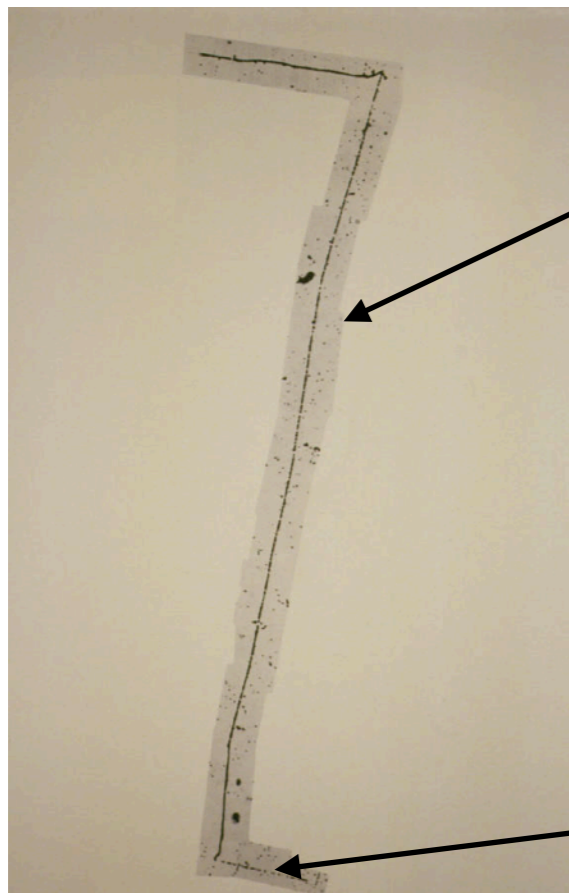

...but wait, there are **two** particles! (1947)

$$\pi \rightarrow \mu + \dots \quad (\text{short-lived, mediates strong force})$$

$$\mu \rightarrow e + \dots \quad (\text{long-lived, “who ordered that?”})$$

Pi meson (or pion) and mu lepton (muon) just happen to be close in mass, this was a confusing coincidence...

Cosmic ray experiments: aha! A new particle! (1937)

Antiparticles

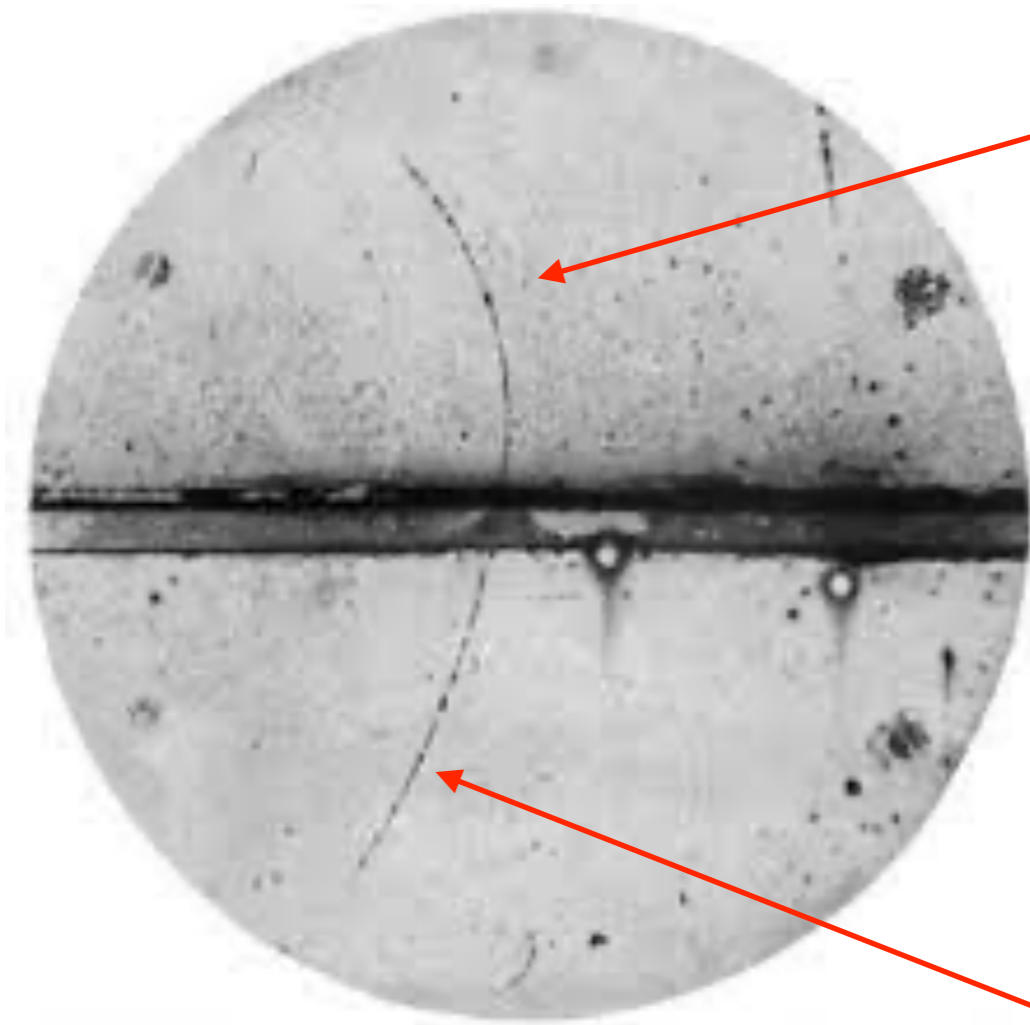

“after” = above the plate, particle was traveling upwards, must be positively charged!

lead plate: particles lose energy, radius of curvature decreases

$$\mathbf{F} = q\mathbf{v} \times \mathbf{B}$$

curved track = positively charged particle going upwards, or negatively charged particle going downwards

This was the first discovery of the positron (anti-electron), predicted by Dirac one year earlier

Neutrinos

Beta decay: if $n \rightarrow p + e^-$ were a two-body process, energy of the outgoing electron would be fixed. But it isn't!

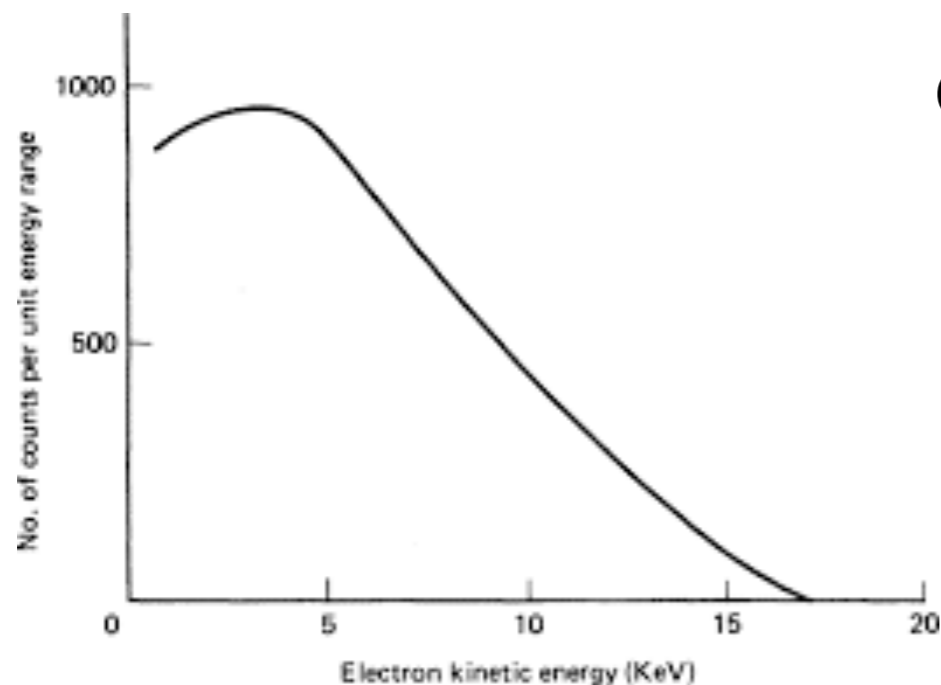

Option 1: give up on energy-momentum conservation

Option 2 (Pauli, 1930): some invisible neutral particle is also emitted in beta decays

“Dear radioactive ladies and gentlemen...”

Conveniently, this also explains the “kinks” in the pion and muon decay tracks:

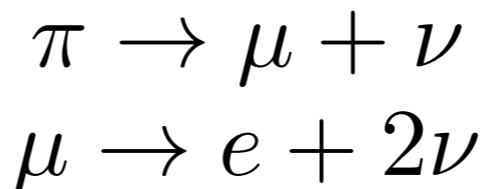

Fast-forward 50 years: there is a neutrino associated to each lepton. $\nu_e, \nu_\mu \dots$

Too many particles...

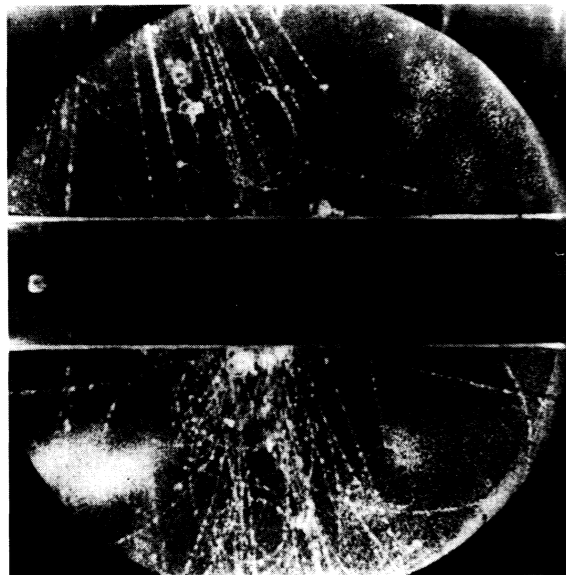

K^0
("neutral kaon")

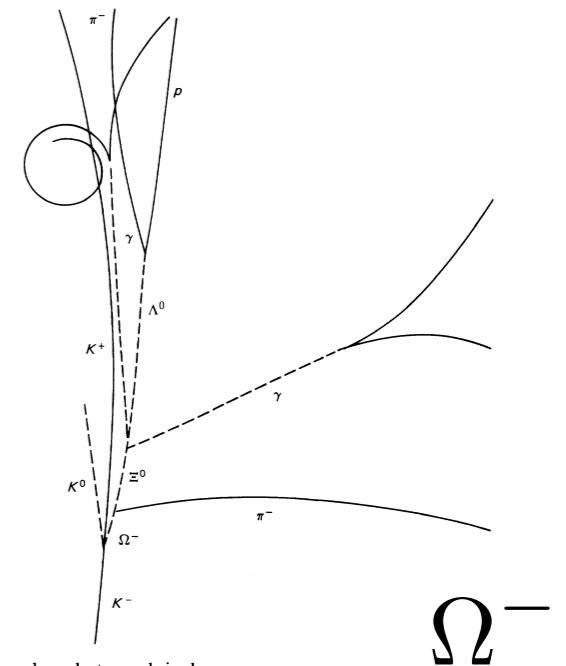
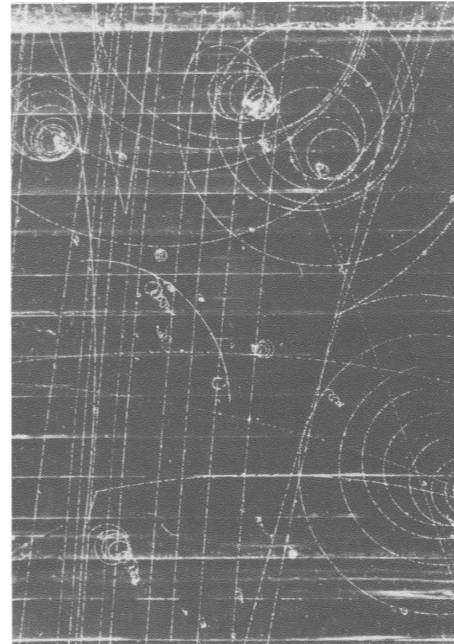
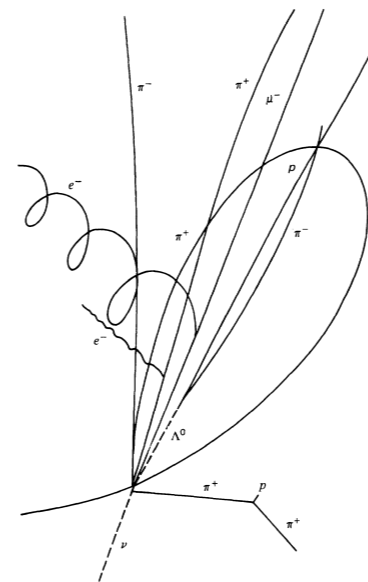
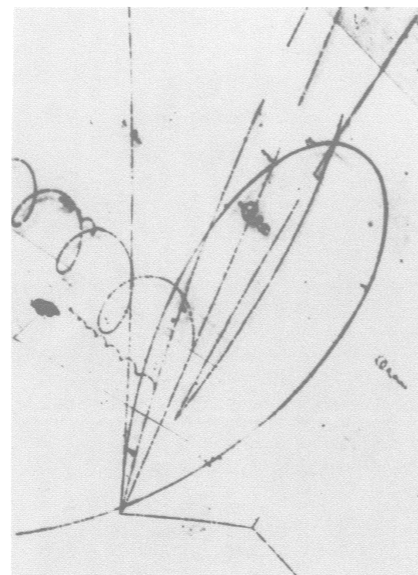
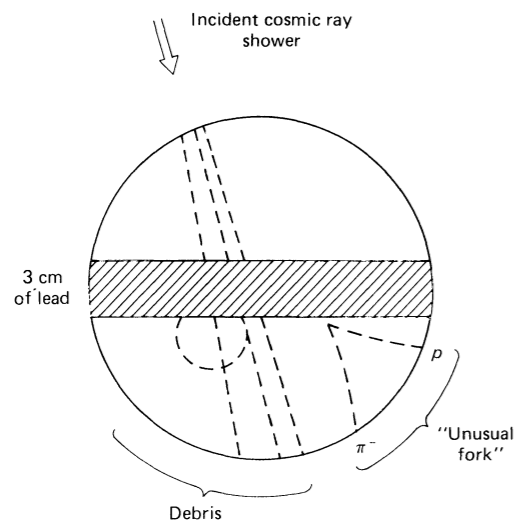

Figure 1.10 The discovery of the Ω^- . The actual bubble chamber photograph is shown on the left; a line diagram of the relevant tracks on the right. (Photo courtesy Brookhaven National Laboratory.)

Ω^-



Λ_c^+

Figure 1.14 The charmed baryon. The probable interpretation of this event is $\nu_\mu + p \rightarrow \Lambda_c^+ + \mu^- + \pi^+ + \pi^-$. The charmed baryon decays ($\Lambda_c^+ \rightarrow \Lambda + \pi^+$) too soon to leave a track, but the subsequent decay of the Λ is clearly visible. (Photo courtesy of N. P. Samios, Brookhaven National Laboratory.)

Quarks and gluons

Maybe all of these particles aren't fundamental at all, but rather bound states of some more fundamental constituent. Gell-Mann and Ne'eman: **quarks**

u, d, c, s, t, b

“up, down, charm, strange, top, bottom”

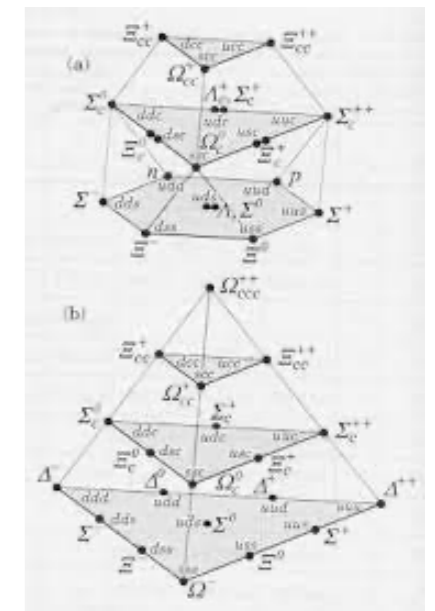
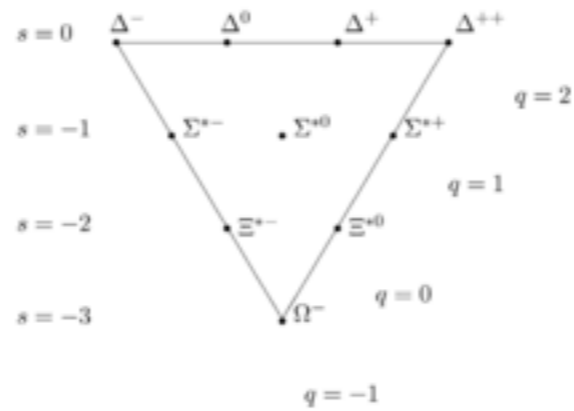
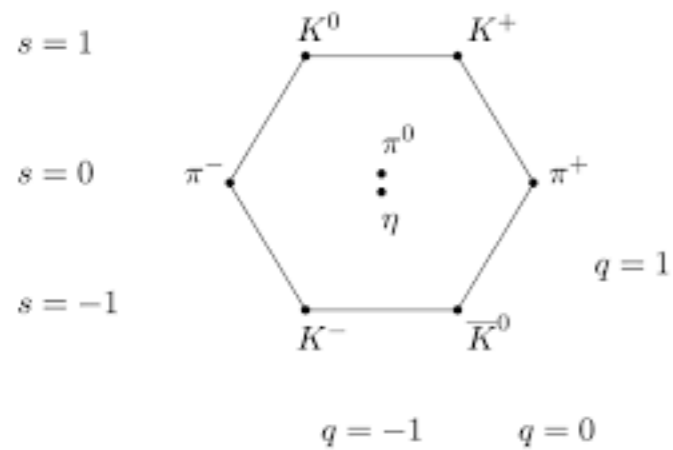

$$\pi^+ = u\bar{d}, p = uud, K^+ = u\bar{s}, \dots$$

Why these weird patterns? Group theory. (Take PHYS 570!)

Heavier quarks decay faster, are harder to see: need high-energy accelerators

If pions don't mediate the strong force anymore, what does? Gluons (= “glue”)

Three generations

The heavier quarks and leptons seem to have most of the same properties (charge, interactions) as electron and up/down quarks.

Kind of like the periodic table, can we predict new particles this way?

Tau lepton: predicted in 1960-1970,
discovered in 1974-1977, Nobel prize 1995

Bottom quark: predicted in 1973,
discovered in 1977, Nobel prize 2008

Top quark: predicted in 1973,
discovered in 1995 (no Nobel prize)

At this point, strong experimental
evidence that this is it:
there are 3 “generations” (copies)
of each lepton/neutrino
and quark pair

W and Z bosons

Photons mediate the electromagnetic force. Gluons mediate the strong force.

What mediates the “weak force” responsible for beta decay?

Fermi 1933: nothing, this is an infinitely short-ranged interaction

But as we will see in this course, QM would then predict probabilities > 1 !

Glashow, Weinberg, Salam, 1964-1967: electromagnetism and weak force **unify** at high energies, like electricity + magnetism

Predicts two new spin-1 particles, W (charged) and Z (neutral), which mediate the electroweak force, as well as their masses

Discovered at CERN by Rubbia et al in 1983! Nobel prizes all around.

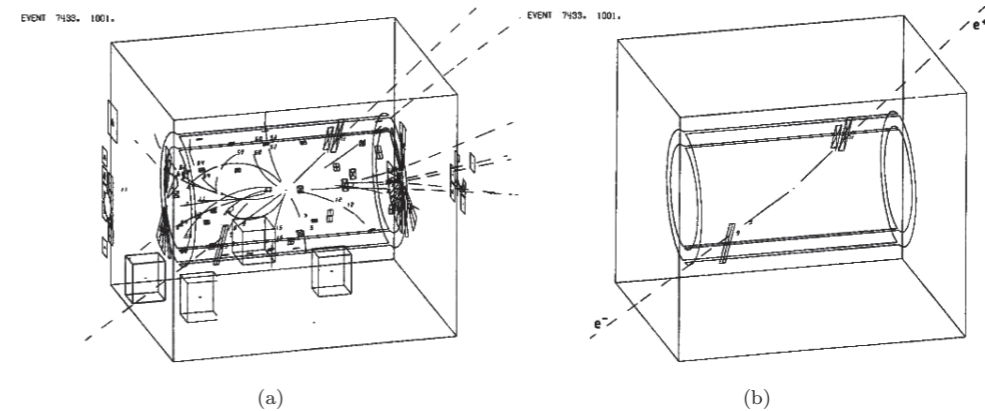
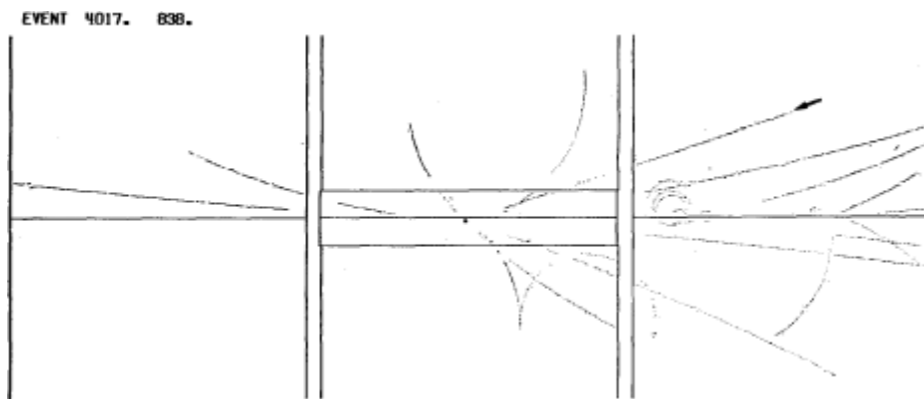

Higgs boson

But a theory with massive spin-1 mediators also predicts probabilities > 1 ...

One solution is an additional neutral particle that gives mass to everything (Higgs boson) (this sounds mystical, but it's not, we will make it absolutely precise by the end of this course)

Combination of ideas from condensed matter and high-energy physics:

Anderson, Higgs, Brout, Englert, Guralnik, Kibble, ...

The only problem is, the theory doesn't predict its mass!

Can bound it from below and above,
and after decades of searching (and many failed experiments)...

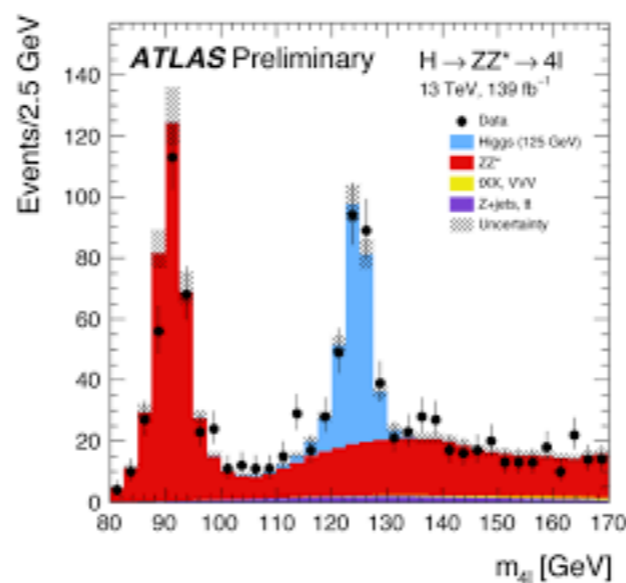
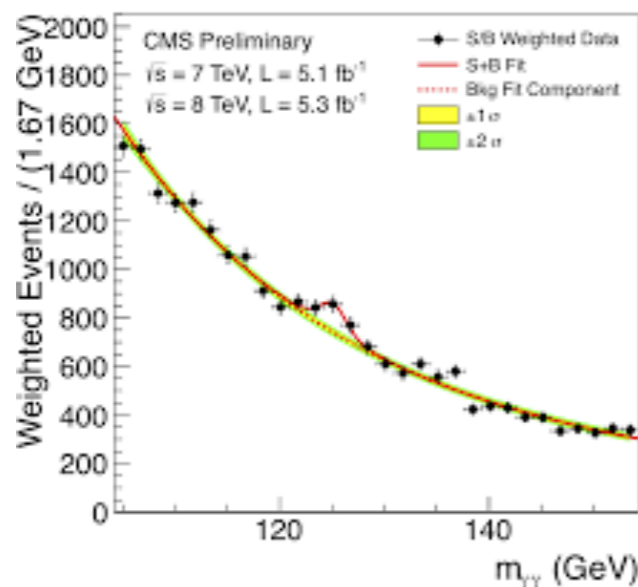

Discovered at CERN in 2012! Nobel prize for Higgs, Englert in 2013.

(I was in grad school and stayed up until 3am to watch the press conference)

Review of the nomenclature

Leptons = electron, muon, tau
(sometimes “charged leptons” since neutrinos are technically leptons)

Mesons = quark-antiquark bound states (in this course, we will really only ever talk about pions)

Baryons = 3-quark bound states (focus of PHYS 570, we will only talk about protons/neutrons)

Hadrons = anything containing quarks (mesons and baryons)

Vector bosons or **mediators** = gluon, photon, W/Z
(will explain this terminology in a few lectures)

All data so far indicate every particle in this chart is fundamental (point-like, no substructure)

This story is almost certainly not complete...where is dark matter in this picture?

But we'll leave that for the last few weeks of this class.

